

港湾技研資料

TECHNICAL NOTE OF
THE PORT AND HARBOUR RESEARCH INSTITUTE
MINISTRY OF TRANSPORT, JAPAN

No. 619 June 1988

STRONG-MOTION EARTHQUAKE RECORDS ON
THE 17 DECEMBER 1988 CHIBA-KEN-TOHO-OKI EARTHQUAKE IN PORT AREAS

昭和62年12月17日 千葉県東方沖地震の港湾地域における強震記録

倉	田	柴	一
野	田	節	男
桶	口	豊	志

運輸省港湾技術研究所



**STRONG-MOTION EARTHQUAKE RECORDS ON
THE 17 DECEMBER 1987 CHIBA-KEN-TOHO-OKI EARTHQUAKE IN PORT AREAS**

Contents

Synopsis

1. Introduction	3
2. Earthquakes	3
3. Stations	4
4. Digitization and Analyses	7
References	7
Observation Results and Preliminary Analyses	11
1. Strong-motion Earthquake Observation Results	13
2. Reproduced Accelerograms	14
(1) S-2106 Koken-S (AR, IR, RS, FS, NR, LO)	14
(2) S-2107 Chiba-S (AR, IR, RS, FS, NR, LO)	28
(3) S-2110 Kashima-zokan-S (AR, IR, RS, FS, NR, LO)	42
(4) S-2111 Shinagawa-S (AR, IR, RS, FS, NR, LO)	56
(5) S-2112 Keihin-ji-S (AR, IR, RS, FS, NR, LO)	70
(6) S-2113 Yamashita-hen-S (AR, IR, RS, FS, NR, LO)	84
(7) M-1183 Yamashita-han-M (AR, IR, RS, FS, NR, LO)	98
(8) F-95 Yamashita-F (AR, IR, RS, FS, NR, LO)	112
(9) F-98 Kawasaki-F (AR, IR, RS, FS, NR, LO)	126
3. Digitized Records	140
(1) S-2106 Koken-S	140
(2) S-2107 Chiba-S	157
(3) S-2110 Kashima-zokan-S	175
(4) S-2111 Shinagawa-S	193
(5) S-2112 Keihin-ji-S	210
(6) S-2113 Yamashita-han-S	228
(7) M-1183 Yamashita-hen-M	246
(8) F-95 Yamashita-F	264
(9) F-98 Kawasaki-F	282

***Abbreviations used above:**

- AR : Analog record (computer plots of digitized records)
- IR : Integrated velocities and displacements (computer plots of digitized records)
- RS : Response spectra
- FS : Fourier spectra
- NR : Numerical table of response spectra
- LO : Loci of accelerations, velocities and displacements

昭和62年12月17日千葉県東方沖地震の港湾地域における強震記録

倉田 栄一*

野田 節男**

樋口 豊志*

要 旨

昭和62年12月17日千葉県東方沖に震源をもつマグニチュード6.7の地震が発生した。首都圏では千葉、銚子、勝浦において気象庁震度階Vを記録するなど各地で強い地震動が観測され、木造家屋等に被害が発生した。港湾施設に被害は生じないものの、千葉港、東京港の埋立地等において液状化現象が認められた。

港湾地域強震観測網では9港15地点において地震動を記録した。千葉港における最大地盤加速度は東西成分171ガル、南北成分161ガル、上下成分57ガルであった。港湾地域の地震防災対策を推進するにあたって今回の地震による強震記録は液状化の予測法の検証をはじめ各方面にわたり工学的に有用な情報を提供するものと考えられる。

本資料は当該地震による強震記録の観測表、最大加速度、および20ガル以上の地盤の記録について以下の内容を含む。

1. 加速度波形
2. 積分により求めた速度および変位波形
3. 応答スペクトル
4. フーリエスペクトル
5. 加速度、速度、変位の軌跡

また、最大加速度が50ガル以上の9記録については加速度数値表を示した。これは計器特性の補正を行っていない数値である。以上の図表は「港湾地域強震観測年報（1986）」、「昭和59年8月7日日向灘地震の港湾地域における強震観測」に準じたものである。

キーワード：強震観測，加速度数値化記録，応答スペクトル

*構造部 耐震構造研究室

**構造部 耐震構造研究室室長

STRONG-MOTION EARTHQUAKE RECORDS ON THE 17 DECEMBER 1987 CHIBA-KEN-TOHO-OKI EARTHQUAKE IN PORT AREAS

Eiichi KURATA*
Setsuo NODA**
Toyoshi HIGUCHI*

Synopsis

This report presents the strong-motion earthquake records of the 17 December 1987 Chiba-Ken-Toho-Oki Earthquake in port areas in Japan. Event data of the earthquake are listed with the maximum component accelerations of all the records obtained in the network of the Port and Harbour Research Institute. 9 records of them are presented as acceleration time histories, integrated velocities and displacements, response spectra, Fourier spectra, and loci of accelerations, velocities and displacements. Listings of the digitized records are presented for 9 records. This report has almost the same format and almost the same procedures for data processing as preceding annual reports.

1. Introduction

On December 17, 1987 an earthquake of magnitude 6.7 hit the metropolitan area in Japan. The epicenter was located at coast of Kujukuri in Chiba prefecture. This earthquake brought very strong shocks in the area and damages on various kind of facilities such as wooden houses and bridges. Port facilities were not damaged but liquefaction of reclaimed lands occurred in some places in Chiba port and Tokyo port.

The earthquake triggered 19 strong-motion accelerographs at 9 ports of the network of the Port and Harbour Research Institute (PHRI). The peak ground accelerations at Chiba port are 171 Gals in EW component. These strong-motion records may offer useful information for investigating many subjects of earthquake engineering such as liquefaction of ground.

The strong-motion earthquake records from the PHRI network were used to be published as annual reports (1 through 20 in references) except six special reports on the great earthquakes (21 through 26 in references). This report is the seventh special compilation of the records which may serve a convenience to the users with special interest in this earthquake.

This report presents followings on the strong-motion earthquake records, from the PHRI network, on the 17 December 1987 Chiba-Ken-Toho-Oki earthquake;

- i) Strong-motion Earthquake Observation Results (They are lists of event data and all the strong-motion earthquake records recovered in the PHRI network)
- ii) Analog reproductions of original records.
- iii) Instrument corrected accelerations, integrated velocities and integrated displacements.
- iv) Response spectra of instrument corrected accelerations (Figures and numerical tables)
- v) Fourier spectra of instrument corrected accelerations.
- vi) Loci of accelerations, velocities and displacements in horizontal plains.
- vii) Listings of original digitized records without instrument correction.

Key Words : Strong-motion Earthquake Observation, Digitized Acceleration Records, Response Spectra

*Members of Earthquake Resistant Structures Laboratory, Structures Division

**Chief of Earthquake Resistant Structures Laboratory, Structures Division

The format of the publication and the procedures for data processing are almost identical with those of the preceding annual report (21) except a few points to be described in the following sections of this report.

The strong-motion earthquake observation in port areas in Japan has been being performed by the PHRI in co-operation with the following organizations:

Bureau for Ports and Harbours, Ministry of Transport;
Regional Bureaus for Port Construction, Ministry of Transport;
Port and Harbour Division, Hokkaido Development Bureau, Hokkaido Development Agency;
Okinawa General Office, Okinawa Development Agency; and
Harbour Bureau (Sections) of Prefectural Governments (Tokyo, Osaka, Shizuoka and Miyazaki).

2. Earthquakes

The event data of the earthquake are presented in "Strong-Motion Earthquake Observation Results" together with the maximum component accelerations of the records. The location of epicenter of the main shock and seismic intensities in the JMA intensity scale at various places are presented in Fig. 1. The Roman numerals in the figure indicate the seismic intensities. The JMA seismic intensity scale is given in Table 1. The event data are based upon the publication of JMA (35).

Table 1 JMA Seismic Intensity Scale (After Ref. 35)

O	: NO FEELING	Shocks too weak to cause human feelings and registered only by a seismograph.
I	: SLIGHT	Extremely feeble shocks only felt by persons at rest or by those who are observant to an earthquake.
II	: WEAK	Shocks felt by most persons, slight shaking of doors and Japanese latticed sliding doors (shoji).
III	: RATHER STRONG	Slight shaking of houses and buildings, rattling of doors and Japanese latticed sliding doors (shoji), swinging of hanging objects like electric lamps, moving of liquids in vessels.
IV	: STRONG	Strong shaking of houses and buildings, overturning of unstable objects, spilling of liquids out of vessels.
V	: VERY STRONG	Cracks in the walls, overturning of gravestones, stone lanterns etc., damage to chimneys and mud-and-plaster warehouse.
VI	: DISASTROUS	Demolition of houses by less than 30% in total number, landslips, fissures in the ground etc.
VII	: VERY DISASTROUS	Demolition of houses by more than 30%, intense landslips, large fissures in the ground faults.

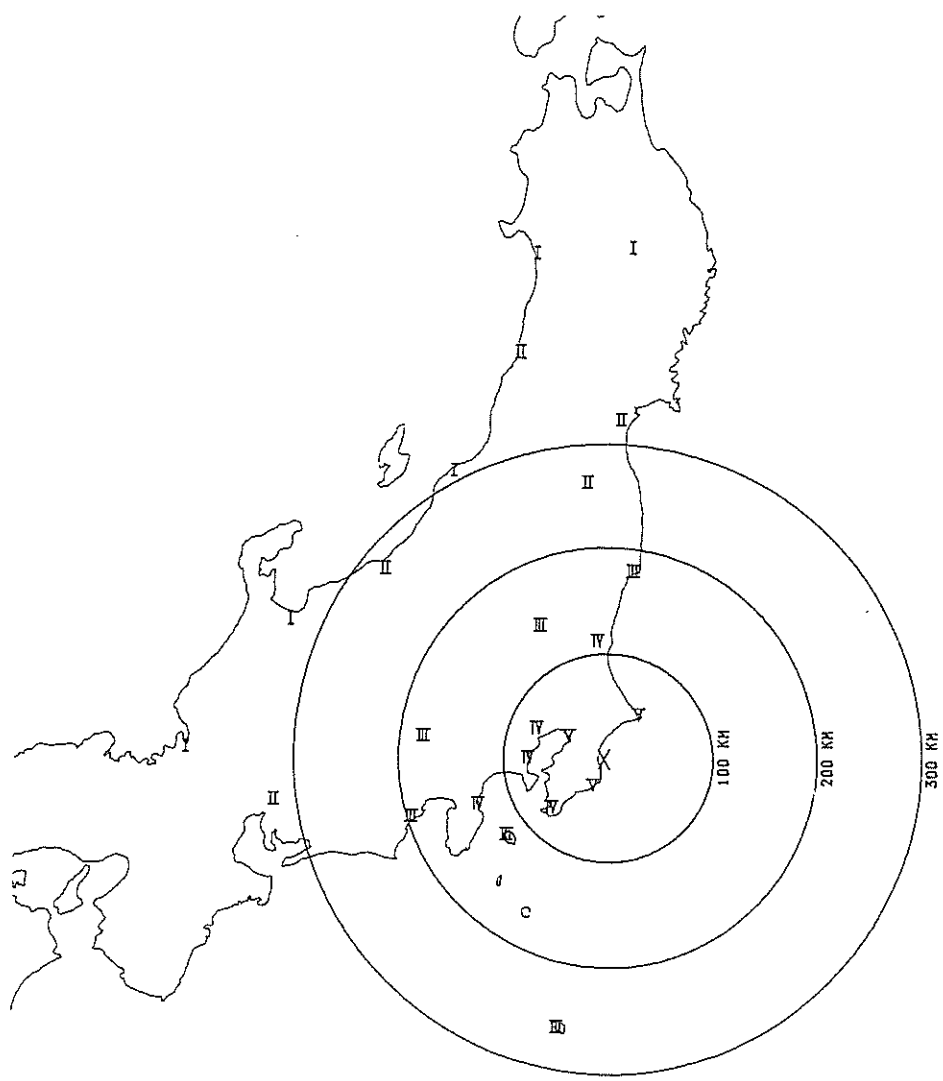

Fig. 1 Epicenter and Seismic Intensities of Main Shock of Decembr, 17, 1987 (11:08)

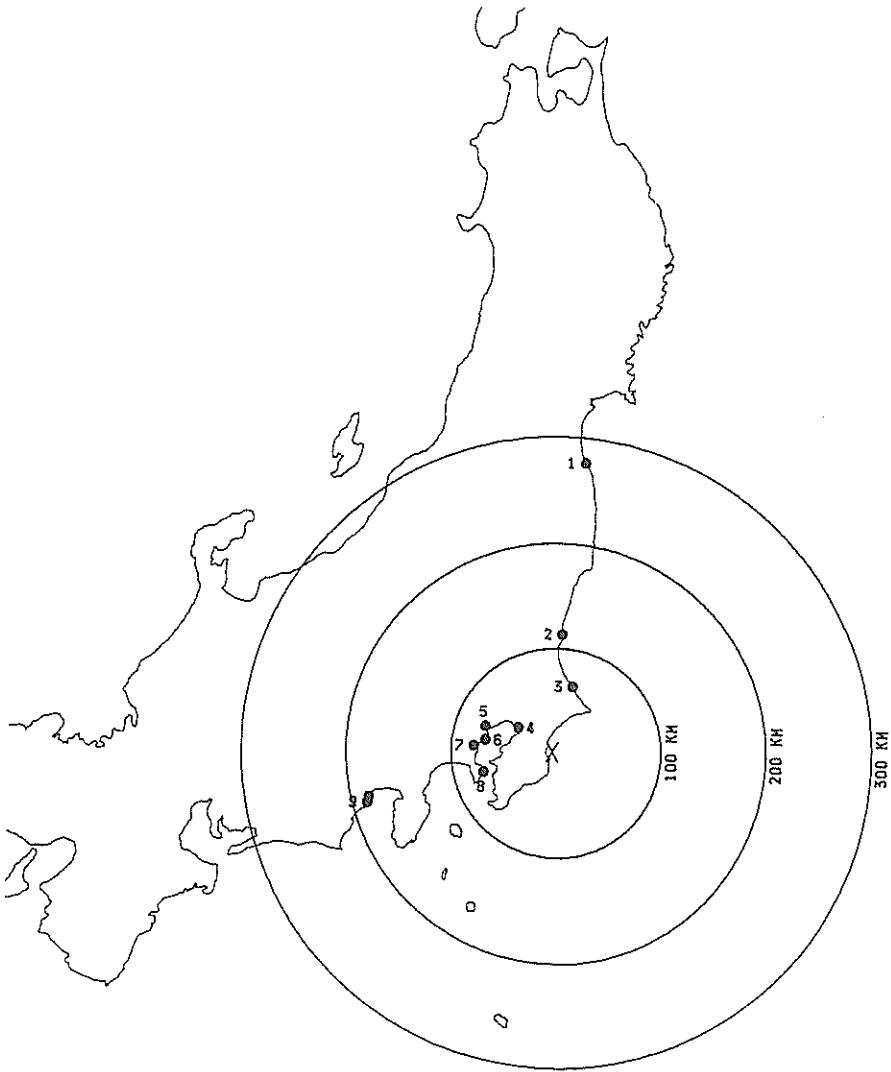

Fig. 2 Location of Stations of PHRI Network

3. Stations

The strong-motion earthquake observation stations of the PHRI network are shown in Table 2. The stations in the table are limited to those recording this earthquake. The ports where the stations are located are also indicated in Fig. 2 with Arabic numerals, which are corresponding with the port numbers in Table 2. Installation condition and accelerograph type of each station are also given in Table 2.

The accelerographs of the PHRI network are the SMAC-B2 accelerograph and the ERS accelerograph. Detailed description on instrument characteristics is available in the previous annual reports (For example, Reference 21).

Site data of the stations have been published separately (28 through 32). Table 2 includes the number of Technical Note of PHRI in which the site data of each station are presented.

4. Digitization and Analyses

The digitized records without instrument correction are provided on the accelerograms of ground motions with a peak acceleration exceeding 50 Gals in the same manner as in the annual report series.

The procedure to digitize the accelerograms, to correct and integrate the records, and to calculate the response spectra are mostly identical with those described in the preceding annual report (21). The correction for start up of recording paper drive of the SMAC-B2 accelerograph is same as was described in the preceding special report (21).

The descriptions in details on the digitization and the corrections are available in separate reports (33) and (34) as well as in the preceding annual reports.

The loci of acceleration and displacement in horizontal plane are also included in this report. The records used for calculation are instrument corrected accelerations, velocities and displacement processed by the variable filler.

Table 2 Strong-motion Earthquake Stations of PHRI, Recording the Main Shock

No. of port*	Name of port	Name of station	Type of accelerographs	Installation condition	Ref.No.**
1	Soma Port	Soma-S	SMAC-B2	on ground	
2	Hitachinaka Port	Hitachinaka-F	ERS-F	on ground	
3	Kashima Port	Kashima-zokan-S	SMAC-B2	on ground	298
4	Chiba Port	Chiba-S	SMAC-B2	on ground	107
5	Tokyo Port	Shinagawa-S	SMAC-B2	on ground	107
		Shinagawa-MB	ERS-D	in ground	
6	Kawasaki Port	Kawasaki-FB	ERS-F	in ground	
		Kawasaki-F	ERS-F	on ground	
		Kawasaki-FR	ERS-F	on structure	
7	Yokohama Port	Keihin-ji-S	SMAC-B2	on ground	34
		Yamashita-hen-S	SMAC-B2	on ground	34
		Yamashita-dai6-S	SMAC-B2	on structure	34
		Yamashita-hen-M	ERS-C	on ground	298
		Yamashita-FB	ERS-F	in ground	
		Yamashita-F	ERS-F	on ground	
		Yamashita-FR	ERS-F	on structure	
8	Yokosuka Port	Koken-S	SMAC-B2	on ground	34
9	Shimizu Port	Okitsu-S	SMAC-B2	on ground	298
		Shmizu-kojyo-S	SMAC-B2	on ground	156
		Shmizu-miho-S	SMAC-B2	on ground	298

*The numbers correspond to those in Fig. 2.

**The numbers correspond to those of the Technical Note of the Port and Harbour Research Institute in which the site condition of the station is given.

(Received on March 31, 1988)

References

- 1) Hajime Tsuchida, Teiichiro Yamada, Eiichi Kurata and Katsuko Sudo: Annual Report on Strong-Motion Earthquake Records in Japanese Ports (1963 and 1964), *Technical Note of the Port and Harbour Research Institute*, No. 55, September 1968, 86p.
- 2) Hajime Tsuchida, Teiichiro Yamada, Eiichi Kurata and Katsuko Sudo: Annual Report on Strong-Motion Earthquake Records in Japanese Ports (1965 and 1966), *Technical Note of the Port and Harbour Research Institute*, No. 62, December 1968, 145p.
- 3) Hajime Tsuchida, Eiichi Kurata and Katsuko Sudo: Annual Report on Strong-Motion Earthquake Records in Japanese Ports (1967), *Technical Note of the Port and Harbour Research Institute*, No. 64, March 1969, 182p.
- 4) Hajime Tsuchida, Eiichi Kurata and Katsuko Sudo: Annual Report on Strong-Motion Earthquake Records in Japanese Ports (1968), *Technical Note of the Port and Harbour Research Institute*, No. 98, March 1970, 342p.
- 5) Hajime Tsuchida, Eiichi Kurata and Katsuko Sudo: Annual Report on Strong-Motion Earthquake Records in Japanese Ports (1969), *Technical Note of the Port and Harbour Research Institute*, No. 100, June 1970, 86p.
- 6) Hajime Tsuchida, Eiichi Kurata and Katsuko Sudo: Annual Report on Strong-Motion Earthquake Records in Japanese Ports (1970), *Technical Note of the Port and Harbour Research Institute*, No. 116, March 1971, 171p.
- 7) Eiichi Kurata, Tokuzo Ishizaka and Hajime Tsuchida: Annual Report on Strong-Motion Earthquake Records in Japanese Ports (1971), *Technical Note of the Port and Harbour Research Institute*, No. 136, March 1972, 195p.
- 8) Eiichi Kurata, Tokuzo Ishizaka and Hajime Tsuchida: Annual Report on Strong-Motion Earthquake Records in Japanese Ports (1972), *Technical Note of the Port and Harbour Research Institute*, No. 160, March 1973, 206p.
- 9) Eiichi Kurata, Tokuzo Ishizaka and Hajime Tsuchida: Annual Report on Strong-Motion Earthquake Records in Japanese Ports (1973), *Technical Note of the Port and Harbour Research Institute*, No. 181, March 1974, 152p.
- 10) Eiichi Kurata, Tokuzo Ishizaka and Hajime Tsuchida: Annual Report on Strong-Motion Earthquake Records in Japanese Ports (1974), *Technical Note of the Port and Harbour Research Institute*, No. 202, March 1975, 124p.
- 11) Eiichi Kurata, Susumu Iai and Hajime Tsuchida: Annual Report on Strong-Motion Earthquake Records in Japanese Ports (1975), *Technical Note of the Port and Harbour Research Institute*, No. 236, March 1976, 64p.
- 12) Eiichi Kurata, Susumu Iai and Hajime Tsuchida: Annual Report on Strong-Motion Earthquake Records in Japanese Ports, Supplementary (1973 through 1975, Vertical component), *Technical Note of the Port and Harbour Research Institute*, No. 250, December 1976, 290p.

- 13) Eiichi Kurata, Susumu Iai and Hajime Tsuchida: Annual Report on Strong-Motion Earthquake Records in Japanese Ports (1976 and 1977), *Technical Note of the Port and Harbour Research Institute*, No.287, March 1978, 194p.
- 14) Eiichi Kurata, Susumu Iai, Yoshiko Yokoyama and Hajime Tsuchida: Annual Report on Strong-Motion Earthquake Records in Japanese Ports (1978 and 1979), *Technical Note of the Port and Harbour Research Institute*, No. 338, June 1980, 256p.
- 15) Eiichi Kurata, Susumu Iai, Yoshiko Yokoyama and Setsuo Noda: Annual Report on Strong-Motion Earthquake Records in Japanese Ports(1980), *Technical Note of the Port and Harbour Research Institute*, No. 374, June 1981, 519p.
- 16) Eiichi Kurata and Setsuo Noda: Annual Report on Strong-Motion Earthquake Records in Japanese Ports (1981), *Technical Note of the Port and Harbour Research Institute*, No. 426, June 1982, 191p.
- 17) Eiichi Kurata, Tetsuo Fukuhara and Setsuo Noda: Annual Report on Strong-Motion Earthquake Records in Japanese Ports(1982), *Technical Note of the Port and Harbour Research Institute*, No. 446, June 1983, 183p.
- 18) Eiichi Kurata, Tetsuo Fukuhara and Setsuo Noda: Annual Report on Strong-Motion Earthquake Records in Japanese Ports(1983), *Technical Note of the Port and Harbour Research Institute*, No. 487, June 1984, 411p.
- 19) Eiichi Kurata, Tetsuo Fukuhara and Setsuo Noda: Annual Report on Strong-Motion Earthquake Records in Japanese Ports (1984), *Technical Note of the Port and Harbour Research Institute*, No. 519, June 1985, 154p.
- 20) Eiichi Kurata, Tetsuo Fukuhara and Setsuo Noda: Annual Report on Strong-Motion Earthquake Records in Japanese Ports(1985), *Technical Note of the Port and Harbour Research Institute*, No. 547, June 1986, 355p.
- 21) Eiichi Kurata, Tetsuo Fukuhara and Setsuo Noda: Annual Report on Strong-Motion Earthquake Records in Japanese Ports(1986), *Technical Note of the Port and Harbour Research Institute*, No. 588, June 1987, 370p.
- 22) Hajime Tsuchida, Eiichi Kurata and Katsuko Sudo: Strong-Motion Earthquake Records on the 1968 Tokachi-Oki Earthquake and Its Aftershocks, *Technical Note of the Port and Harbour Research Institute*, No. 80, June 1969, 476p.
- 23) Eiichi Kurata, Susumu Iai and Hajime Tsuchida: Strong-Motion Earthquake Records on the 1978 Izu-Oshima-Kinkai Earthquake in Port Areas, *Technical Note of the Port and Harbour Research Institute*, No. 317, March 1979, 383p.
- 24) Eiichi Kurata, Susumu Iai, Yoshiko Yokoyama and Hajime Tsuchida: Strong-Motion Earthquake Records on the 1978 Miyagi-Ken-Oki Earthquake in Port Areas, *Technical Note of the Port and Harbour Research Institute*, No. 319, June 1979, 419p.
- 25) Eiichi Kurata and Setsuo Noda: Strong-Motion Earthquake Records on the 1982 Urakawa-Oki Earthquake in Port Areas, *Technical Note of the Port and Harbour Research Institute*, No. 442, March, 1983, 144p.

- 26) Eiichi Kurata, Tetsuo Fukuhara and Setsuo Noda: Strong-Motion Earthquake Records on the 1983 Nipponkai-Chubu Earthquake in Port Areas, *Technical Note of the Port and Harbour Research Institute*, No. 458, September 1983, 327p.
- 27) Eiichi Kurata, Tetsuo Fukuhara and Setsuo Noda: Strong-Motion Earthquake Records on the 7 August 1984 Hyuganada Earthquake in Port Areas, *Technical Note of the Port and Harbour Research Institute*, No. 503, December 1984, 113p.
- 28) Hajime Tsuchida, Teiichiro Yamada and Eiichi Kurata: Site Characteristics of Strong-Motion Earthquake Stations in Ports and Harbours in Japan (Part 1), *Technical Note of the Port and Harbour Research Institute*, No.34, November 1967, 306p.
- 29) Eiichi Kurata, Hajime Tsuchida and Katsuko Sudo: Site Characteristics of Strong-Motion Earthquake Stations in Ports and Harbours in Japan (Part 2), *Technical Note of the Port and Harbour Research Institute*, No. 107, December 1970, 87p.
- 30) Eiichi Kurata and Tokuzo Ishizaka: Site Characteristics of Strong-Motion Earthquake Stations in Ports and Harbours in Japan (Part 3), *Technical Note of the Port and Harbour Research Institute*, No.156, March 1973, 54p.
- 31) Yoshiko Yokoyama and Eiichi Kurata: Site Characteristics of Strong-Motion Earthquake Stations in Ports and Harbours in Japan (Part 4), *Technical Note of the Port and Harbour Research Institute*, No. 298, June 1978, 110p.
- 32) Yoshiko Yokoyama and Eiichi Kurata: Site Characteristics of Strong-Motion Earthquake Stations in Ports and Harbours in Japan (Part 5), *Technical Note of the Port and Harbour Research Institute*, No. 351, September 1980, 72p.
- 33) Susumu Iai, Eiichi Kurata and Hajime Tsuchida: Digitization and Correction of Strong-Motion Accelerograms, *Technical Note of the Port and Harbour Research Institute*, No. 286, March 1978, 286p.
- 34) Susumu Iai and Eiichi Kurata: Integration of Strong-Motion Accelerograms, *Proceedings of the 5th Japan Earthquake Engineering Symposium*, November 1978, pp.225~232.
- 35) The Seismological Bulletin of the Japan Meteorological for January 1987, The Japan Meteorological Agency, 1987.
- 36) Naba C. Nigam and Paul C. Jennings: Calculation of Response Spectra from Strong-Motion Earthquake Records, *Bulletin of the Seismological Society of America*, Vol. 59, No. 2, April 1969, pp.909~922.
- 37) Hajime Tsuchida: Present State and Outcomes of Strong-Motion Earthquake Observation in Port Areas in Japan, *Proceeding of the Annual Research Conference of the Port and Harbour Research Institute*, December 1979, pp.127~195.

Observation Results

and

Preliminary Analyses

STRONG-MOTION EARTHQUAKE OBSERVATION RESULTS

11:08 DEC. 17, 1987
 CHIBA-KEN-TOHO-OKI
 EPICENTER : 35° 22' N 140° 30' E
 DEPTH : 58KM MAGNITUDE : 6.7

JMA INTENSITIES
 V : CHIBA, CHOSHI, KATSUURA
 IV : MITO, TOKYO, YOKOHAMA,
 TATEYAMA, AJIRO
 III : ONAHAMA, UTSUNOMIYA,
 ASHIMA, SHIZUOKA, KOFU,
 HACHIJOJIMA
 II : SENDAI, FUKUSHIMA, NAGOYA,
 SAKATA, TAKADA
 I : AKI TA, NIIGATA, TOYAMA,
 TSURUGA, MORIOKA

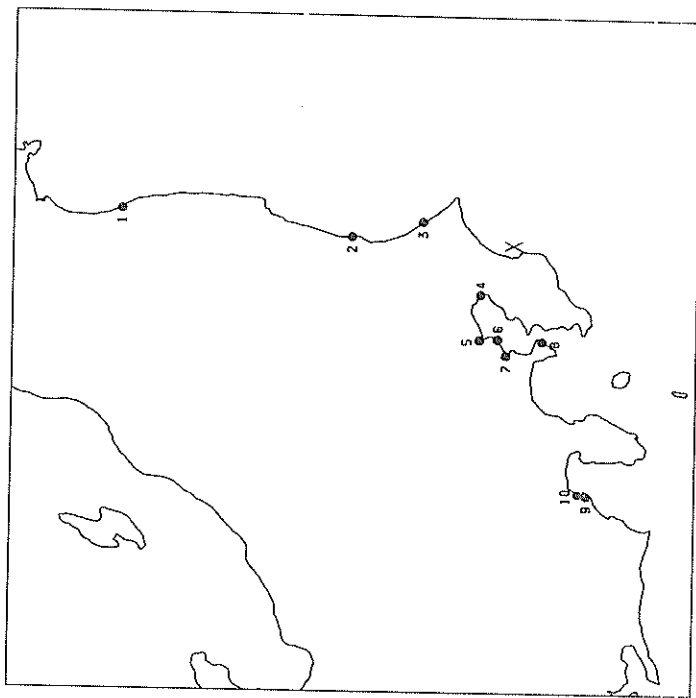

STATION	CONDITION	RECORD NUMBER	MAX. ACC. (NS) [EW] [UD]	DIST. (KM)
1 SDMA-S	ON GROUND	S-2109	3 3 2	277
2 HITACHINAKA-F	ON GROUND	F- 93	36 39 18	114
3 KASHIMA-ZOKAN-S	ON GROUND	S-2110	111 81 32	65
4 CHIBA-S	ON GROUND	S-2107	171 169 60	44
5 SHINAGAWA-S	ON GROUND	S-2111	109 88 19	73
6 KAWASAKI-FB	IN GROUND	M-1182	26 24 20	73
7 KAWASAKI-F	IN GROUND	F- 97	54 36 15	69
8 KAWASAKI-FR	ON GROUND	F- 98	86 90 27	69
9 KEIIN-JI-S	ON STRUC.	F- 99	115 110 36	69
10 YAMASHITA-HEN-S	ON GROUND	S-2112	53 48 22	79
11 YAMASHITA-DAI6-S	ON GROUND	S-2113	91 69 14	77
12 YAMASHITA-FB	IN GROUND	S-2114	79 101 20	76
13 YAMASHITA-F	ON GROUND	F- 94	22 23 20	76
14 YAMASHITA-FR	ON GROUND	F- 95	62 131 35	76
15 KOKEN-S	ON STRUC.	F- 96	256 189 30	76
16 SHIMIZU-KOJYO-S	ON GROUND	S-2106	69 75 23	72
17 OKITSU-S	ON GROUND	S-2115	11 18 6	186
18 SHIMIZU-MIHO-S	ON GROUND	S-2116	4 5 2	184
19 YAMASHITA-HEN-M	ON GROUND	S-2117	9 8 3	184
20 YAMASHITA-HEN-M	ON GROUND	M-1183	95 70 19	77

RECORD NUMBER
STATION

S-2106

KOKEN-S

EARTHQUAKE DATA

DATA AND TIME
LOCATION OF HYPOCENTER
EPCENTRAL REGION
LATITUDE
LONGITUDE
DEPTH
MAGNITUDE

11: 8 DEC.17,1987

CHIBA-KEN-TOHO-OKI

35°22' N

140°30' E

58KM

6.7

PEAK VALUES OF COMPONENTS

N S E W U D HORIZONTAL*

PARAMETER OF THE VARIABLE FILTER

FC (HZ) 0.268 0.390 0.500

MAXIMUM ACCELERATION (GAL)

ORIGINAL 71.1 70.2 25.4 73.4
CORRECTED 82.7 84.9 34.8 98.3

MAXIMUM VELOCITY (CM/SEC)

FIXED FILTER 5.47 6.00 1.70 6.33
VARIABLE FILTER 5.36 5.70 1.80 5.79

MAXIMUM DISPLACEMENT (CM)

FIXED FILTER 1.516 1.207 0.638 1.565
VARIABLE FILTER 0.908 0.507 0.130 0.917

* RESULTANT OF HORIZONTAL COMPONENTS

S-2106 KOKEN-S

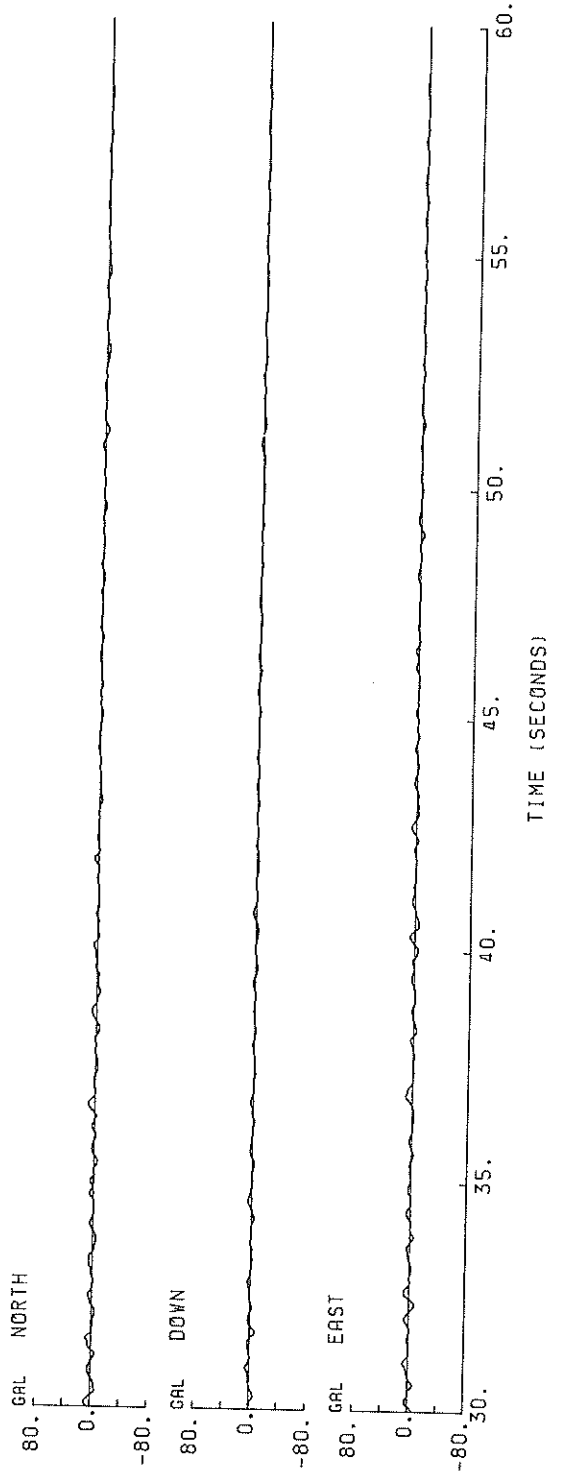
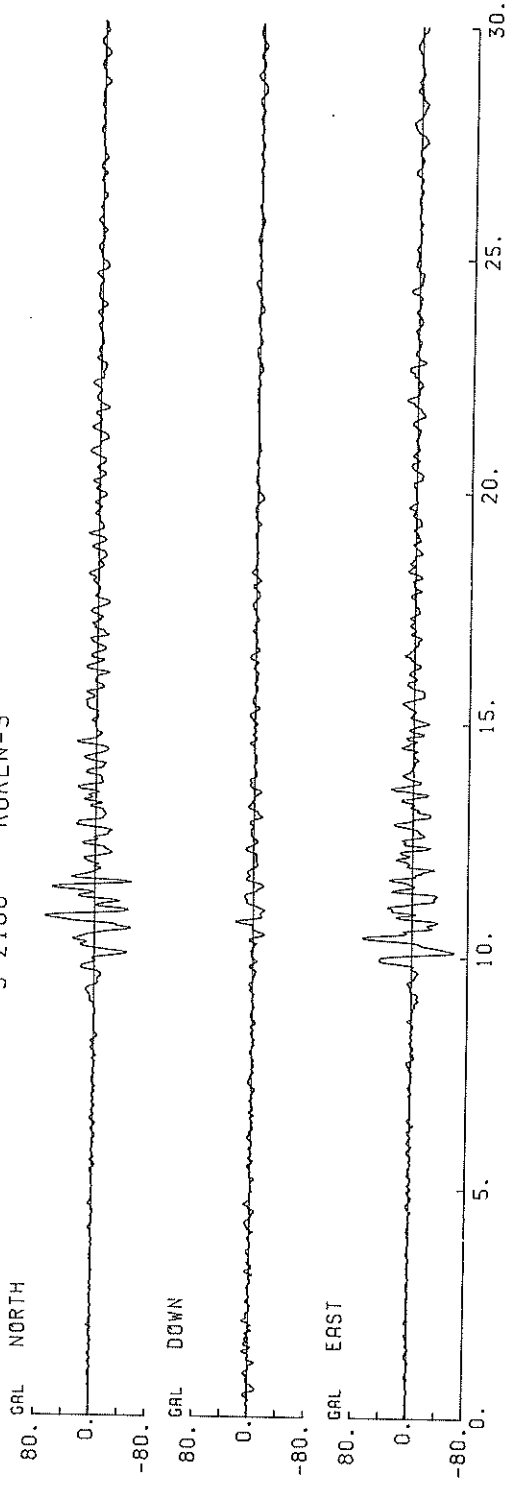

S-2106 NORTH KOKEN-S

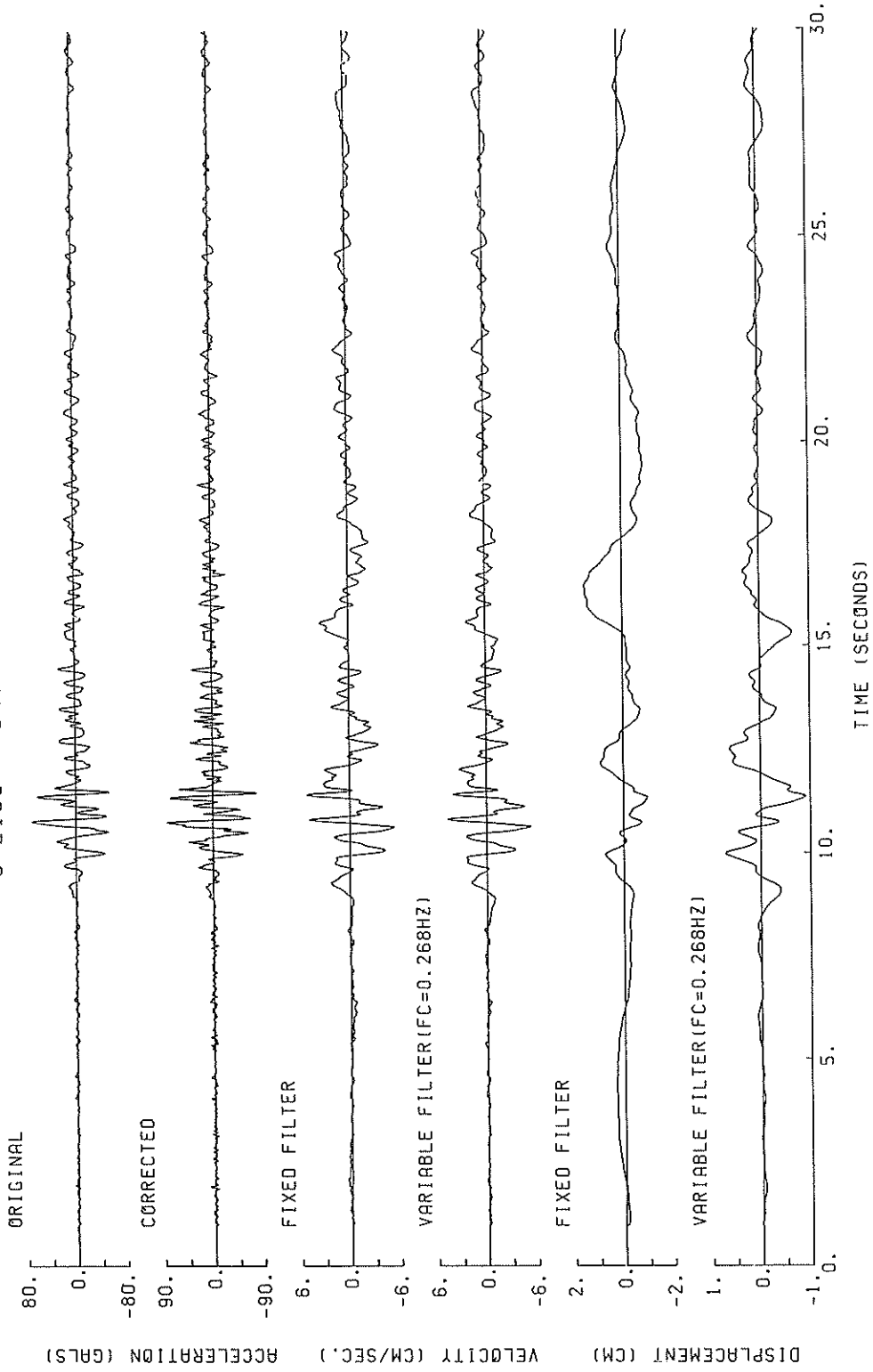

S-2106 NORTH KOKEN-S

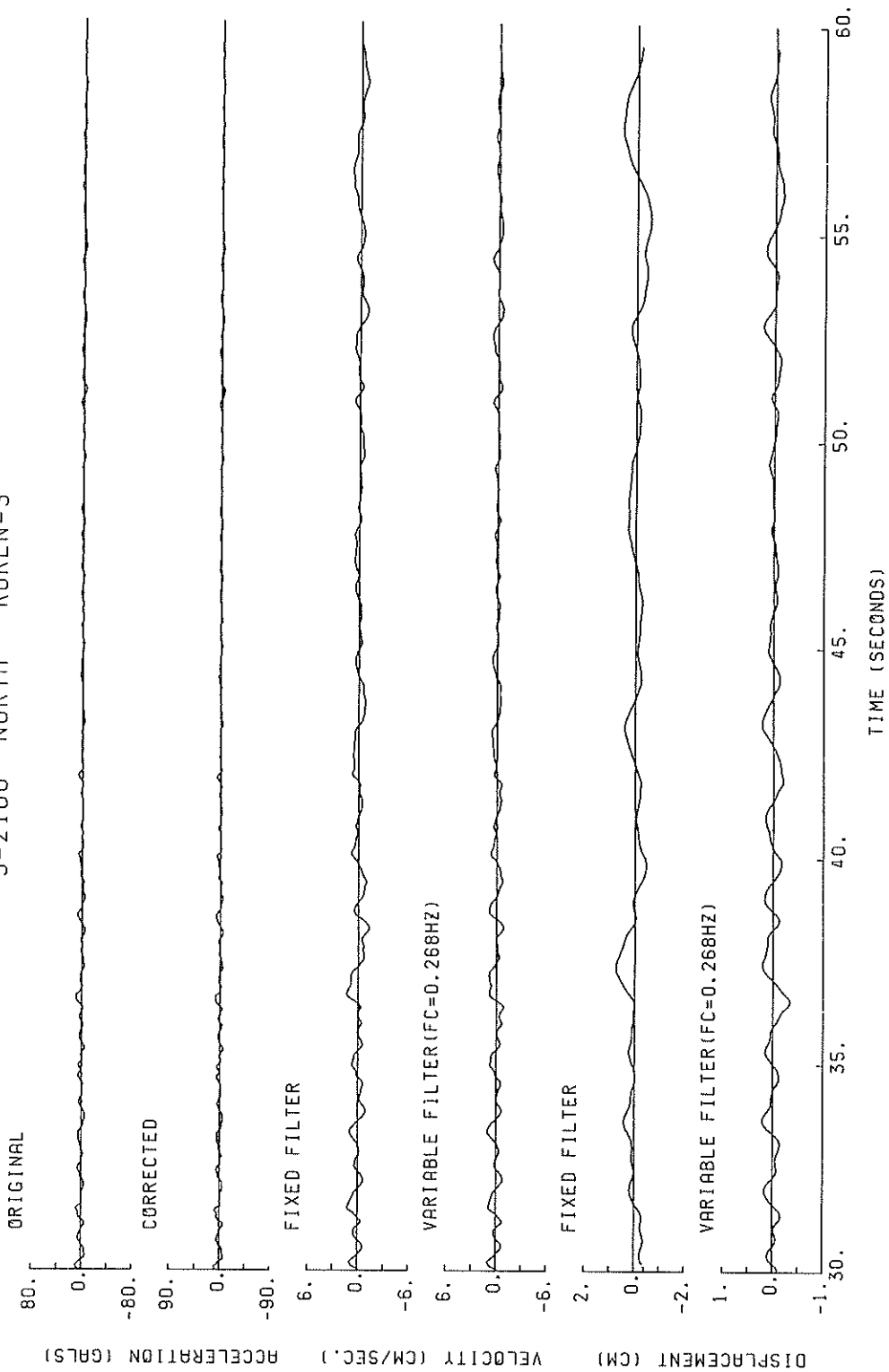

S-2106 EAST KOKEN-S

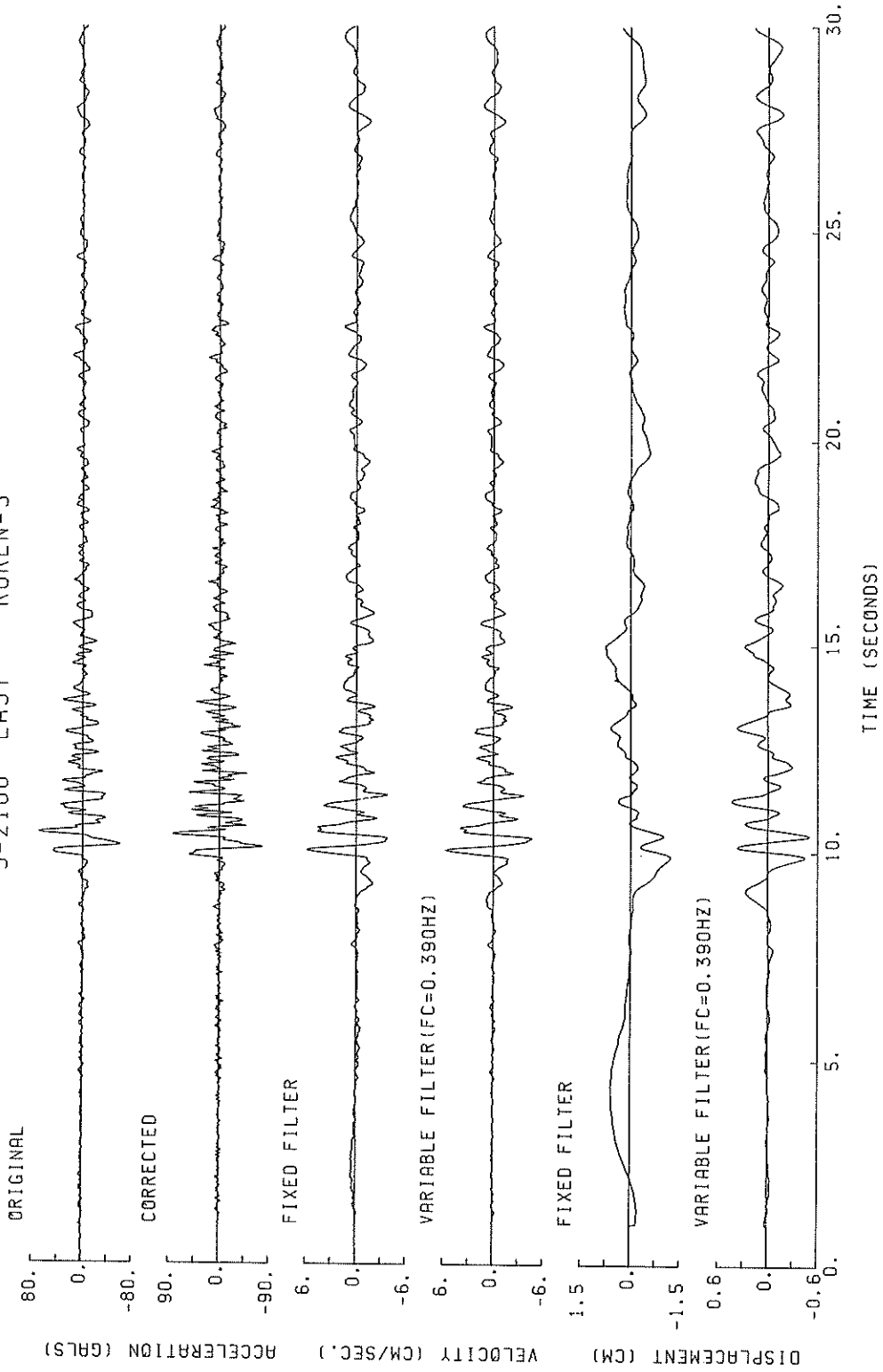

S-2106 EAST KOKEN-S

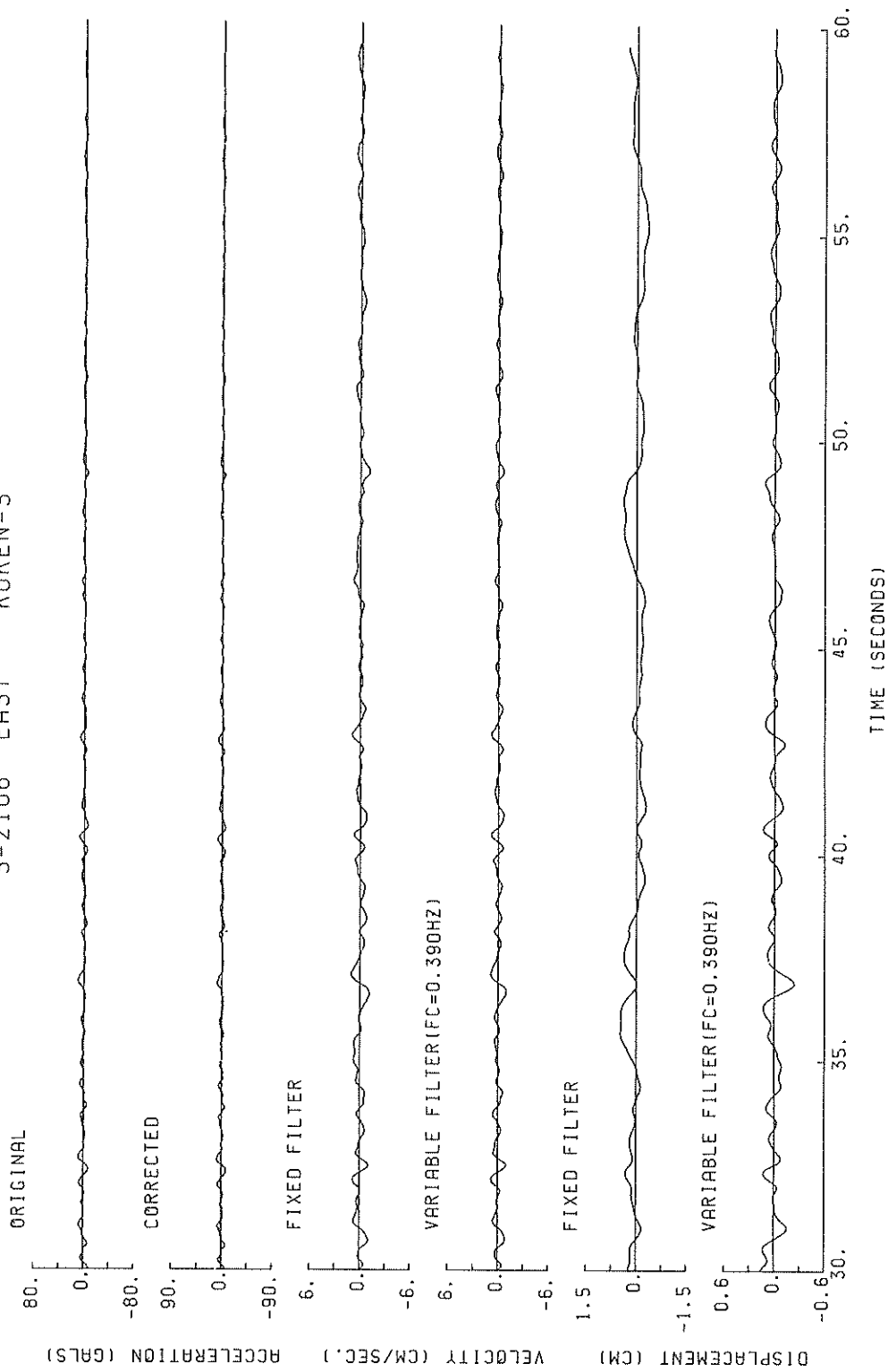

S-2106 DOWN KOKEN-S

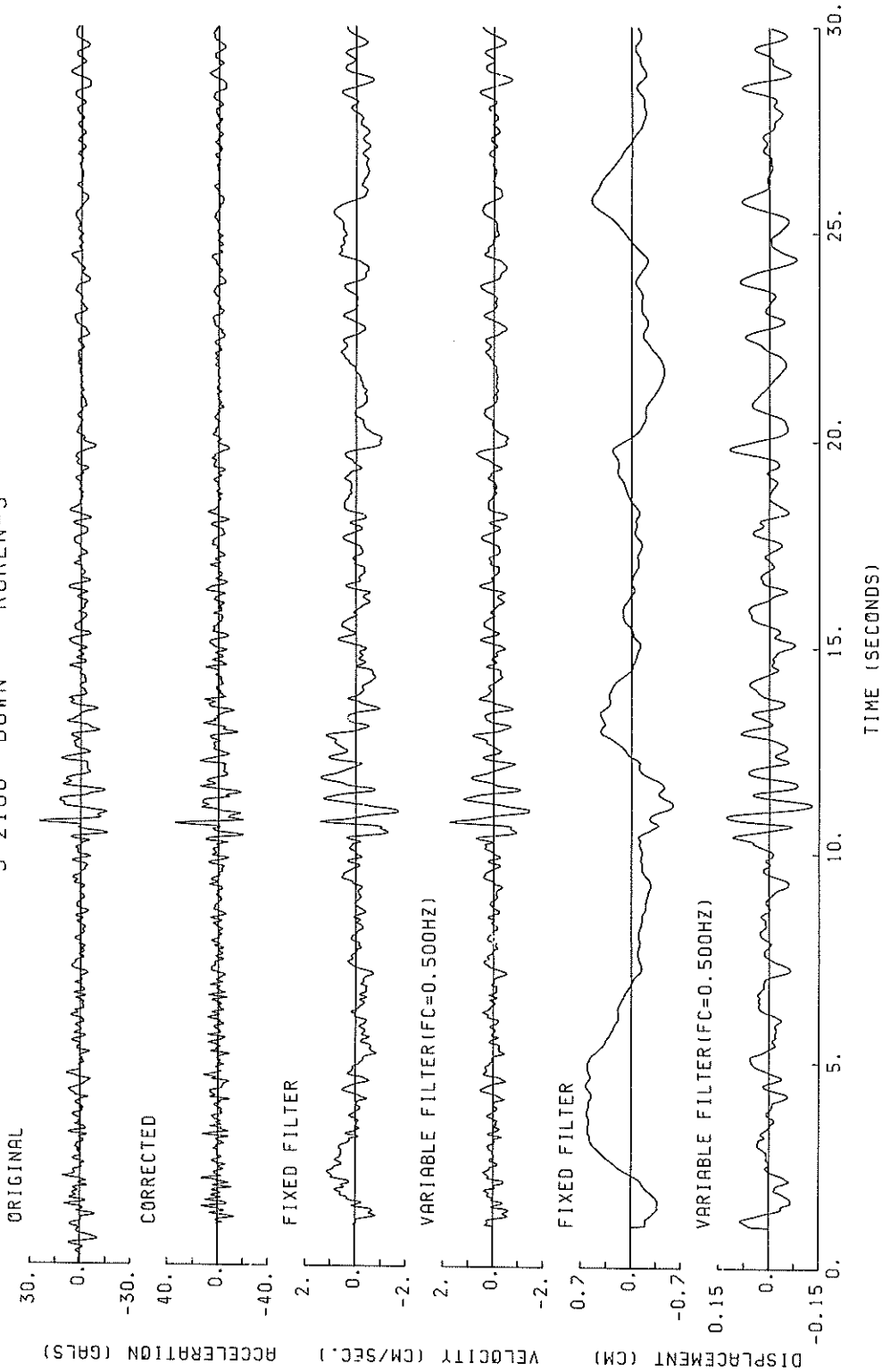

S-2106 DOWN KOKEN-S

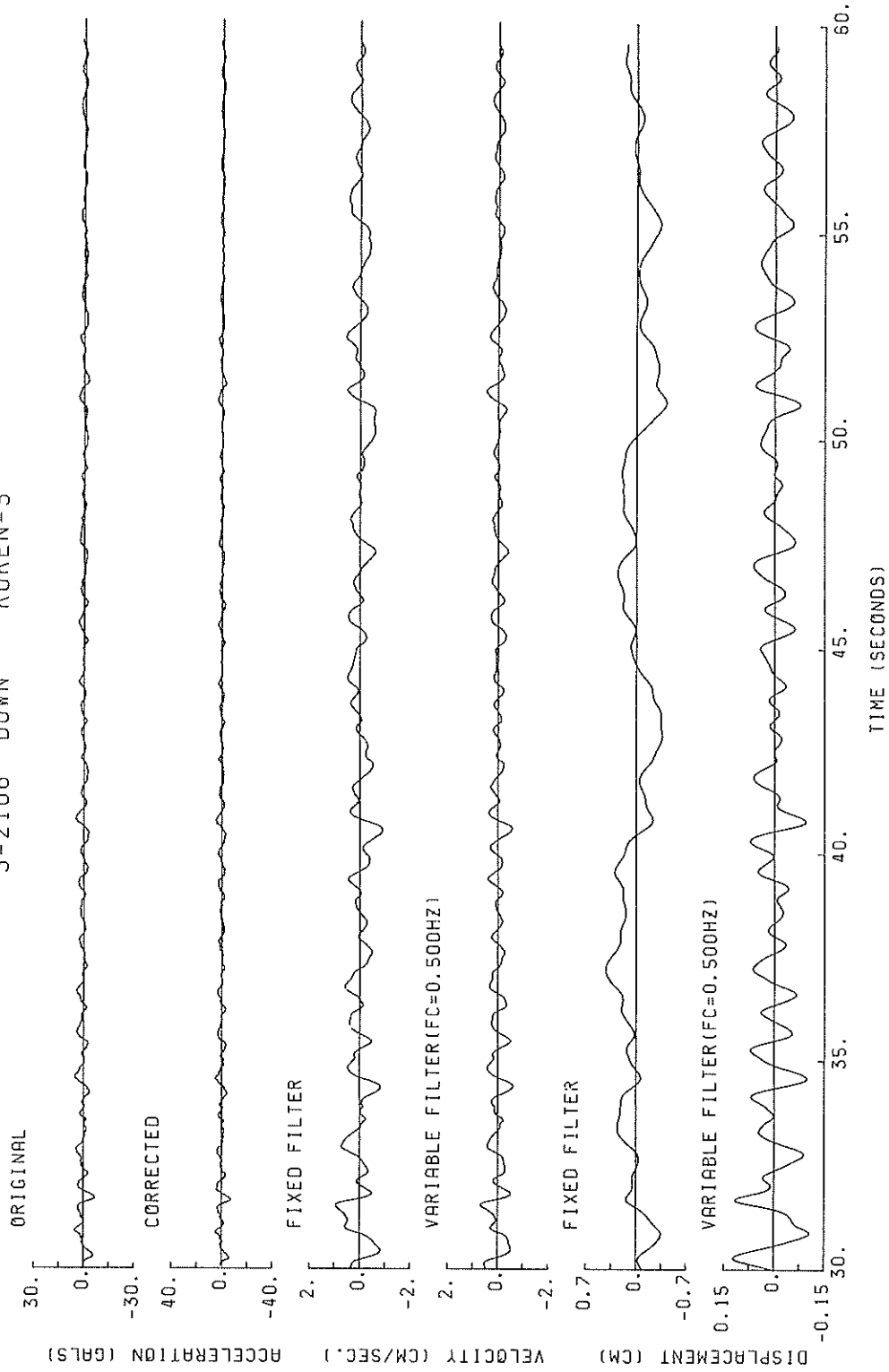

S-2106 NORTH KOKEN-S
 (1/FC=3.73 SEC.)

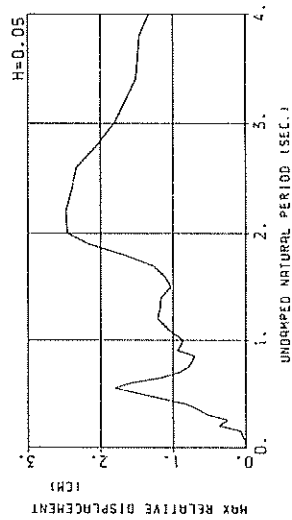
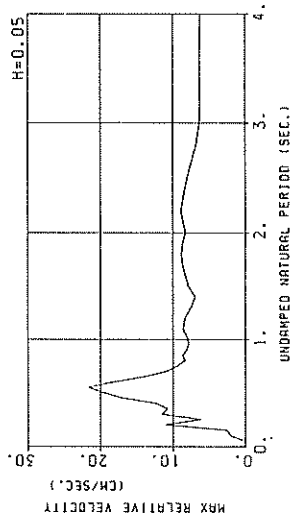
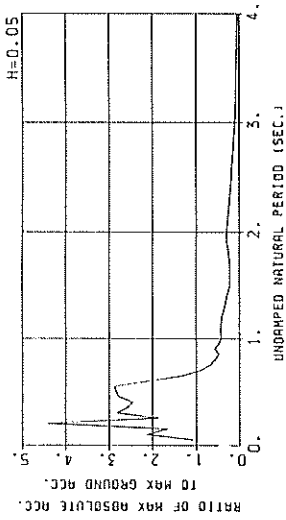

RESPONSE SPECTRA

S-2106 EAST KOKEN-S
 (1/FC=2.56 SEC.)

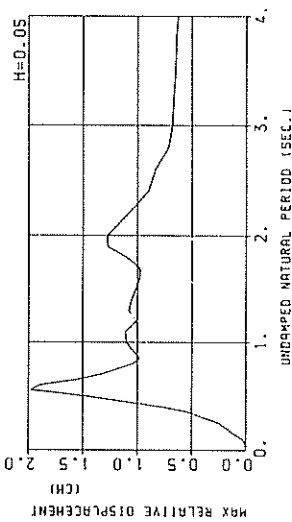
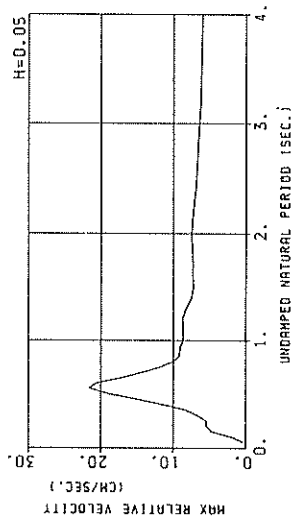
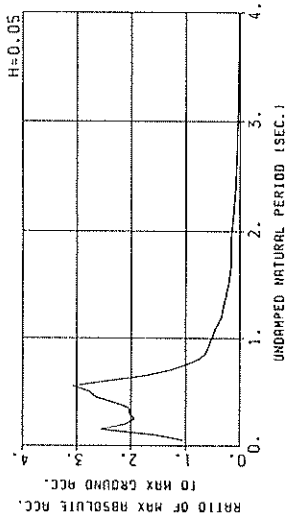

RESPONSE SPECTRA

S-2106 DOWN KOKEN-S
 $1/FC=2.00$ SEC.)

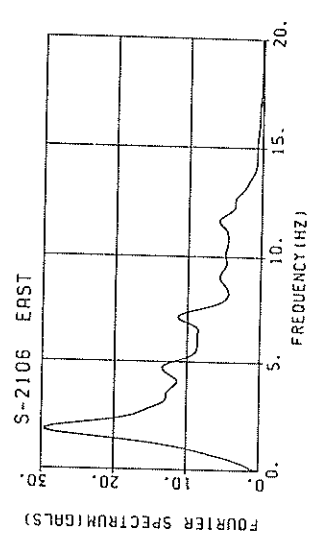
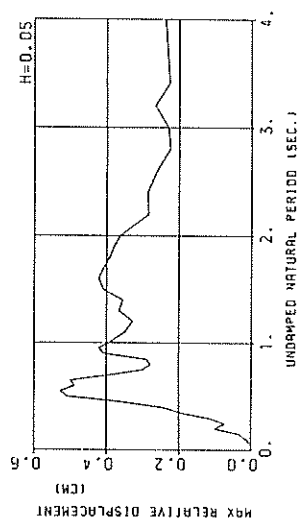
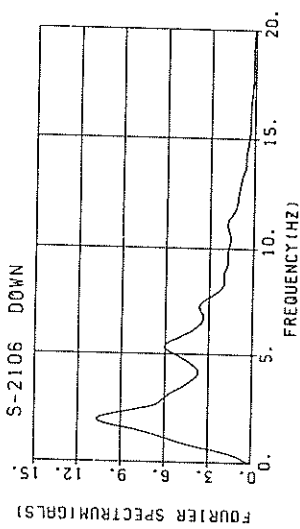
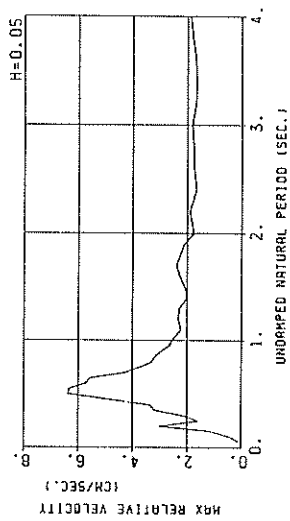
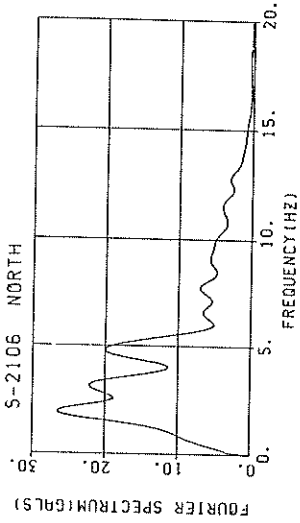
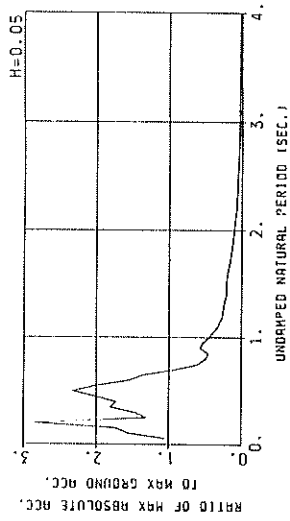

RESPONSE SPECTRA

FOURIER SPECTRA

RESPONSE SPECTRUM

RECORD = S-2106 COMPONENT = NORTH SIGNAL = GR. ACC. CORRECTION = STATION = KOKEN-S
 DATE AND TIME = 1987-12-17-11-08 SAMPRING INTERVAL = 0.0100(SEC) MAX.GROUND ACC. = 82.66 (GAL)
 TIME LENGTH = 58.99 (SEC) SKIPPED LENGTH = 0.00 (SEC)

PER	DAMPING = 0.			DAMPING = 0.025			DAMPING = 0.050			DAMPING = 0.100			DAMPING = 0.250		
	AA	RV	RD	AA	RV	RD	AA	RV	RD	AA	RV	RD	AA	RV	RD
0.05	101.7	0.31	0.006	87.8	0.20	0.006	87.3	0.19	0.006	87.5	0.18	0.006	87.3	0.17	0.005
0.10	358.9	5.31	0.091	220.2	2.78	0.056	176.0	2.04	0.04	134.0	1.58	0.034	101.3	0.86	0.025
0.15	284.3	6.33	0.162	152.7	3.32	0.087	137.9	2.84	0.078	134.5	2.58	0.075	124.0	0.95	0.025
0.20	525.0	16.63	0.550	443.4	13.39	0.450	364.4	10.93	0.369	254.6	7.75	0.255	150.6	4.03	0.139
0.25	237.7	9.29	0.376	172.2	6.52	0.271	154.2	6.15	0.243	146.2	6.06	0.226	124.8	4.00	0.184
0.30	614.8	29.04	1.402	308.1	14.81	0.703	233.2	11.58	0.530	188.9	8.09	0.423	132.5	5.52	0.271
0.35	702.5	38.99	2.180	333.0	17.30	0.721	212.9	10.72	0.657	183.5	9.50	0.558	128.0	6.83	0.356
0.40	492.1	18.44	1.184	214.6	12.75	0.871	202.7	12.41	0.818	174.4	11.28	0.693	128.2	7.87	0.472
0.45	314.5	21.82	1.613	266.7	19.30	1.367	229.7	17.26	1.171	178.5	14.09	0.898	130.1	8.58	0.590
0.50	502.5	40.21	3.182	298.9	24.00	1.895	234.9	19.63	1.482	187.7	15.03	1.156	123.9	8.53	0.672
0.55	522.2	45.49	4.001	301.3	27.65	2.306	237.8	21.67	1.812	163.4	15.19	1.219	108.4	9.07	0.686
0.60	268.9	26.56	2.452	213.2	21.00	1.944	177.1	18.57	1.733	132.8	14.91	1.173	88.0	9.35	0.640
0.65	198.8	20.88	2.127	121.8	14.81	1.299	109.8	14.11	1.167	92.6	12.56	0.960	72.2	9.05	0.632
0.70	91.6	13.47	1.137	78.7	11.80	0.976	74.1	10.90	0.911	67.1	10.11	0.804	62.0	8.46	0.605
0.75	117.5	13.89	1.674	60.4	10.12	0.860	55.9	9.44	0.790	49.9	8.41	0.687	53.6	7.86	0.578
0.80	195.0	24.74	3.161	52.2	8.65	0.846	46.1	8.32	0.740	43.4	7.94	0.665	46.9	7.36	0.557
0.85	119.0	16.24	2.179	42.6	9.18	0.778	39.0	8.60	0.707	37.4	7.94	0.644	41.4	6.97	0.536
0.90	143.4	20.40	2.941	63.8	8.49	1.308	46.4	8.10	0.707	31.6	7.78	0.608	36.8	6.70	0.515
0.95	119.2	18.28	2.725	57.6	9.35	1.315	39.7	7.82	0.900	27.5	7.66	0.594	32.8	6.70	0.493
1.00	67.2	11.54	1.702	46.0	7.95	1.163	34.2	7.93	0.861	25.8	7.69	0.643	29.4	6.69	0.467
1.10	62.3	10.89	1.910	40.1	9.00	1.227	35.1	8.55	1.066	28.1	7.86	0.827	23.4	6.58	0.490
1.20	50.2	10.81	1.833	40.2	8.95	1.465	33.5	8.33	1.217	25.4	7.50	0.896	19.8	6.36	0.549
1.30	65.5	13.80	2.805	34.0	8.67	1.456	27.7	7.48	1.181	20.1	6.42	0.848	18.9	6.04	0.607
1.40	31.7	8.13	1.576	26.7	7.42	1.323	23.8	6.87	1.165	19.6	6.59	0.940	17.8	6.50	0.654
1.50	49.1	11.38	2.797	21.1	8.19	1.198	18.2	7.82	1.029	16.9	7.31	0.921	16.6	6.56	0.693
1.60	35.1	8.82	2.274	19.8	8.57	1.282	17.5	8.29	1.119	15.2	7.76	0.952	15.3	6.77	0.762
1.70	32.6	9.39	2.385	20.6	9.00	1.505	17.6	8.85	1.278	14.9	8.05	1.029	14.5	6.93	0.829
1.80	62.8	17.97	5.154	23.4	9.24	1.916	20.5	8.81	1.670	16.7	8.16	1.326	14.1	7.00	0.892
1.90	39.1	12.09	3.578	28.7	9.59	2.623	23.9	8.54	2.171	17.8	8.07	1.567	13.8	7.00	0.946
2.00	46.4	15.38	4.703	30.5	9.82	3.086	24.4	8.27	2.465	16.9	7.84	1.678	13.4	6.93	0.981
2.20	39.2	14.83	4.810	25.6	10.84	3.139	20.4	8.88	2.478	15.4	7.13	1.804	11.9	6.65	0.973
2.40	52.0	12.72	4.670	20.0	9.21	2.910	16.6	8.31	2.599	13.1	7.16	1.856	11.0	6.28	1.112
2.60	17.5	8.74	2.994	15.4	8.16	2.631	13.8	7.52	2.328	11.5	7.00	1.872	10.1	6.10	1.210
2.80	12.4	6.93	2.467	11.4	6.81	2.255	10.4	6.77	2.048	9.4	6.62	1.733	9.2	6.10	1.249
3.00	12.1	6.44	2.759	8.6	6.36	1.956	8.1	6.30	1.809	7.8	6.26	1.637	8.3	5.97	1.246
3.20	11.8	6.47	3.063	6.7	6.32	1.744	6.5	6.23	1.665	6.5	6.03	1.530	7.6	5.81	1.217
3.40	8.7	6.47	2.546	5.7	6.36	1.676	5.3	6.26	1.509	5.4	6.06	1.407	6.9	5.66	1.172
3.60	6.50	2.134	4.6	5.4	6.37	1.762	4.6	6.26	1.485	4.5	6.06	1.274	6.3	5.57	1.120
3.80	5.2	6.43	1.909	4.6	6.32	1.667	4.1	6.22	1.464	3.8	6.04	1.249	5.8	5.59	1.065
4.00	4.5	6.30	1.809	3.6	6.22	1.455	3.5	6.15	1.529	3.5	6.00	1.237	5.4	5.51	1.073

PER = PERIOD (SEC) AA = ABSOLUTE ACC. (GAL) RV = RELATIVE VELOCITY (CM/SEC) RD = RELATIVE DISPLACEMENT (CM)

RESPONSE SPECTRUM

RECORD = S-2106 COMPONENT = EAST SIGNAL = GR. ACC. CORRECTION = STATION = KOKEN-W-
 DATE AND TIME = 1987-12-17-11-08 SAMPRING INTERVAL = 0.0100(SEC) MAX. GROUND ACC. = 84.88 (GAL)
 TIME LENGTH = 58.99 (SEC) SKIPPED LENGTH = 0.00 (SEC)

PER	DAMPING = 0.			DAMPING = 0.025			DAMPING = 0.050			DAMPING = 0.100			DAMPING = 0.250		
	AA	RV	RD	AA	RV	RD	AA	RV	RD	AA	RV	RD	AA	RV	RD
0.05	90.0	0.32	0.006	88.0	0.20	0.006	87.6	0.19	0.006	87.7	0.18	0.006	88.0	0.18	0.006
0.10	406.2	6.24	0.103	176.5	2.52	0.045	151.9	1.85	0.033	119.3	1.26	0.030	106.9	0.77	0.026
0.15	358.3	8.16	0.203	259.8	5.67	0.147	216.9	4.70	0.122	152.8	3.25	0.085	116.5	1.61	0.064
0.20	477.8	14.91	0.484	236.1	7.44	0.239	178.8	5.36	0.179	156.2	4.14	0.156	120.2	2.56	0.115
0.25	421.3	16.84	0.667	176.2	6.57	0.279	163.9	5.47	0.257	149.8	4.25	0.234	122.8	2.93	0.181
0.30	242.8	11.33	0.554	178.0	8.20	0.406	172.1	6.57	0.392	157.6	5.44	0.354	125.0	4.05	0.261
0.35	375.9	20.84	1.169	199.6	10.45	0.618	173.1	8.28	0.534	155.1	6.79	0.474	121.0	5.08	0.344
0.40	283.2	17.96	1.148	210.3	12.69	0.850	195.3	11.31	0.788	167.4	8.87	0.668	122.0	5.95	0.451
0.45	340.1	23.08	1.745	268.0	17.75	1.355	225.1	14.90	1.148	186.5	11.51	0.939	127.2	6.67	0.580
0.50	508.5	59.98	3.207	284.5	23.00	1.797	234.6	18.85	1.481	182.6	13.98	1.133	121.7	8.24	0.671
0.55	688.7	53.12	4.664	332.5	28.76	2.545	259.9	21.70	1.982	173.5	14.60	1.301	108.3	9.28	0.722
0.60	638.0	60.84	5.818	263.1	26.78	2.397	208.1	20.63	1.887	145.3	14.69	1.290	92.5	9.72	0.753
0.65	222.2	24.36	2.378	172.9	20.19	1.845	146.4	17.13	1.557	117.7	13.65	1.225	80.1	9.73	0.765
0.70	137.6	17.59	1.708	118.9	15.51	1.473	107.6	14.18	1.327	94.3	12.30	1.134	70.3	9.45	0.753
0.75	137.2	16.42	1.955	90.4	12.52	1.287	83.7	11.77	1.185	74.7	11.01	1.033	61.1	9.00	0.750
0.80	135.3	16.84	2.161	65.9	10.11	1.067	64.3	10.02	1.036	61.5	9.84	0.959	54.8	8.54	0.760
0.85	113.2	15.35	2.072	56.4	9.47	1.029	54.1	9.22	0.979	53.9	9.05	0.943	50.0	8.08	0.766
0.90	114.5	16.83	2.350	51.4	9.65	1.052	50.2	9.11	1.018	48.9	8.47	0.955	46.0	7.82	0.769
0.95	100.3	15.42	2.292	48.6	9.46	1.107	47.1	8.95	1.041	45.0	8.01	0.977	42.4	7.17	0.772
1.00	75.0	11.77	1.901	46.0	9.20	1.161	44.0	8.65	1.099	41.5	7.85	0.992	39.0	6.83	0.768
1.10	66.7	11.78	2.046	39.3	9.01	1.199	36.9	8.65	1.112	34.1	8.03	0.977	33.0	6.78	0.742
1.20	41.2	10.17	1.503	29.7	9.39	1.079	28.1	8.76	1.005	26.6	7.91	0.901	27.8	6.64	0.724
1.30	50.8	11.12	2.175	27.1	8.72	1.156	25.8	8.29	1.081	24.5	7.56	0.945	25.6	6.40	0.761
1.40	44.2	10.54	2.196	22.2	7.82	1.098	21.7	7.46	1.053	21.4	7.06	0.967	23.5	6.11	0.779
1.50	23.7	7.57	1.354	18.5	7.41	1.046	18.2	7.22	1.013	18.5	6.85	0.947	21.4	5.91	0.784
1.60	26.1	7.79	1.696	15.7	7.53	1.011	15.5	7.31	0.977	16.0	6.95	0.920	19.5	6.06	0.777
1.70	17.6	7.59	1.290	14.8	7.45	1.085	13.4	7.30	0.976	13.9	7.01	0.889	17.8	6.19	0.764
1.80	18.7	7.42	1.532	15.6	7.59	1.280	13.5	7.30	1.099	12.2	7.05	0.859	16.2	6.28	0.745
1.90	36.5	11.20	3.340	17.2	7.59	1.571	14.1	7.42	1.274	10.7	7.11	0.892	14.9	6.34	0.721
2.00	27.0	9.47	2.736	16.0	7.76	1.613	12.7	7.51	1.278	10.2	7.13	0.949	13.6	6.38	0.694
2.20	17.6	7.42	2.158	10.1	7.32	1.233	9.1	7.21	1.086	8.1	6.98	0.900	11.5	6.39	0.635
2.40	7.6	6.84	1.105	6.9	6.87	0.999	6.3	6.86	0.897	5.4	6.77	0.723	9.9	6.35	0.579
2.60	6.1	6.86	1.040	5.4	6.79	0.924	5.1	6.73	0.834	4.6	6.63	0.697	8.7	6.30	0.531
2.80	4.4	6.71	0.872	4.0	6.64	0.786	3.7	6.59	0.717	3.7	6.50	0.610	7.7	6.23	0.501
3.00	6.1	6.39	1.398	3.7	6.40	0.839	3.2	6.39	0.680	3.4	6.35	0.602	7.0	6.17	0.496
3.20	3.20	6.17	0.772	2.7	6.21	0.700	2.8	6.23	0.670	3.1	6.23	0.614	6.4	6.10	0.507
3.40	2.3	6.09	0.686	2.3	6.12	0.672	2.4	6.13	0.654	2.8	6.14	0.612	5.8	6.05	0.514
3.60	2.1	6.08	0.685	2.1	6.08	0.666	2.2	6.08	0.647	2.5	6.08	0.608	5.4	6.01	0.519
3.80	1.9	6.06	0.691	1.9	6.05	0.664	2.0	6.04	0.641	2.3	6.03	0.602	5.1	5.97	0.523
4.00	1.7	6.01	0.678	1.6	6.00	0.650	1.7	5.99	0.626	2.2	5.98	0.590	4.7	5.93	0.525

PER = PERIOD (SEC) AA = ABSOLUTE ACC. (GAL) RV = RELATIVE VELOCITY (CM/SEC) RD = RELATIVE DISPLACEMENT (CM)

RESPONSE SPECTRUM

RECORD = S-2106
 DATE AND TIME = 1987-12-17-11-08
 TIME LENGTH = 58.99 (SEC)

COMPONENT = DOWN
 SIGNAL = GR. ACC.
 SAMPRING INTERVAL = 0.0100(SEC)
 SKIPPED LENGTH = 0.00 (SEC)

STATION = KOKEN-S
 MAX.GROUND ACC. = 34.81 (GAL)

PER	DAMPING = 0.			DAMPING = 0.025			DAMPING = 0.050			DAMPING = 0.100			DAMPING = 0.250		
	AA	RV	RD	AA	RV	RD	AA	RV	RD	AA	RV	RD	AA	RV	RD
0.05	40.2	0.13	0.003	35.9	0.07	0.002	36.0	0.07	0.002	36.2	0.07	0.002	36.4	0.07	0.002
0.10	136.6	2.13	0.035	61.2	0.57	0.015	54.1	0.43	0.014	48.2	0.39	0.012	43.4	0.36	0.011
0.15	223.5	5.17	0.127	82.3	1.21	0.036	60.1	1.13	0.034	59.2	1.13	0.033	47.4	0.90	0.026
0.20	154.9	4.87	0.157	118.5	3.23	0.120	99.5	3.02	0.101	73.7	2.26	0.073	45.9	1.35	0.042
0.25	118.2	4.64	0.187	56.3	1.98	0.089	45.5	1.57	0.072	41.2	1.48	0.064	34.8	1.35	0.050
0.30	156.3	7.45	0.356	58.9	2.59	0.134	50.8	2.07	0.115	44.2	1.92	0.099	32.5	1.55	0.068
0.35	99.6	5.39	0.309	75.1	3.75	0.233	63.0	3.19	0.195	49.9	2.61	0.153	34.3	1.79	0.095
0.40	111.3	7.03	0.451	66.6	3.68	0.270	60.1	3.37	0.242	48.4	3.70	0.194	33.9	1.90	0.125
0.45	93.2	6.29	0.478	83.6	5.49	0.428	70.5	4.96	0.360	52.4	3.70	0.265	33.3	2.02	0.156
0.50	245.5	19.59	1.555	113.6	8.99	0.720	80.9	6.39	0.510	58.0	4.51	0.360	32.6	2.18	0.183
0.55	155.0	13.40	1.187	91.8	8.19	0.702	69.4	6.34	0.529	52.4	4.49	0.391	30.2	2.45	0.204
0.60	87.7	8.45	0.799	65.5	6.46	0.597	53.9	5.73	0.489	42.1	4.58	0.374	27.1	2.60	0.216
0.65	229.7	23.69	2.459	61.4	7.14	0.657	46.9	5.54	0.500	35.4	4.21	0.370	23.8	2.57	0.216
0.70	86.6	9.62	1.075	37.4	4.89	0.463	32.5	4.31	0.401	26.7	3.48	0.323	20.1	2.48	0.207
0.75	35.5	4.15	0.502	24.4	4.04	0.348	21.2	3.77	0.300	18.7	3.31	0.259	16.7	2.52	0.194
0.80	45.7	6.07	0.740	23.4	3.17	0.379	17.2	3.29	0.277	14.0	3.13	0.220	12.0	2.53	0.182
0.85	71.8	9.69	1.313	21.5	3.42	0.392	15.9	3.17	0.290	13.4	2.94	0.250	10.0	2.49	0.173
0.90	47.5	6.96	0.974	27.4	3.91	0.562	20.0	2.91	0.408	13.4	2.73	0.270	10.5	2.43	0.167
0.95	77.3	11.84	1.767	30.2	4.44	0.688	18.5	2.64	0.422	12.5	2.46	0.279	9.2	2.36	0.162
1.00	47.6	7.74	1.206	21.0	3.37	0.532	15.6	2.55	0.394	10.7	2.27	0.266	8.2	2.30	0.158
1.10	63.4	10.98	1.944	14.9	2.71	0.457	11.5	2.22	0.350	8.1	2.17	0.242	6.8	2.21	0.150
1.20	20.7	4.24	0.755	11.4	2.65	0.415	9.0	2.32	0.327	7.3	2.23	0.257	5.8	2.15	0.161
1.30	26.1	5.38	1.116	11.7	2.53	0.500	8.6	2.29	0.365	6.3	2.16	0.250	5.1	2.11	0.170
1.40	22.6	5.07	1.124	9.5	2.32	0.469	7.2	1.98	0.355	5.7	1.98	0.274	4.5	2.07	0.172
1.50	19.2	4.71	1.094	9.8	2.50	0.558	7.2	2.08	0.409	5.2	2.05	0.287	4.1	2.05	0.167
1.60	26.8	6.85	1.737	9.3	2.51	0.600	6.5	2.27	0.422	4.5	2.16	0.288	3.7	2.03	0.154
1.70	10.8	3.13	0.790	6.6	2.27	0.483	5.6	2.39	0.408	4.0	2.19	0.288	3.4	2.01	0.167
1.80	15.2	4.60	1.251	4.7	2.44	0.525	4.8	2.24	0.390	3.5	2.08	0.280	3.3	1.97	0.178
1.90	10.7	3.44	0.981	4.7	2.44	0.435	4.2	2.10	0.379	3.0	1.88	0.274	3.1	1.93	0.185
2.00	6.0	2.35	0.609	4.5	1.84	0.455	3.6	1.76	0.363	2.8	1.76	0.268	3.0	1.90	0.189
2.20	3.5	2.42	0.434	2.5	2.07	0.299	2.4	1.90	0.284	2.2	1.80	0.250	2.8	1.84	0.190
2.40	4.3	2.06	0.633	2.4	1.80	0.343	2.0	1.66	0.286	1.9	1.70	0.233	2.5	1.80	0.184
2.60	4.5	2.29	0.777	1.7	1.91	0.291	1.6	1.75	0.261	1.6	1.65	0.226	2.3	1.78	0.185
2.80	1.8	1.99	0.559	1.3	1.84	0.258	1.2	1.77	0.224	1.2	1.73	0.199	2.1	1.77	0.183
3.00	1.3	1.98	0.290	1.0	1.88	0.230	1.1	1.81	0.200	1.1	1.76	0.208	1.9	1.76	0.181
3.20	2.4	1.56	0.619	1.4	1.63	0.358	1.1	1.67	0.266	1.0	1.71	0.212	1.7	1.76	0.184
3.40	1.3	1.86	0.382	0.9	1.73	0.266	0.8	1.65	0.227	0.9	1.69	0.217	1.6	1.76	0.190
3.60	0.9	1.79	0.295	0.7	1.70	0.236	0.7	1.69	0.231	0.8	1.72	0.221	1.5	1.76	0.195
3.80	0.8	1.90	0.298	0.7	1.84	0.239	0.7	1.81	0.234	0.7	1.78	0.224	1.4	1.77	0.199
4.00	0.8	2.03	0.319	0.6	1.94	0.243	0.6	1.88	0.237	0.7	1.81	0.228	1.4	1.77	0.203

PER = PERIOD (SEC) AA = ABSOLUTE ACC. (GAL) RV = RELATIVE VELOCITY (CH/SEC) RD = RELATIVE DISPLACEMENT (CH)

S-2106 KOKEN-S

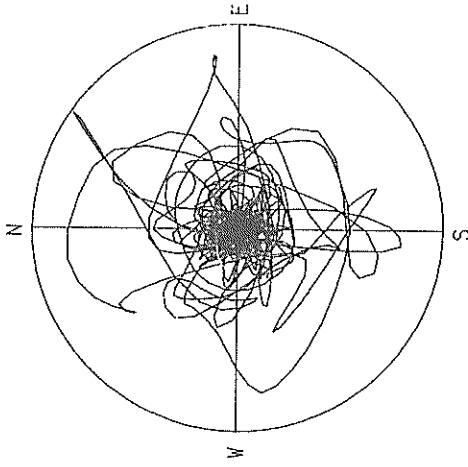

ACCELERATION
R=100.0GAL
MAX=98.3 GAL

S-2106 KOKEN-S

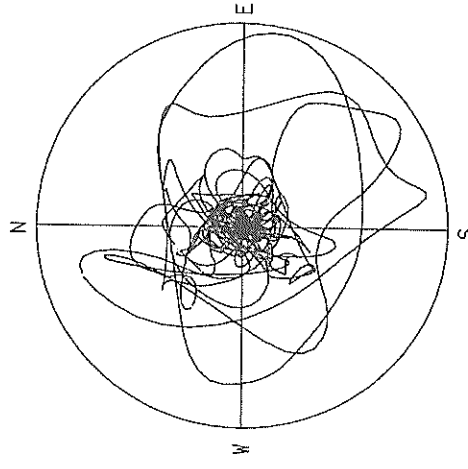

VELOCITY
R=6.0 CM/SEC.
MAX=5.8 CM/SEC.

S-2106 KOKEN-S

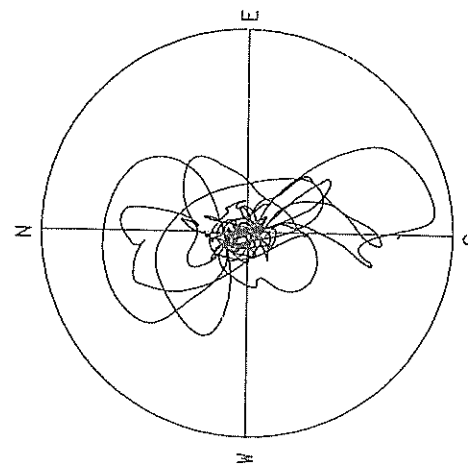

DISPLACEMENT
R=1.00 CM
MAX=0.92 CM

RECORD NUMBER
STATION

S-2107 CHIBA-S

EARTHQUAKE DATA

DATA AND TIME *****
11: 8 DEC.17,1987 *****
LOCATION OF HYPOCENTER *****
EPCENTRAL REGION *****
LATITUDE *****
LONGITUDE *****
DEPTH *****
MAGNITUDE *****

CHIBA-KEN-TOHO-OKI *****
35°22' N *****
140°30' E *****
58KM *****
6.7 *****

PEAK VALUES OF COMPONENTS

N S E W U D HORIZONTAL*

PARAMETER OF THE VARIABLE FILTER

FC (HZ) 0.189 0.158 0.226

MAXIMUM ACCELERATION (GAL)

ORIGINAL 160.9 170.9 57.4 185.8
CORRECTED 300.7 262.7 113.4 309.0

MAXIMUM VELOCITY (CM/SEC)

FIXED FILTER 13.25 19.40 4.12 19.62
VARIABLE FILTER 13.38 17.90 3.63 18.24

MAXIMUM DISPLACEMENT (CM)

FIXED FILTER 2.343 3.911 2.031 4.205
VARIABLE FILTER 1.770 2.862 0.688 3.224

* RESULTANT OF HORIZONTAL COMPONENTS

S-2107 CHIBRA-S

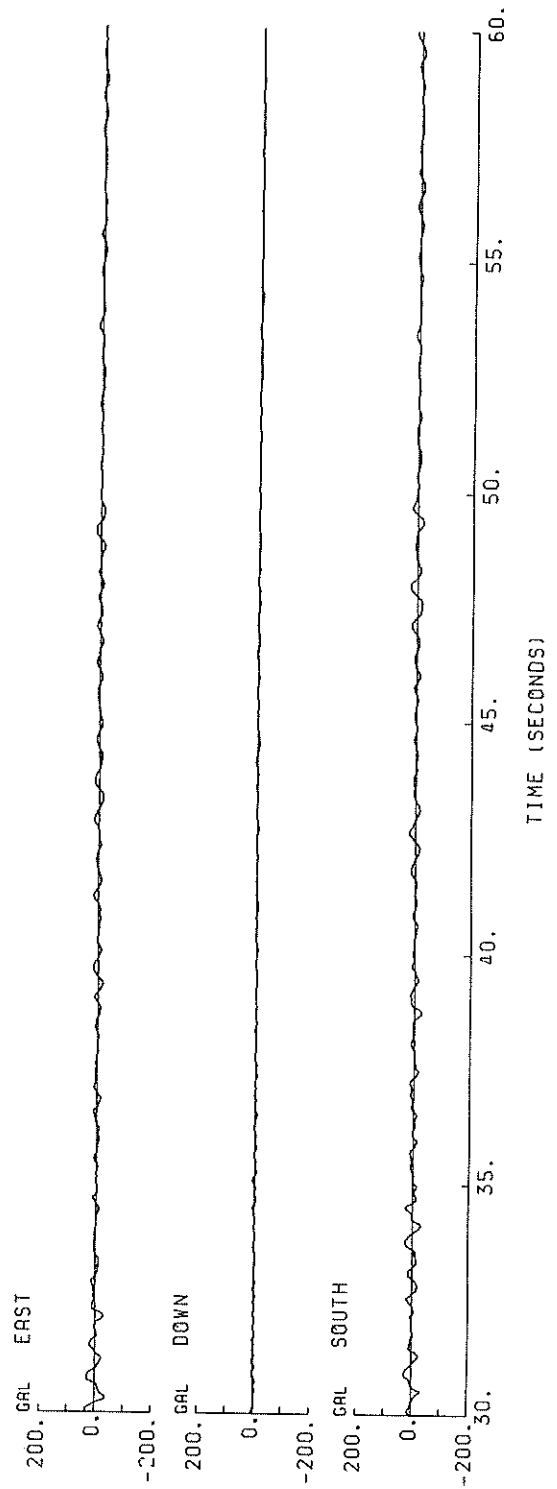
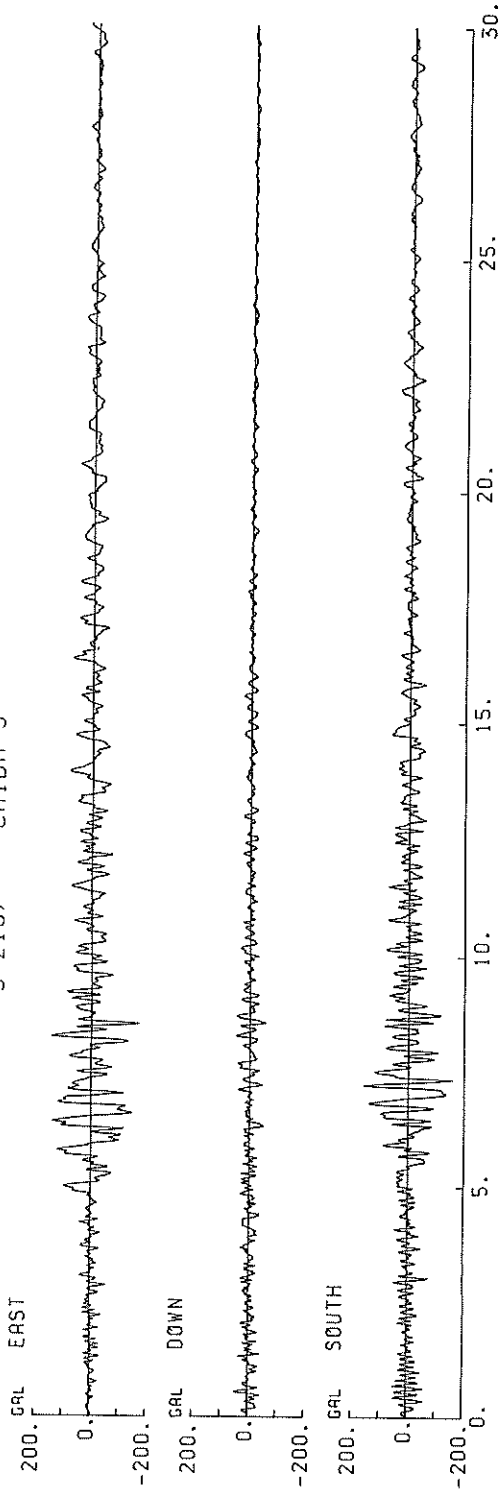

S-2107 SOUTH CHIBA-S

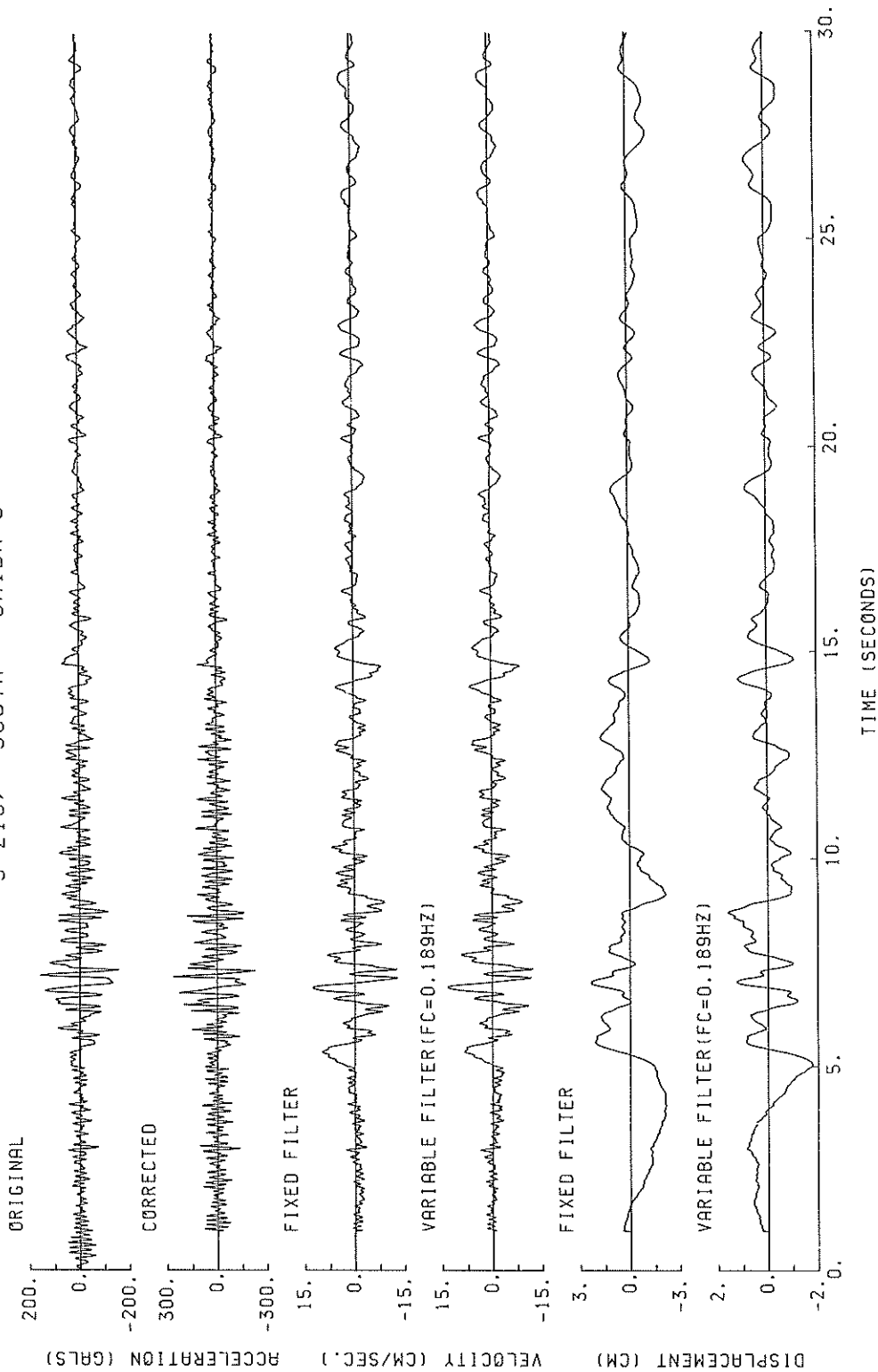

S-2107 SOUTH CHIBA-S

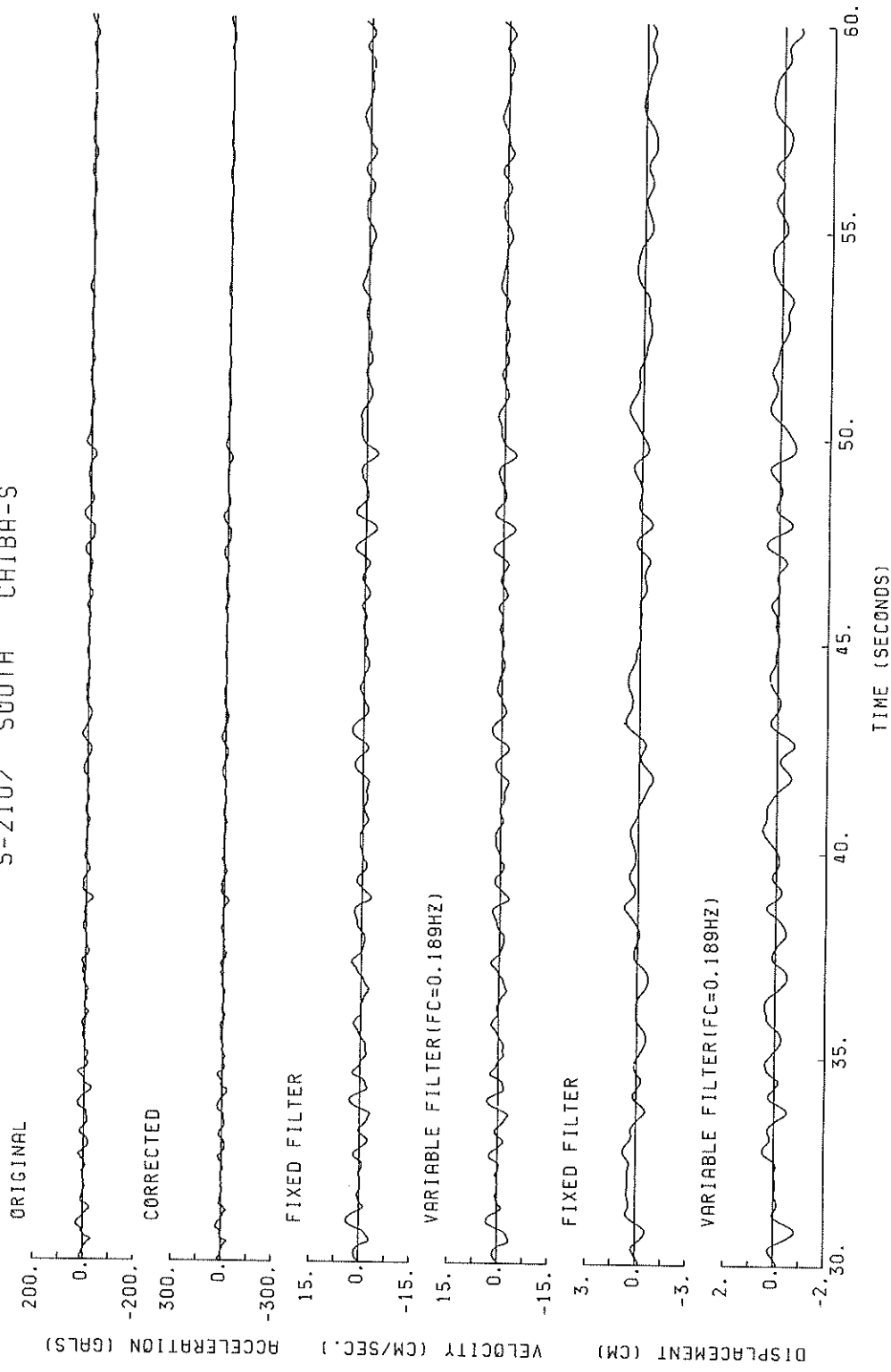

S-2107 EAST CHIBA-S

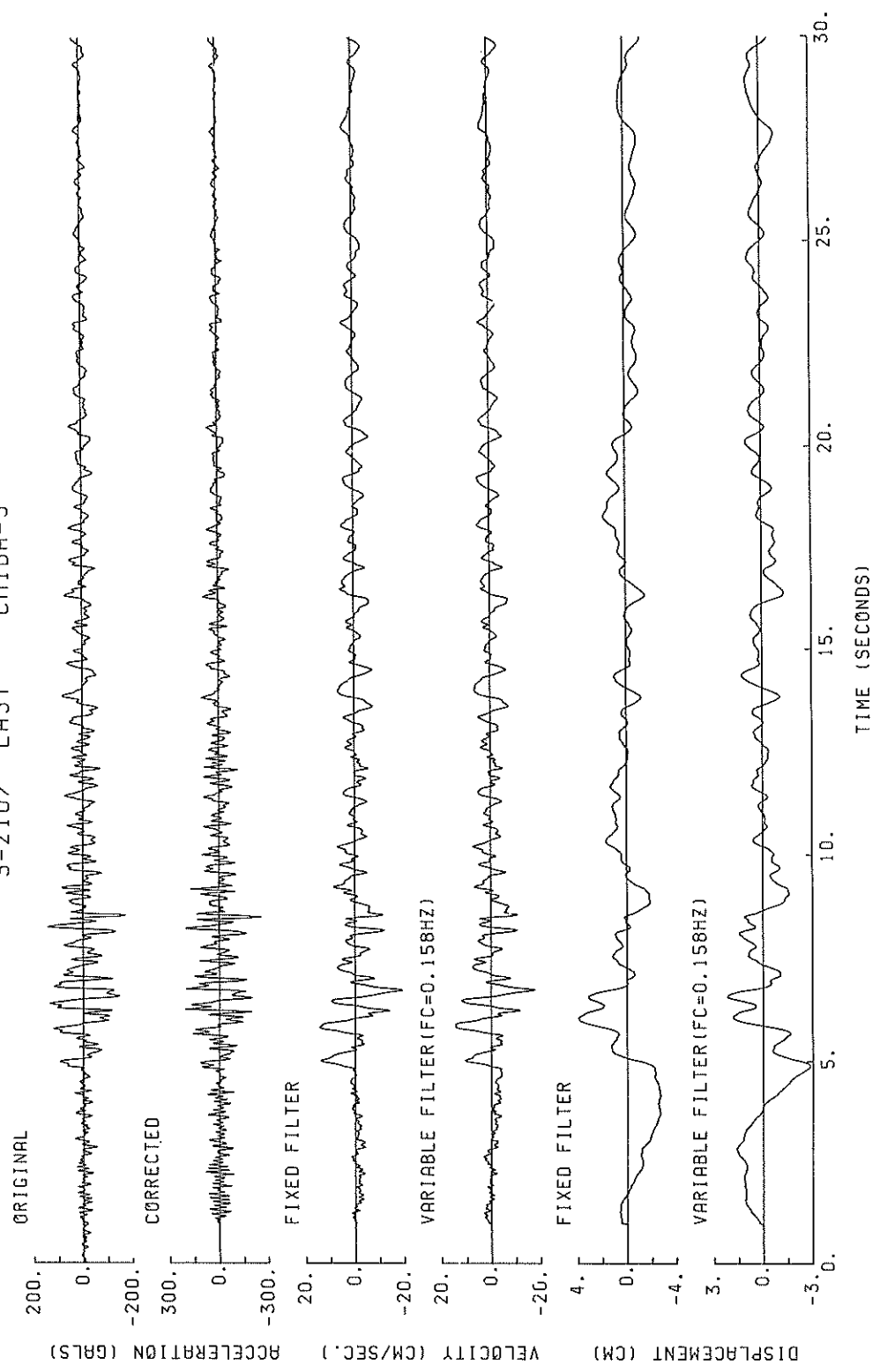

S-2107 EAST CHIBA-S

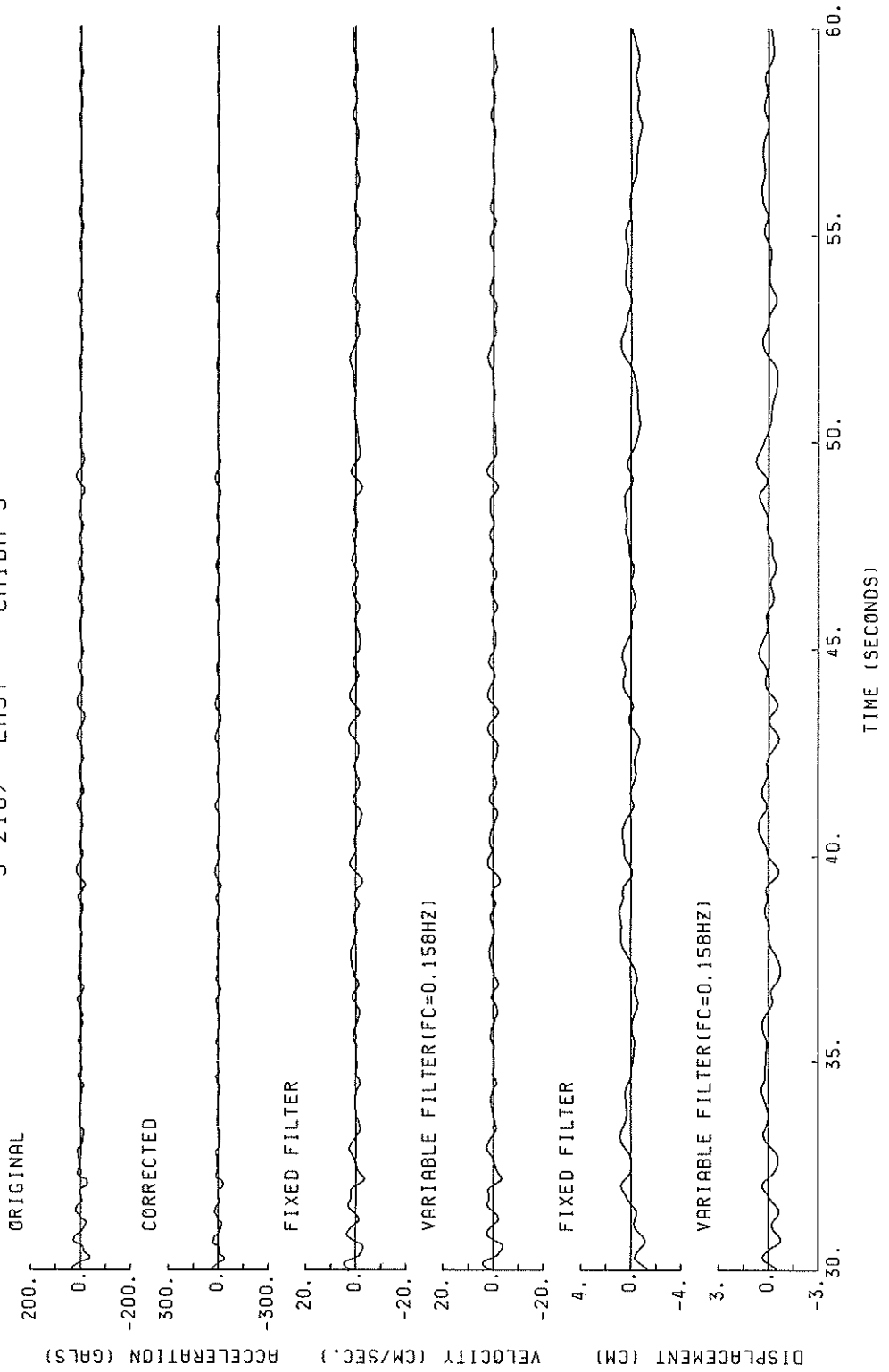

S-2107 DOWN CHIBA-S

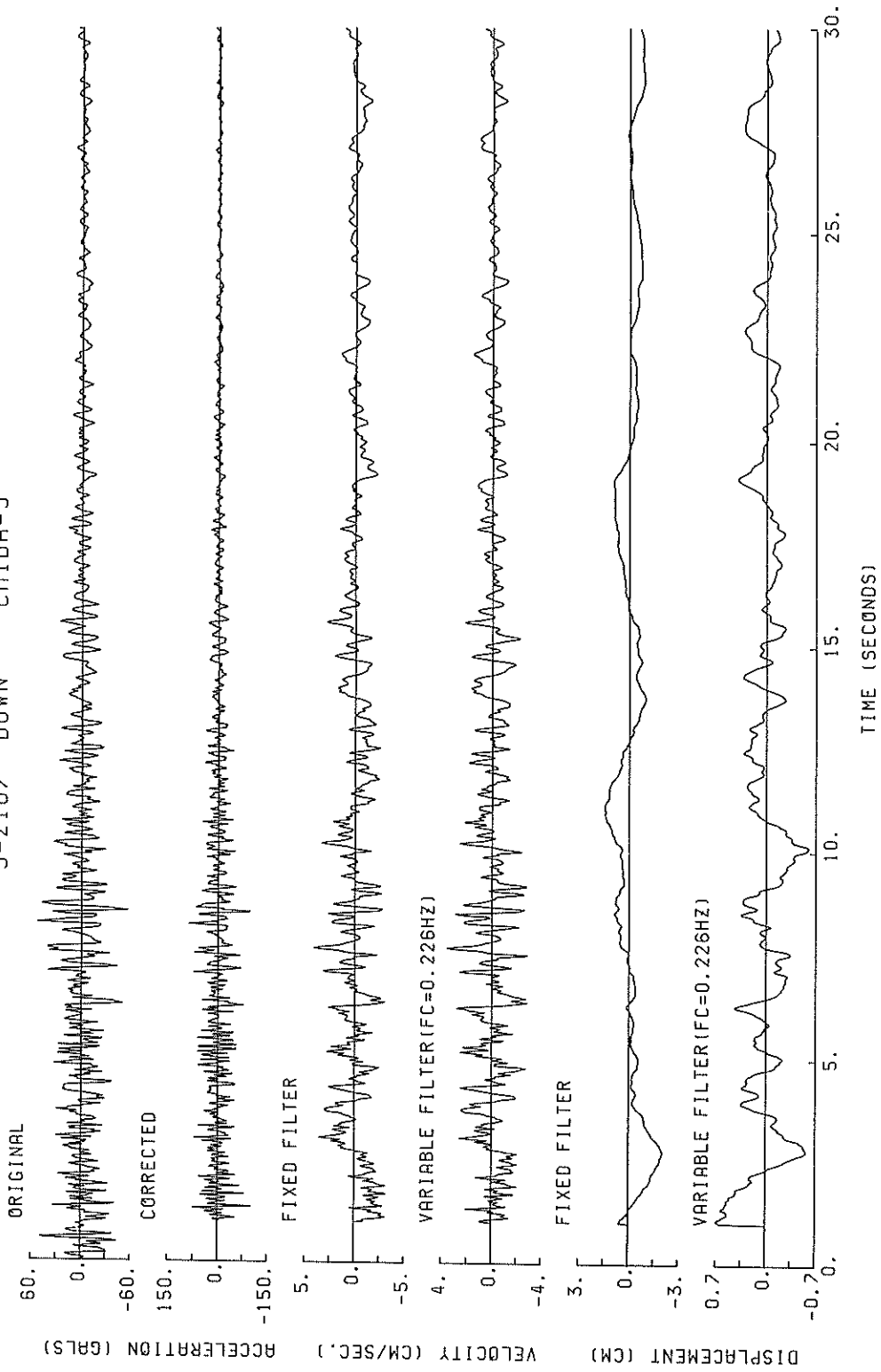

S-2107 DOWN CHIBA-S

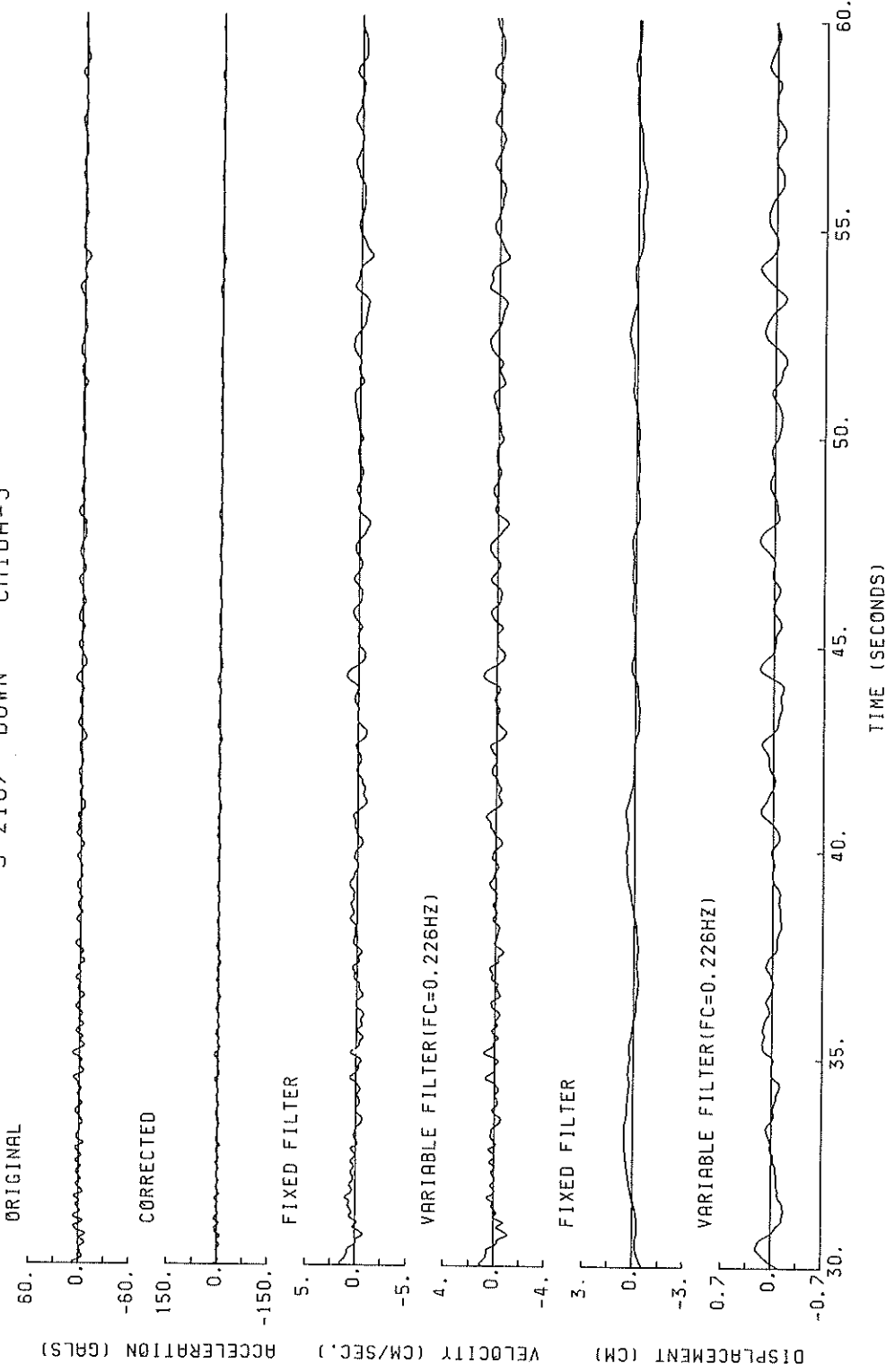

S-2107 SOUTH CHIBA-S
(1/FC=5.29 SEC.)

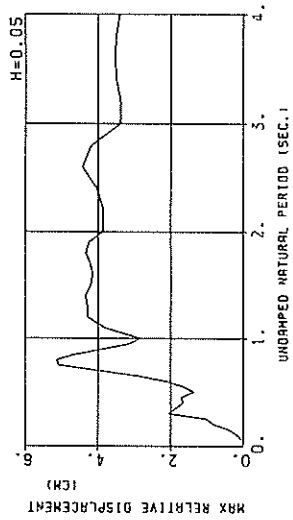
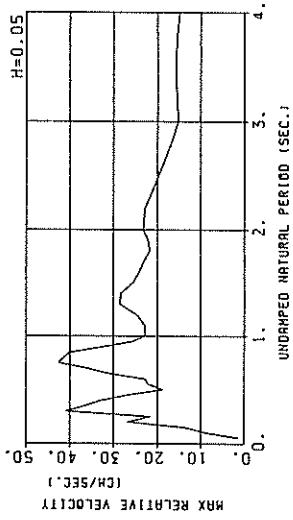
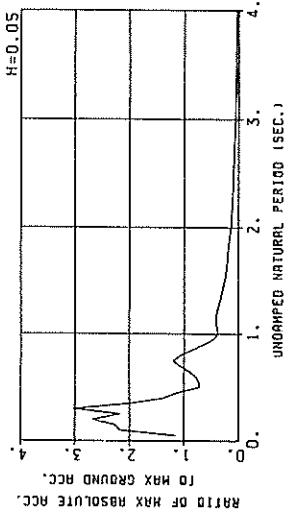

RESPONSE SPECTRA

S-2107 EAST CHIBA-S
(1/FC=6.32 SEC.)

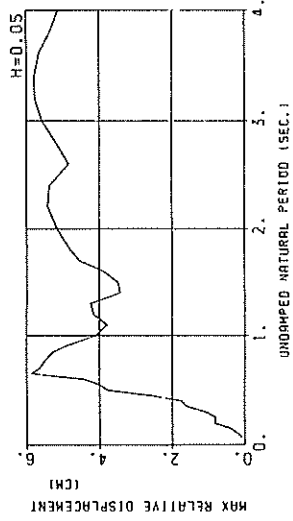
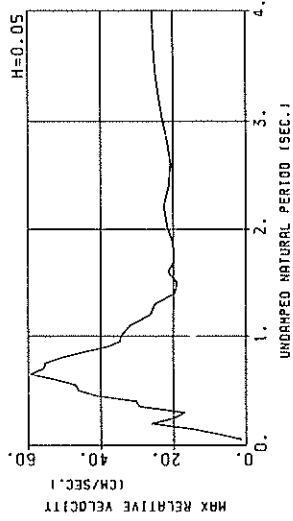
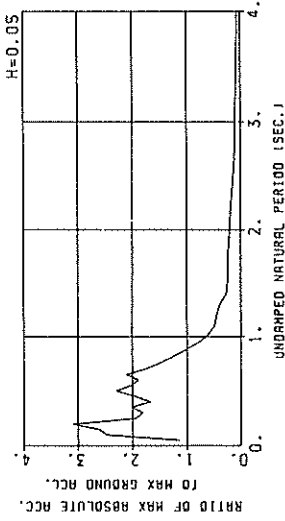

RESPONSE SPECTRA

S-2107 DOWN CHIBA-S
(1/FC=4.42 SEC.)

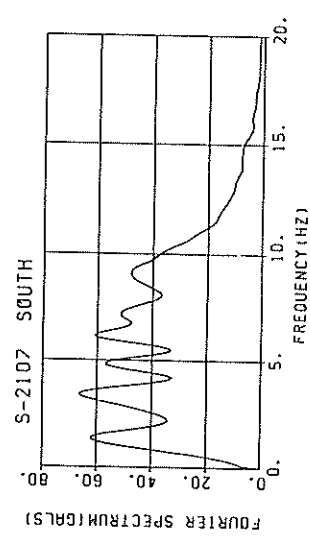
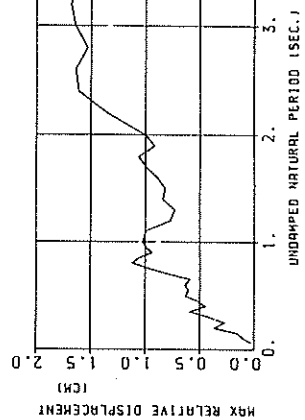
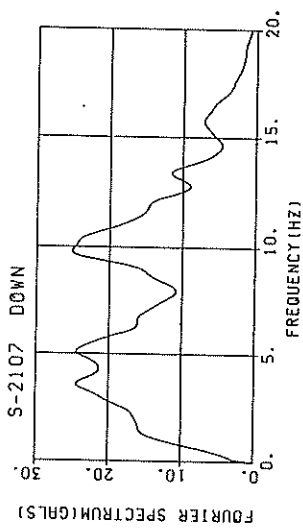
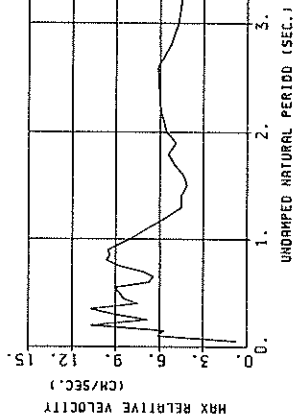
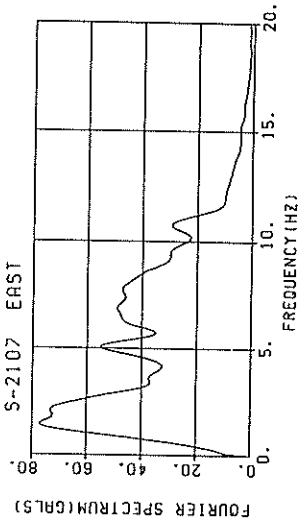
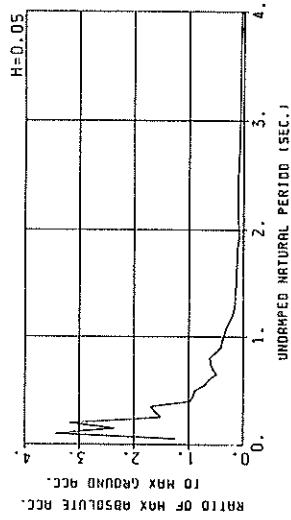

RESPONSE SPECTRA

FOURIER SPECTRA

RESPONSE SPECTRUM

RECORD = S-2107 COMPONENT = SOUTH SIGNAL = GR. ACC. CORRECTION = STATION = CHIBA-S
 DATE AND TIME = 1988-12-17-11-08 SAMPRING INTERVAL = 0.0100(SEC) MAX.GROUND ACC. = 300.66 (GAL)
 TIME LENGTH = 88.99 (SEC) SKIPPED LENGTH = 0.00 (SEC)

PER AA RV RD AA RV RD AA RV RD AA RV RD AA RV RD AA RV RD

DAMPING = 0. DAMPING = 0.025 DAMPING = 0.050 DAMPING = 0.100 DAMPING = 0.250

0.05	536.6	3.03	0.034	344.2	1.06	0.022	347.5	0.99	0.022	346.0	0.98	0.022	338.7	0.92	0.021
0.10	3114.6	49.01	0.789	819.5	11.26	0.207	855.9	8.72	0.166	492.6	6.15	0.123	427.8	4.04	0.103
0.15	1489.5	35.00	0.849	878.6	18.76	0.497	684.7	13.77	0.393	570.0	11.72	0.321	399.8	7.21	0.209
0.20	2912.0	62.38	2.951	1006.1	31.32	1.023	805.8	26.74	0.820	604.2	19.98	0.608	407.9	11.42	0.378
0.25	1470.4	57.04	2.828	778.1	25.86	1.523	855.2	21.63	1.028	505.2	18.02	0.789	381.1	11.86	0.526
0.30	1795.8	87.28	4.094	1188.8	35.34	2.708	908.2	40.91	2.062	607.8	29.49	1.561	340.7	16.50	0.677
0.35	866.9	48.12	2.690	673.1	40.75	2.080	595.5	36.39	1.862	479.4	29.24	1.453	300.2	18.74	0.829
0.40	999.7	63.03	4.052	460.4	35.80	1.860	413.4	32.88	1.668	358.7	28.43	1.428	260.4	19.77	0.985
0.45	419.9	31.35	2.154	362.8	28.40	1.860	333.9	26.58	1.697	295.6	23.91	1.472	237.7	18.82	1.099
0.50	600.9	47.22	3.805	223.2	20.05	1.403	217.3	18.70	1.360	195.8	18.67	1.318	175.1	17.51	1.186
0.55	503.9	44.58	3.861	294.9	26.89	2.258	221.1	22.12	1.684	190.5	18.20	1.424	197.8	16.72	1.305
0.60	938.4	88.36	8.557	253.3	25.56	2.506	235.6	22.74	2.135	202.5	20.89	1.796	193.3	16.51	1.498
0.65	536.5	55.51	5.741	308.3	37.14	3.299	272.6	31.01	2.902	255.5	23.75	2.442	192.7	15.34	1.718
0.70	619.0	68.92	7.683	375.5	45.67	4.643	326.9	36.25	4.022	261.4	24.74	3.123	187.6	16.08	1.885
0.75	1127.5	134.45	16.066	454.1	52.95	6.460	359.5	42.67	5.087	247.5	29.97	3.418	175.9	17.86	1.939
0.80	1203.7	153.54	19.513	417.4	52.81	6.754	318.4	41.43	5.132	222.4	31.14	3.552	157.4	19.36	1.884
0.85	587.1	82.34	10.744	335.0	47.16	6.123	257.6	40.15	4.679	198.2	30.44	3.540	136.6	20.22	1.838
0.90	285.2	141.09	20.214	243.0	35.44	4.978	191.4	32.56	3.895	153.7	27.49	3.254	117.5	20.49	2.004
0.95	280.8	44.66	6.648	168.6	27.34	3.850	139.8	25.79	3.164	133.4	24.35	2.957	104.2	20.39	2.017
1.00	282.8	38.71	6.149	124.8	24.56	3.157	112.2	22.69	2.813	113.4	22.09	2.756	96.0	20.18	2.000
1.10	288.6	50.30	8.846	154.3	27.38	4.722	125.1	22.75	3.887	95.4	20.91	2.793	80.1	19.99	1.905
1.20	316.4	59.57	11.540	150.7	31.66	5.490	118.3	24.67	4.290	87.7	23.07	3.123	74.8	20.28	2.025
1.30	150.2	36.67	6.428	116.2	31.01	4.964	101.5	28.55	4.307	82.4	25.30	3.419	69.0	20.54	2.131
1.40	219.9	47.97	10.919	119.2	30.58	5.910	88.9	28.37	4.351	73.1	25.25	3.446	61.8	20.39	2.363
1.50	198.9	49.16	11.336	97.0	28.07	5.520	74.7	25.46	4.190	67.0	23.16	3.591	59.8	19.76	2.556
1.60	164.1	42.02	10.641	67.1	25.31	4.337	65.0	24.18	4.140	61.3	21.70	3.702	56.7	18.81	2.672
1.70	63.4	25.44	4.640	60.9	24.23	4.440	58.6	23.10	4.212	55.6	20.96	3.757	53.0	17.68	2.713
1.80	62.7	24.75	5.143	57.5	23.09	4.700	53.8	21.77	4.336	50.0	19.77	3.759	49.0	16.50	2.691
1.90	63.2	25.08	5.780	51.4	23.50	4.681	47.4	22.18	4.252	43.7	20.06	3.629	44.7	15.88	2.607
2.00	50.3	26.69	5.092	42.0	24.79	4.234	38.9	23.23	3.669	36.7	20.81	3.354	40.5	16.36	2.468
2.20	58.6	25.25	7.179	38.2	23.95	4.671	32.5	22.79	3.855	30.2	20.79	3.315	32.5	16.75	2.330
2.40	57.6	22.41	8.404	31.8	21.85	4.637	28.0	20.69	4.037	26.9	19.57	3.443	26.9	16.60	2.481
2.60	67.9	29.62	11.621	30.2	18.86	5.157	26.4	18.62	4.429	23.0	18.03	3.569	24.8	16.11	2.522
2.80	37.6	19.06	7.266	27.3	16.90	5.401	21.4	16.81	4.194	19.4	16.55	3.325	22.6	15.47	2.484
3.00	26.3	15.56	6.231	18.4	15.33	4.154	15.3	15.14	3.379	16.2	15.18	3.042	20.3	14.82	2.562
3.20	16.0	16.75	4.141	13.6	16.07	3.504	13.5	15.45	3.375	13.7	14.34	3.148	18.2	14.19	2.627
3.40	18.5	16.97	4.772	12.5	16.88	3.650	12.4	15.66	3.494	12.5	14.58	3.229	16.2	13.64	2.666
3.60	18.0	16.76	5.893	11.4	16.14	3.707	11.2	15.58	3.539	11.2	14.58	3.258	14.5	13.18	2.680
3.80	10.7	16.20	3.919	10.1	15.70	3.666	9.9	15.23	3.504	10.3	14.39	3.230	12.9	12.83	2.668
4.00	12.7	15.66	5.157	8.9	15.09	3.584	8.7	14.72	3.403	9.2	14.06	3.147	12.1	12.92	2.631

PER = PERIOD (SEC) AA = ABSOLUTE ACC. (GAL) RV = RELATIVE VELOCITY (CM/SEC) RD = RELATIVE DISPLACEMENT (CM)

RESPONSE SPECTRUM

RECORD = S-2107
 DATE AND TIME = 1988-12-17-11-08
 TIME LENGTH = 88.99 (SEC)

COMPONENT = EAST
 SIGNAL = GR. ACC.
 SAMPRING INTERVAL = 0.0100(SEC)
 SKIPPED LENGTH = 0.00 (SEC)

CORRECTION =
 MAX.GROUND ACC. = 262.66 (GAL)
 STATION = CHIBA-S

PER	DAMPING = 0.			DAMPING = 0.025			DAMPING = 0.050			DAMPING = 0.100			DAMPING = 0.250		
	AA	RV	RD	AA	RV	RD	AA	RV	RD	AA	RV	RD	AA	RV	RD
0.05	316.7	1.34	0.020	300.2	0.83	0.019	298.3	0.83	0.019	298.5	0.82	0.019	300.4	0.77	0.019
0.10	1784.9	27.16	0.452	691.5	10.39	0.176	646.7	7.15	0.164	554.9	5.53	0.138	429.4	3.80	0.103
0.15	2001.4	47.26	1.141	884.8	19.83	0.503	687.0	14.79	0.389	521.1	11.53	0.295	424.5	8.14	0.262
0.20	2045.2	65.09	2.072	1040.2	33.77	1.049	811.7	26.14	0.825	571.1	17.87	0.559	360.5	9.50	0.335
0.25	856.0	33.84	1.355	569.5	21.70	0.897	507.2	19.80	0.794	408.6	15.98	0.635	316.3	10.23	0.452
0.30	722.1	33.79	1.646	525.6	19.70	1.195	473.9	16.78	1.076	392.0	14.58	0.880	286.7	10.98	0.598
0.35	1000.4	56.27	3.104	699.6	40.47	2.163	528.8	29.43	1.634	379.5	20.55	1.160	284.2	13.65	0.804
0.40	712.1	44.06	2.886	464.8	32.37	1.881	435.3	30.29	1.751	368.9	26.74	1.473	272.1	17.24	1.013
0.45	1141.7	81.11	5.856	603.3	47.44	3.094	510.9	41.24	2.614	427.3	32.71	2.151	262.6	19.33	1.300
0.50	1204.4	97.57	7.627	723.4	63.77	4.575	602.7	46.15	3.789	467.3	36.15	2.882	277.4	21.83	1.627
0.55	681.9	58.89	5.225	594.9	52.26	4.547	527.3	47.11	4.014	419.4	38.72	3.121	280.5	22.73	1.976
0.60	611.8	58.71	5.579	548.8	57.10	5.004	492.4	52.46	4.463	422.5	42.34	3.751	277.7	23.36	2.221
0.65	1115.8	114.61	11.942	673.3	73.31	7.193	552.2	59.37	5.869	414.1	42.99	4.300	258.0	23.05	2.312
0.70	1046.1	116.31	12.984	543.2	64.38	6.728	456.4	55.74	5.633	342.4	42.08	4.131	223.3	22.70	2.211
0.75	1018.0	139.35	16.710	479.0	65.01	6.817	391.5	55.23	5.534	301.3	41.96	4.156	186.9	24.29	2.278
0.80	1018.0	129.70	16.503	387.0	58.55	6.264	336.1	50.72	5.405	269.8	40.17	4.259	175.5	24.56	2.478
0.85	858.7	112.79	15.312	323.6	50.14	5.916	290.5	45.01	5.276	241.3	36.89	4.262	168.5	23.84	2.565
0.90	343.2	48.27	7.041	267.3	41.48	5.477	242.2	38.11	4.940	205.6	32.45	4.070	155.6	22.44	2.555
0.95	415.7	62.68	9.502	220.2	38.41	5.025	200.6	34.65	4.548	170.7	28.52	3.793	140.6	20.73	2.475
1.00	326.1	54.16	8.260	175.9	37.28	4.447	142.4	34.33	4.082	141.1	28.98	3.458	125.1	19.84	2.365
1.10	258.0	47.59	7.906	153.2	34.36	4.688	124.5	31.74	3.787	109.8	27.43	3.221	96.4	19.01	2.272
1.20	277.5	54.91	10.320	137.8	31.02	5.017	115.5	26.26	4.174	89.5	23.45	3.166	76.2	18.56	2.078
1.30	512.5	66.64	13.377	152.7	34.05	6.525	100.0	25.08	4.248	76.9	19.95	3.153	63.1	17.63	2.145
1.40	148.4	33.39	7.367	82.8	20.74	4.100	69.5	19.50	3.428	62.7	17.75	3.041	58.9	16.89	2.187
1.50	155.3	37.62	8.851	67.4	20.58	3.824	62.4	18.92	3.484	56.2	16.88	3.092	54.6	16.40	2.263
1.60	115.8	31.20	7.510	69.7	20.55	4.513	60.3	21.44	3.873	51.6	17.41	3.190	50.9	16.12	2.360
1.70	162.4	44.48	11.887	71.7	23.54	5.244	62.3	19.70	4.540	49.5	17.12	3.555	47.7	15.98	2.427
1.80	90.1	27.64	7.396	65.5	20.73	5.349	58.8	19.88	4.795	46.2	18.14	3.842	45.2	15.95	2.468
1.90	110.8	34.08	10.134	60.8	21.04	5.550	54.7	20.36	4.979	44.8	18.87	3.973	43.1	16.03	2.486
2.00	127.1	40.37	12.878	58.6	23.11	5.922	51.5	21.41	5.159	40.7	19.55	3.996	41.5	16.20	2.483
2.20	74.7	28.92	9.157	53.1	24.92	6.492	44.6	22.56	5.411	36.2	19.98	4.239	39.1	16.73	2.673
2.40	62.0	28.64	9.040	42.9	23.25	6.259	37.3	21.12	5.373	30.4	18.96	4.192	37.1	17.29	3.088
2.60	58.1	24.23	9.951	32.2	22.18	5.469	28.8	20.58	4.822	26.6	19.63	4.289	35.1	18.13	3.233
2.80	30.1	22.66	5.983	28.2	22.07	5.571	26.8	21.55	5.198	26.0	20.69	4.557	32.8	19.01	3.381
3.00	28.0	24.11	6.585	26.4	23.48	5.965	25.2	22.91	5.581	23.4	21.91	4.908	30.4	19.80	3.489
3.20	26.9	25.25	6.969	24.0	24.58	6.169	23.0	23.96	5.772	21.7	22.87	5.081	27.9	20.48	3.626
3.40	22.8	26.13	6.662	21.2	25.42	6.199	20.5	24.76	5.788	19.7	23.59	5.093	25.6	21.03	3.660
3.60	19.9	24.72	6.520	18.5	25.97	6.043	17.8	25.29	5.655	17.4	24.09	4.968	23.3	21.45	3.608
3.80	28.1	26.97	10.282	15.8	26.24	5.725	15.0	25.56	5.356	15.1	24.38	4.729	21.2	21.75	3.581
4.00	19.1	26.91	7.732	13.4	26.22	5.374	13.3	25.58	5.133	13.9	24.46	4.713	19.3	21.92	3.795

PER = PERIOD (SEC) AA = ABSOLUTE ACC. (GAL) RV = RELATIVE VELOCITY (CM/SEC) RD = RELATIVE DISPLACEMENT (CM)

RESPONSE SPECTRUM

RECORD = S-2107 COMPONENT = DOWN SIGNAL = GR. ACC. CORRECTION = STATION = CHIBA-S
 DATE AND TIME = 1988-12-17-11-08 SAMPRING INTERVAL = 0.0100(SEC) MAX.GROUND ACC. = 113.45 (GAL)
 TIME LENGTH = 88.99 (SEC) SKIPPED LENGTH = 0.00 (SEC)

PER	DAMPING = 0.			DAMPING = 0.025			DAMPING = 0.050			DAMPING = 0.100			DAMPING = 0.250		
	AA	RV	RD	AA	RV	RD	AA	RV	RD	AA	RV	RD	AA	RV	RD
0.05	202.1	1.17	0.013	137.8	0.67	0.009	138.2	0.61	0.009	137.5	0.62	0.009	132.4	0.52	0.008
0.10	1023.5	16.38	0.259	580.3	9.12	0.147	389.1	6.13	0.098	283.1	4.01	0.066	171.3	2.05	0.041
0.15	1015.8	24.45	0.579	388.6	8.38	0.421	266.8	5.69	0.221	192.6	4.12	0.110	165.2	2.86	0.085
0.20	1175.8	36.69	1.192	483.9	15.58	0.487	360.2	10.73	0.364	251.6	7.36	0.252	137.0	4.11	0.127
0.25	565.8	22.42	0.896	197.5	8.39	0.312	170.9	6.80	0.270	140.3	5.64	0.219	110.0	3.71	0.155
0.30	596.3	28.34	1.359	232.2	11.15	0.531	182.8	9.14	0.416	136.2	6.70	0.305	87.4	4.04	0.174
0.35	683.9	36.80	2.060	281.8	16.09	0.873	192.7	10.72	0.592	128.4	7.13	0.389	79.8	4.12	0.210
0.40	336.7	21.08	1.565	106.4	7.90	0.432	109.6	7.47	0.442	90.0	6.63	0.356	65.9	4.47	0.218
0.45	334.9	24.60	1.718	127.8	9.40	0.654	102.8	8.51	0.524	78.1	6.92	0.391	55.4	4.48	0.240
0.50	266.5	21.38	1.688	128.8	11.09	0.814	100.0	8.73	0.630	71.7	6.83	0.445	51.2	4.53	0.284
0.55	203.2	17.66	1.557	114.8	11.36	0.877	79.1	9.06	0.603	67.4	6.63	0.499	48.2	4.47	0.315
0.60	145.9	15.46	1.331	90.1	8.84	0.821	70.2	6.73	0.534	59.1	5.61	0.518	43.9	4.22	0.324
0.65	215.9	22.42	2.311	86.7	9.62	0.928	55.5	8.43	0.588	47.8	5.60	0.490	38.0	4.55	0.322
0.70	167.8	18.51	2.082	80.7	8.47	0.999	63.2	7.14	0.777	43.1	6.09	0.511	35.4	4.39	0.363
0.75	221.5	26.29	3.155	93.9	11.08	1.335	67.6	8.76	0.957	45.2	6.67	0.629	34.0	4.37	0.414
0.80	292.3	37.10	4.738	96.7	13.56	1.564	69.5	9.64	1.120	50.2	6.58	0.793	32.3	4.45	0.457
0.85	145.0	20.08	2.654	72.9	11.52	1.332	57.9	9.39	1.054	45.5	6.95	0.809	31.3	4.77	0.482
0.90	128.9	20.09	2.645	64.5	11.30	1.363	45.7	9.56	0.933	39.5	7.42	0.788	29.1	4.97	0.488
0.95	76.3	12.03	1.744	52.4	10.20	1.195	43.8	8.82	0.890	35.0	7.00	0.779	26.4	5.04	0.481
1.00	115.8	18.51	2.933	51.9	8.94	1.313	40.7	8.01	1.020	30.8	6.77	0.760	23.4	4.98	0.463
1.10	78.3	15.24	2.399	40.2	8.10	1.228	32.9	6.87	0.963	25.0	5.42	0.717	17.7	4.60	0.447
1.20	44.4	8.54	1.621	25.1	6.33	0.915	21.2	5.54	0.765	17.9	4.51	0.621	15.3	4.11	0.476
1.30	108.3	22.35	4.635	25.9	5.80	1.106	17.1	4.47	0.726	15.7	4.25	0.644	14.1	3.72	0.496
1.40	37.8	8.69	1.878	20.8	4.82	1.029	17.1	4.51	0.840	15.1	4.25	0.712	13.0	3.71	0.509
1.50	42.4	10.18	2.418	18.6	4.86	0.947	14.5	4.09	0.816	13.5	4.12	0.728	11.8	3.69	0.508
1.60	43.0	11.42	2.789	18.7	4.96	1.209	13.9	4.35	0.886	12.1	4.17	0.737	10.5	3.64	0.490
1.70	37.9	10.83	2.776	18.5	5.78	1.350	13.6	4.98	0.989	10.1	4.24	0.687	9.8	3.56	0.465
1.80	24.6	8.83	2.018	16.9	6.60	1.383	13.1	5.41	1.061	9.6	4.23	0.761	9.4	3.45	0.494
1.90	30.2	9.07	2.763	11.6	5.14	1.060	10.1	4.88	0.916	8.8	4.45	0.758	9.0	3.61	0.517
2.00	23.8	7.80	2.407	11.8	6.00	1.188	10.1	5.55	0.999	8.5	4.86	0.805	8.5	3.72	0.530
2.20	25.7	9.27	3.149	13.4	6.60	1.634	11.1	5.96	1.347	8.8	5.06	0.972	7.7	3.93	0.573
2.40	35.7	13.80	5.214	14.8	7.62	2.154	11.2	6.08	1.616	8.1	5.10	1.077	7.1	4.05	0.651
2.60	21.2	8.99	3.637	12.5	6.81	2.131	9.7	6.12	1.640	7.4	5.17	1.142	6.6	4.02	0.755
2.80	10.5	5.94	2.092	9.0	5.54	1.771	8.0	5.20	1.535	7.3	4.63	1.277	6.5	3.89	0.817
3.00	9.0	5.19	2.057	8.1	4.90	1.829	7.4	4.71	1.645	6.7	4.37	1.360	6.2	3.76	0.843
3.20	8.0	5.69	2.070	7.2	4.98	1.862	6.6	4.50	1.880	5.7	4.21	1.385	5.7	3.71	0.847
3.40	9.4	6.64	2.763	7.1	5.39	2.063	5.6	4.90	1.821	4.9	4.32	1.324	5.1	3.80	0.885
3.60	13.7	8.13	4.506	6.9	5.86	2.247	5.6	5.23	1.831	4.5	4.53	1.375	4.6	3.86	0.968
3.80	11.3	7.42	4.118	6.1	5.60	2.210	5.1	5.12	1.810	4.3	4.61	1.457	4.1	3.91	1.031
4.00	7.0	6.06	2.839	5.1	5.37	2.074	4.4	5.02	1.702	4.0	4.58	1.503	3.9	3.94	1.075

PER = PERIOD (SEC) AA = ABSOLUTE ACC. (GAL) RV = RELATIVE VELOCITY (CM/SEC) RD = RELATIVE DISPLACEMENT (CM)

S-2107 CHIBA-S

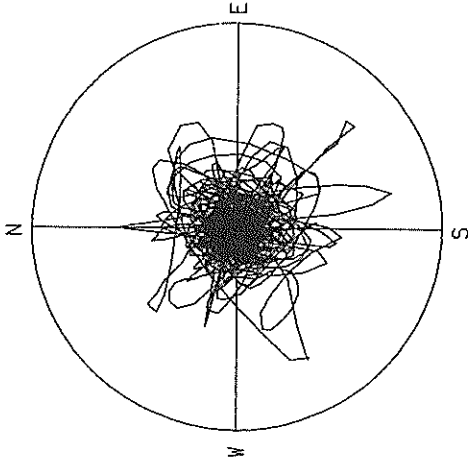

ACCELERATION
R=400.0 GAL
MAX=309.0 GAL

S-2107 CHIBA-S

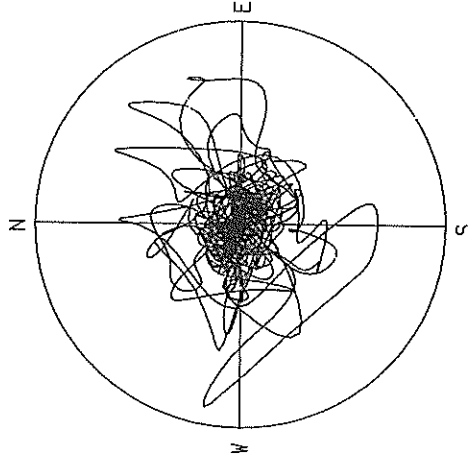

VELOCITY
R=20.0 CM/SEC.
MAX=18.2 CM/SEC.

S-2107 CHIBA-S

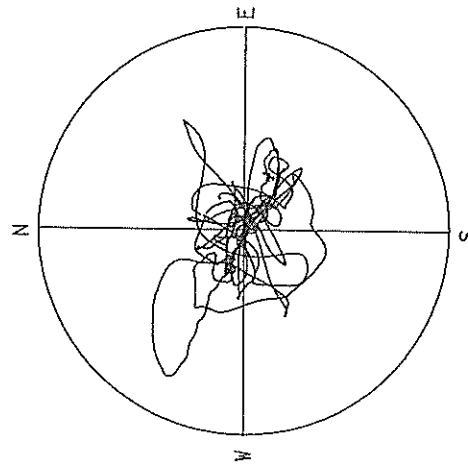

DISPLACEMENT
R=4.00 CM
MAX=3.22 CM

RECORD NUMBER
STATION

S-2110
KASHIMA-ZOKAN-S

EARTHQUAKE DATA

DATA AND TIME
LOCATION OF HYPOCENTER
EPCENTRAL REGION
LATITUDE
LONGITUDE
DEPTH
MAGNITUDE

11: 8 DEC.17,1987

CHIBA-KEN-TOHO-OKI
35°22' N
140°30' E
58KM
6.7

PEAK VALUES OF COMPONENTS

N S E W U D HORIZONTAL*

PARAMETER OF THE VARIABLE FILTER

FC (HZ)
MAXIMUM ACCELERATION (GAL)

0.181 0.157 0.242

ORIGINAL
CORRECTED
MAXIMUM VELOCITY (CM/SEC)

99.5 70.4 30.1 102.6
133.1 134.6 54.5 142.3

FIXED FILTER
VARIABLE FILTER
MAXIMUM DISPLACEMENT (CM)

8.60 7.01 2.95 9.71
10.28 7.77 2.38 10.53

FIXED FILTER
VARIABLE FILTER

3.175 1.955 1.324 3.181
2.398 1.719 0.861 2.430

* RESULTANT OF HORIZONTAL COMPONENTS

S-2110 KASHIMA-ZOKAN-S

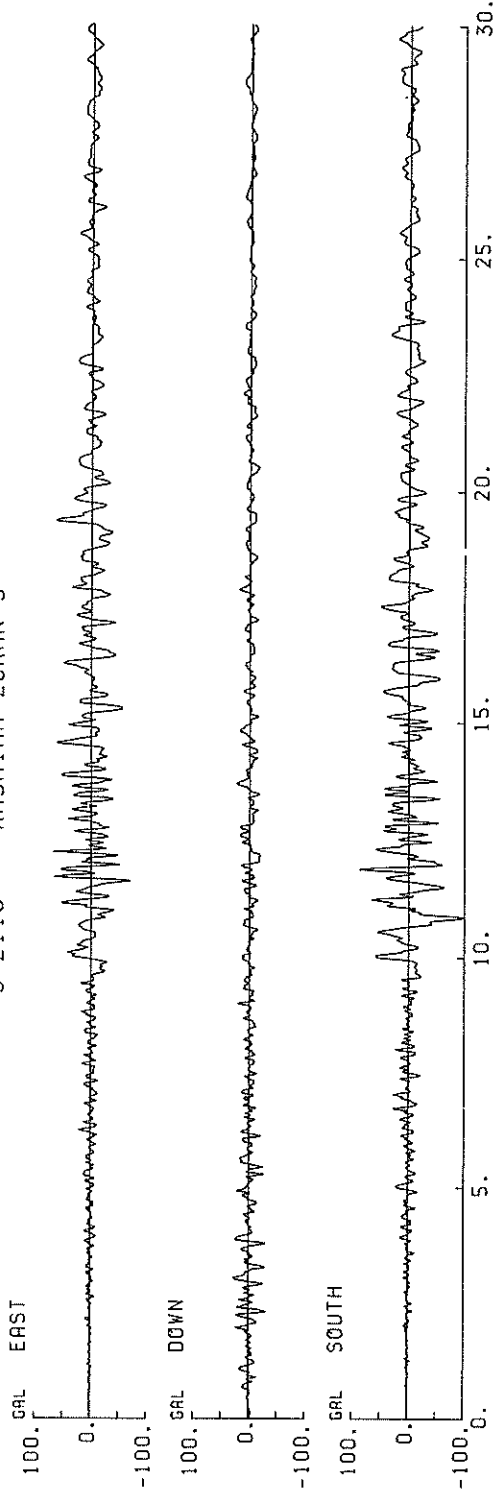

TIME (SECONDS)

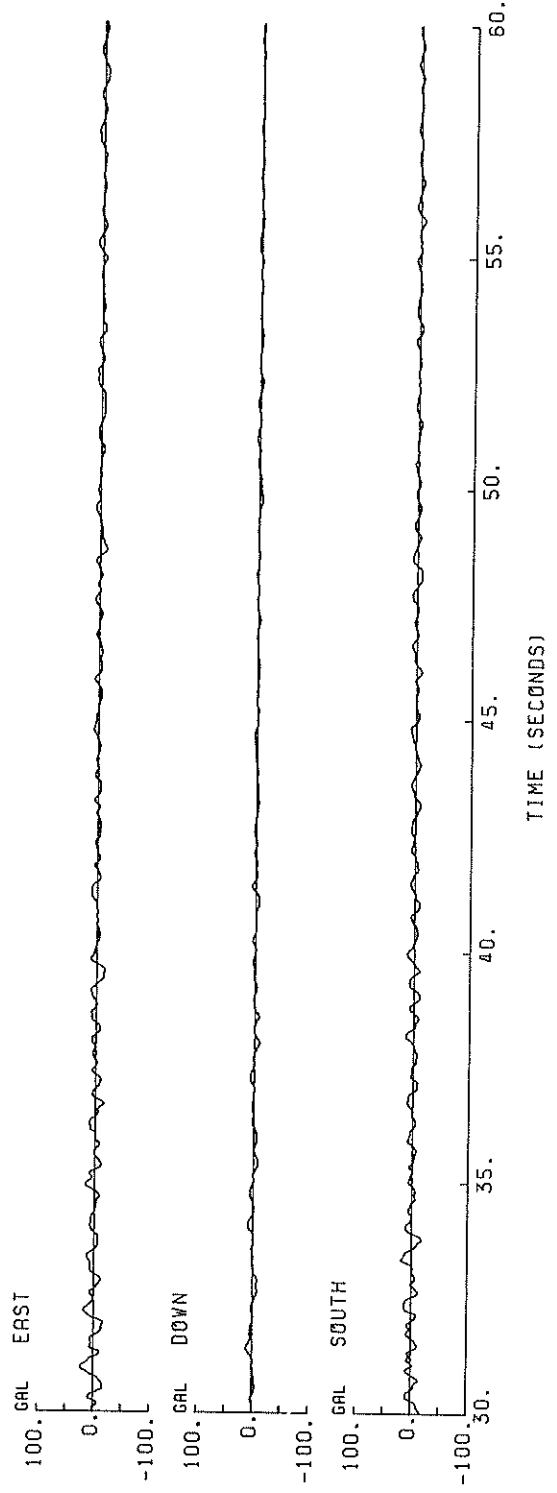

TIME (SECONDS)

S-2110 SOUTH KASHIMA-ZOKAN-S

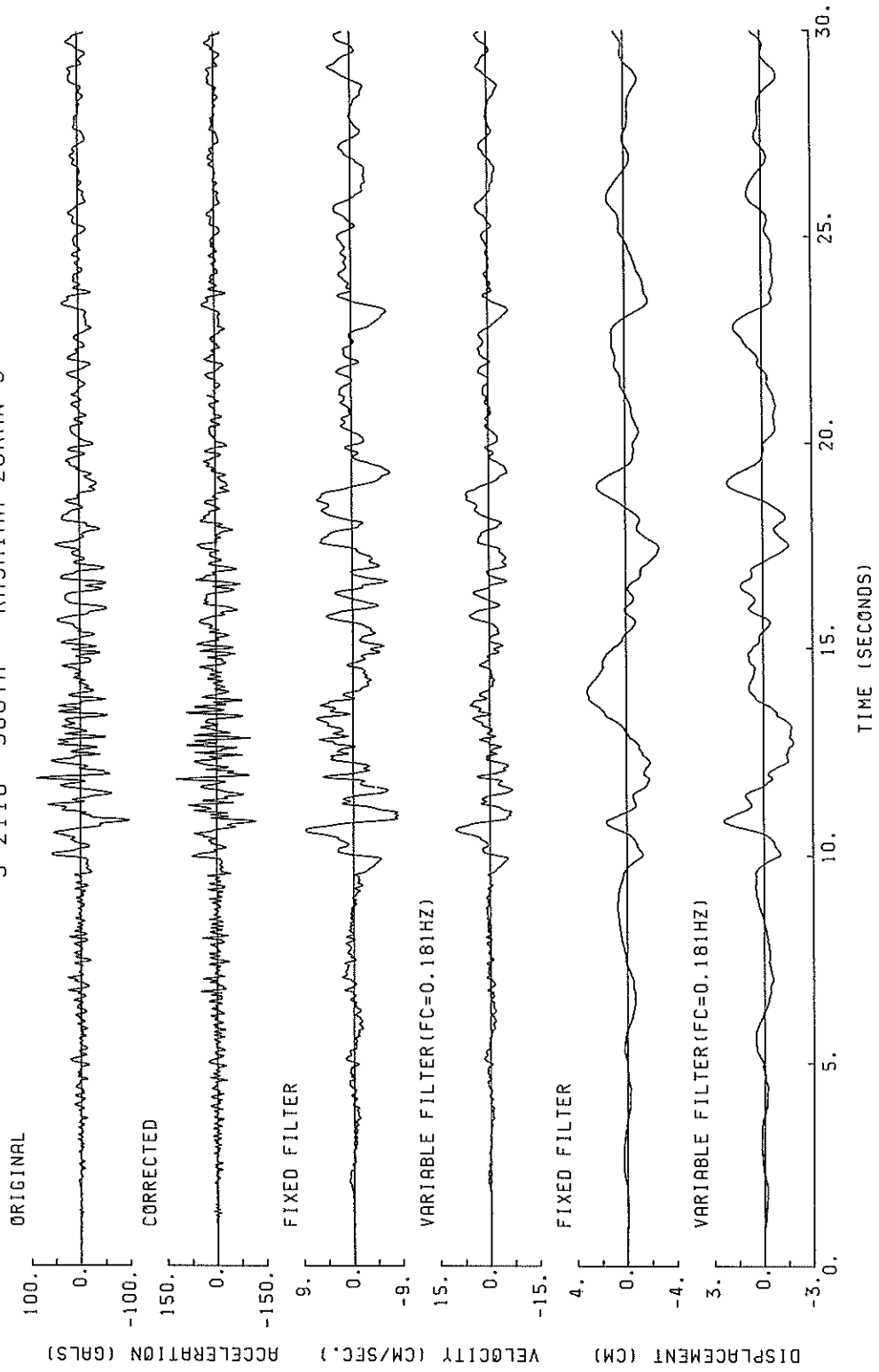

S-2110 SOUTH KASHIMA-ZOKAN-S

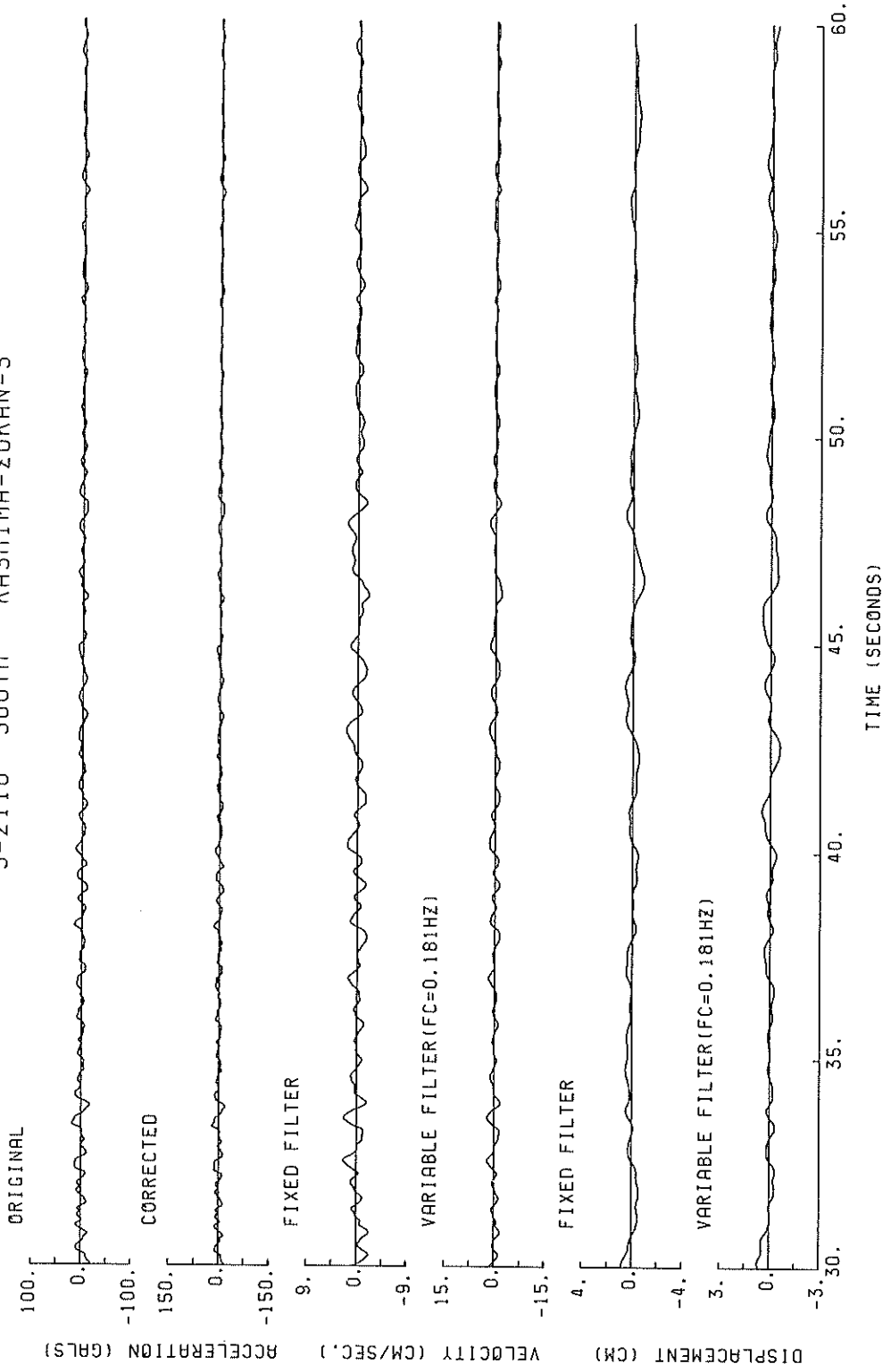

S-2110 EAST KASHIMA-ZOKAN-S

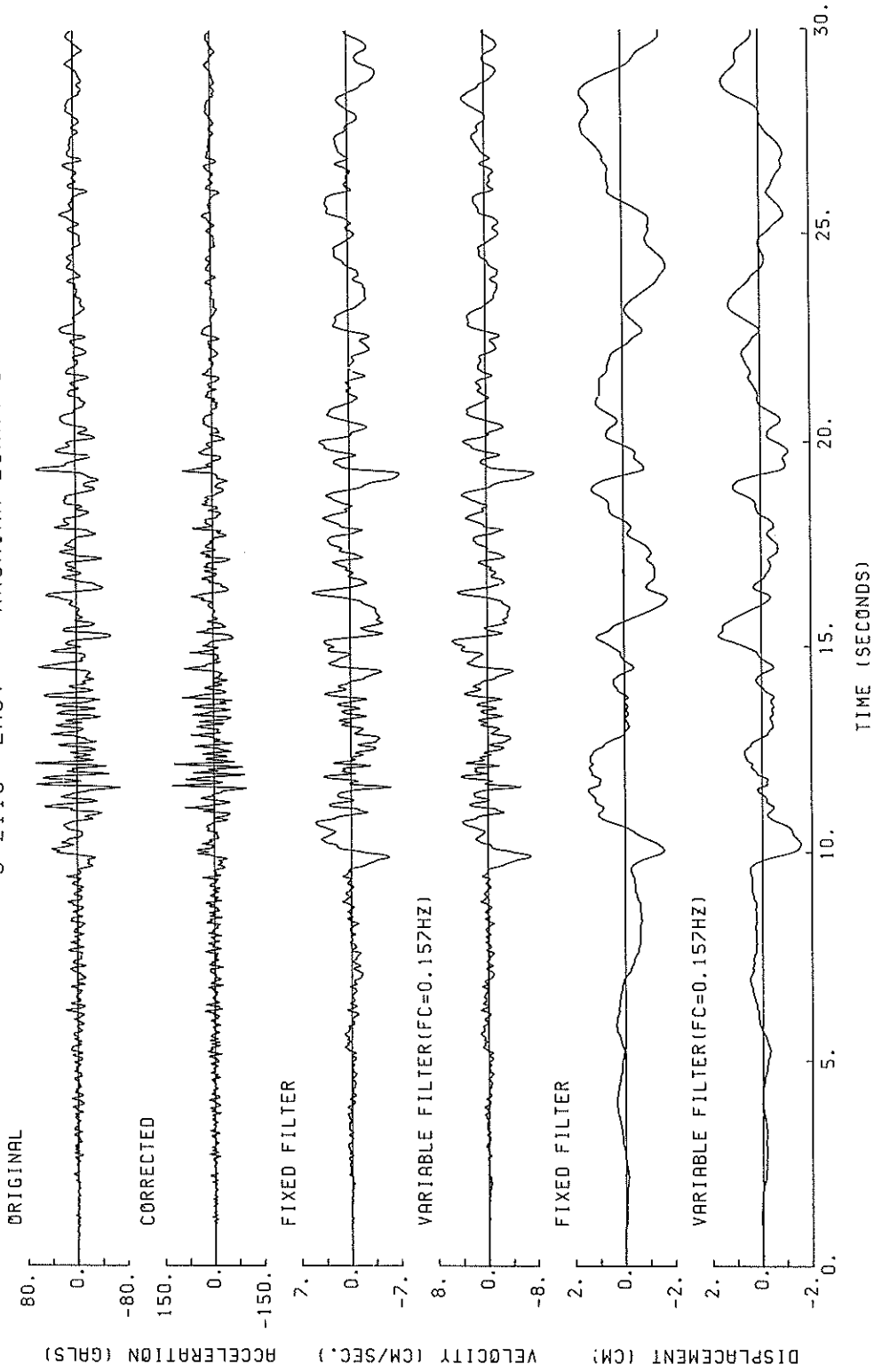

S-2110 EAST KASHIMA-ZOKAN-S

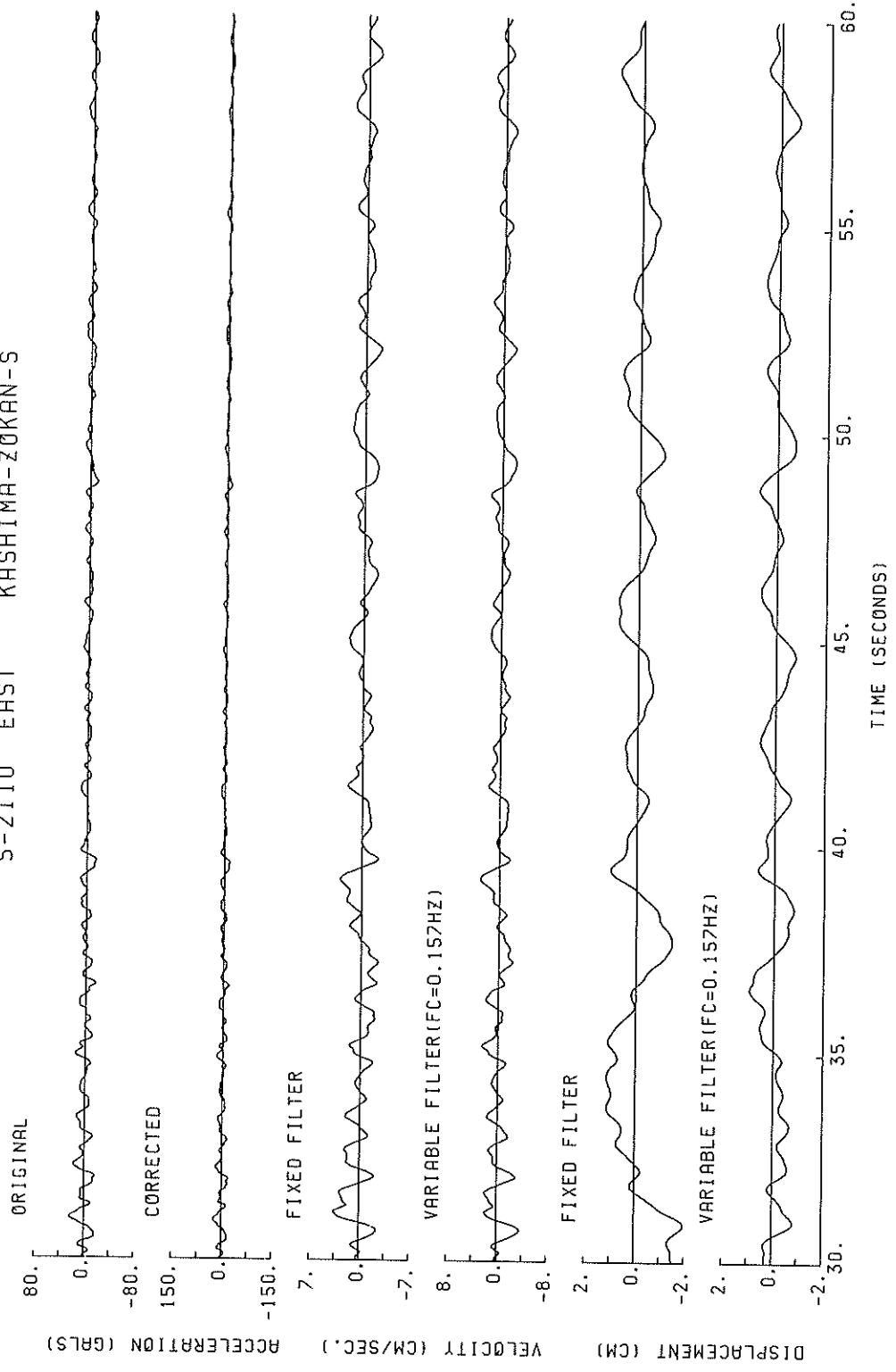

S-2110 DOWN KASHIMA-ZOKAN-S

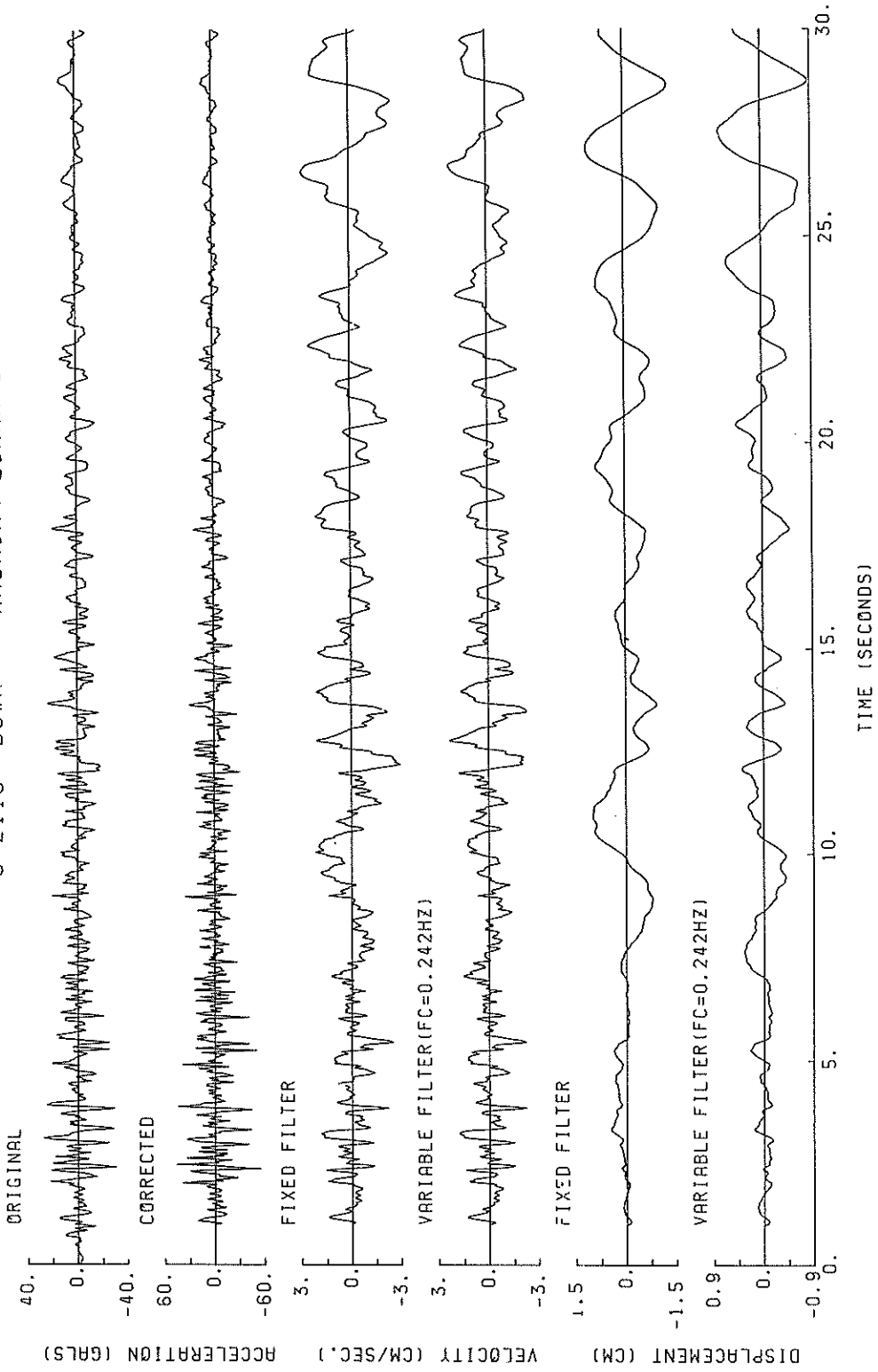

S-2110 DOWN KASHIMA-ZOKKAN-S

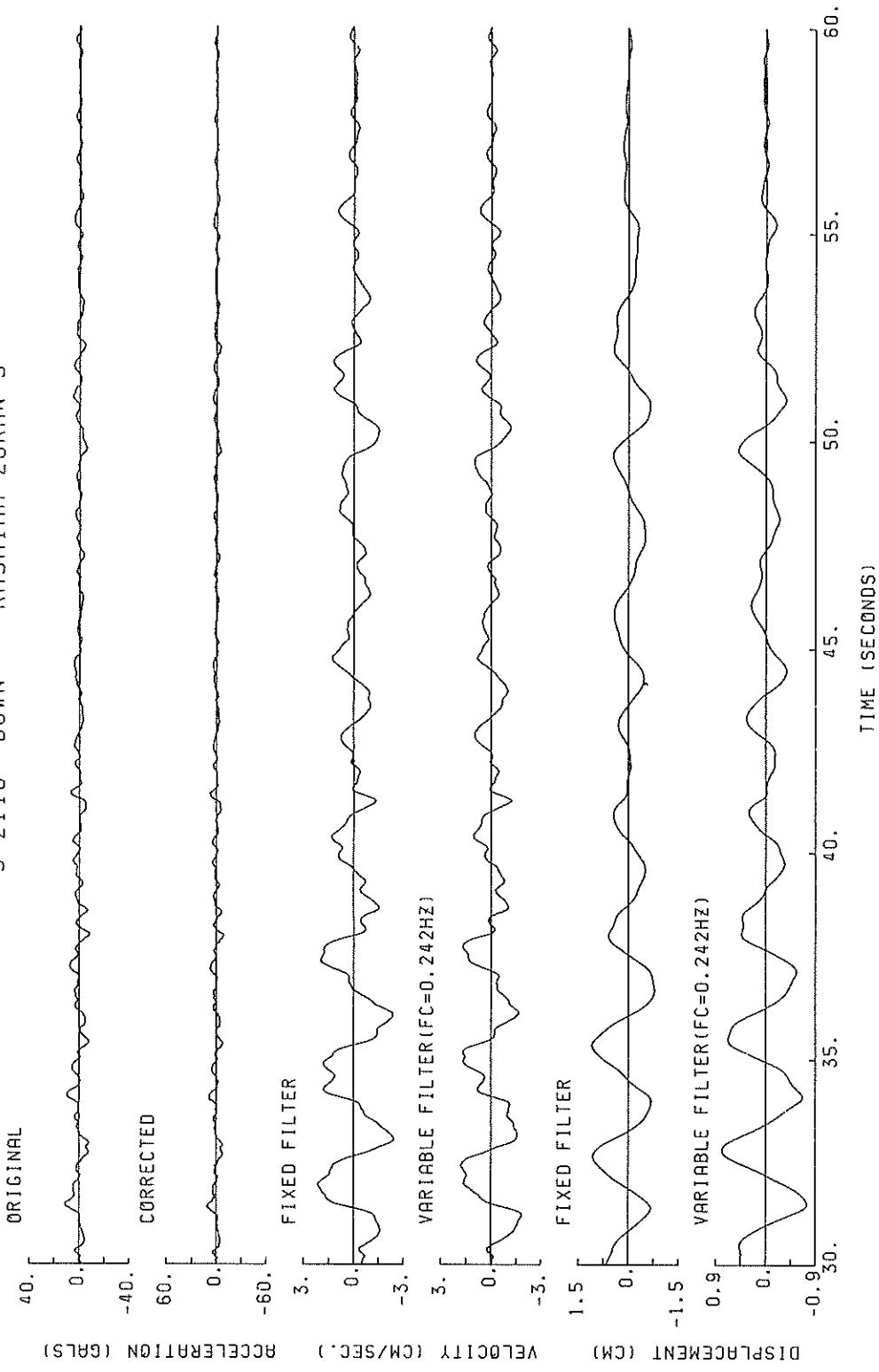

S-2110 SOUTH KASHIMA-ZOKAN-S
(1/FC=5.52 SEC.)

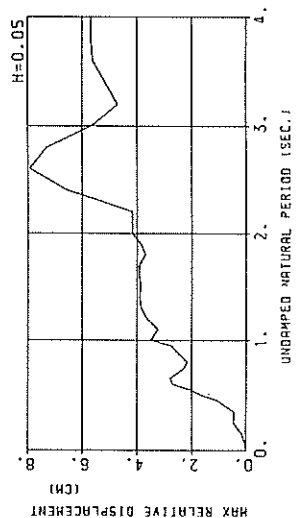
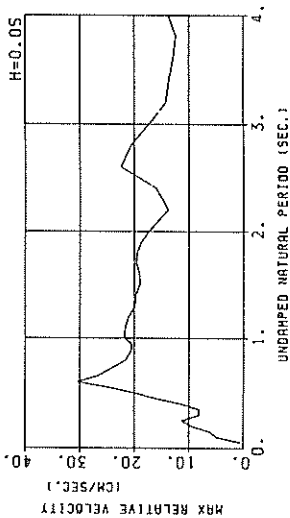
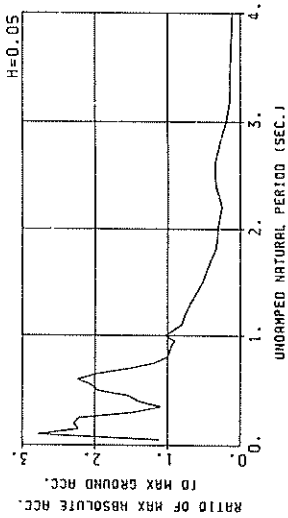

RESPONSE SPECTRA

S-2110 EAST KASHIMA-ZOKAN-S
(1/FC=6.38 SEC.)

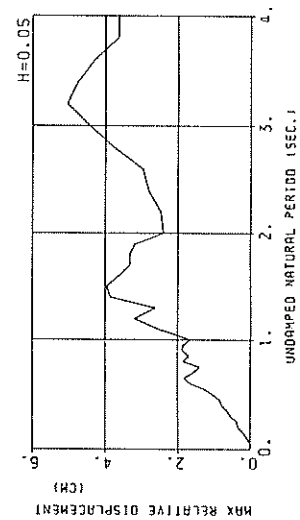
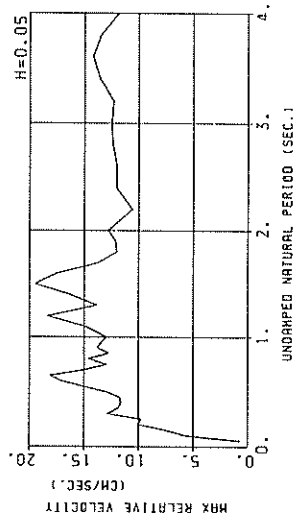
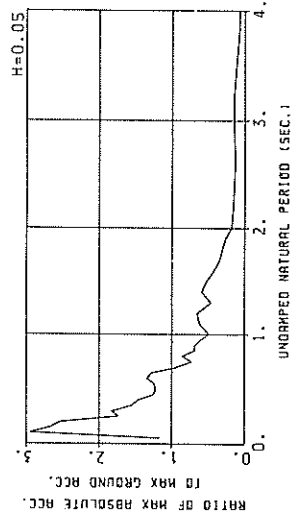

RESPONSE SPECTRA

S-2110 DOWN KASHIMA-ZOKAN-S
(1/FC=4.13 SEC.)

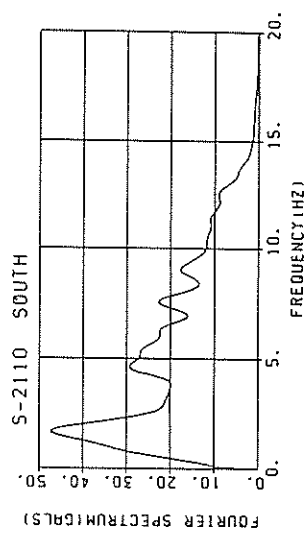
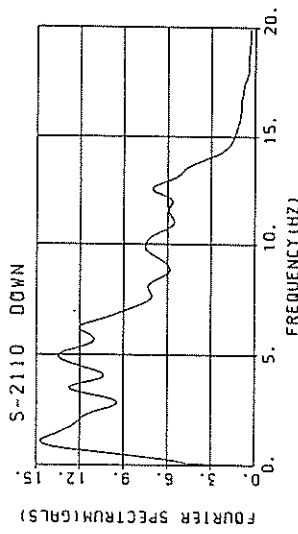
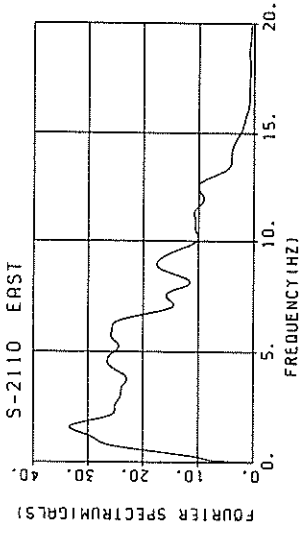
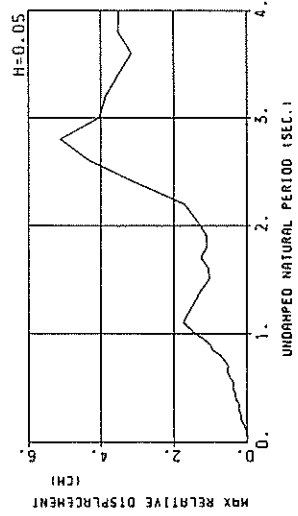
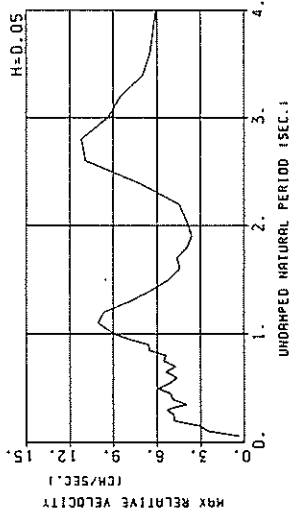
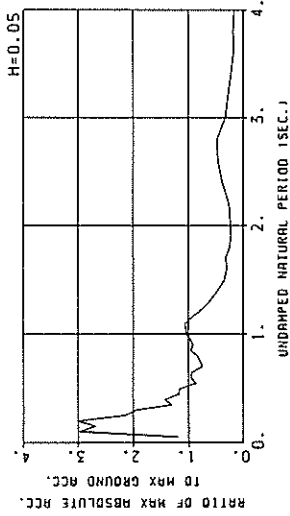

RESPONSE SPECTRA

FOURIER SPECTRA

RESPONSE SPECTRUM

RECORD = S-2110 COMPONENT = SOUTH SIGNAL = GR. ACC. CORRECTION = STATION = KASHIMA-ZOKAN-S
 DATE AND TIME = 1987-12-17-11-08 SAMPRING INTERVAL = 0.0100(SEC) MAX. GROUND ACC. = 133.13 (GAL)
 TIME LENGTH = 59.99 (SEC) SKIPPED LENGTH = 0.00 (SEC)

PER	DAMPING = 0.				DAMPING = 0.025				DAMPING = 0.050				DAMPING = 0.100				DAMPING = 0.250			
	AA	RV	RD	AA	RV	RD	AA	RV	RD	AA	RV	RD	AA	RV	RD	AA	RV	RD		
0.05	162.6	0.47	0.810	146.7	0.44	0.809	146.5	0.40	0.800	146.2	0.39	0.809	145.4	0.35	0.809	145.4	0.35	0.809		
0.10	1190.1	18.73	0.301	488.7	6.79	0.123	369.7	4.75	0.093	254.6	3.17	0.064	181.6	1.81	0.044	181.6	1.81	0.044		
0.15	692.9	14.91	0.395	342.1	7.67	0.196	296.2	6.23	0.168	266.8	4.89	0.152	195.7	3.42	0.103	195.7	3.42	0.103		
0.20	398.3	44.11	1.417	405.6	12.90	0.304	304.5	9.41	0.309	276.7	7.55	0.277	193.2	5.33	0.178	193.2	5.33	0.178		
0.25	533.1	21.03	0.844	303.7	12.14	0.480	294.8	11.36	0.465	233.8	9.31	0.381	155.5	6.02	0.225	155.5	6.02	0.225		
0.30	500.9	22.65	1.142	231.0	10.03	0.527	198.3	8.13	0.447	162.6	6.74	0.361	122.7	5.29	0.255	122.7	5.29	0.255		
0.35	440.0	13.98	0.565	189.8	9.15	0.588	144.3	8.02	0.446	122.7	6.55	0.373	113.5	5.11	0.332	113.5	5.11	0.332		
0.40	495.3	31.75	2.007	215.6	13.69	1.128	186.3	11.28	0.751	138.0	8.88	0.546	120.5	5.88	0.461	120.5	5.88	0.461		
0.45	887.8	62.87	4.554	296.2	22.95	1.515	206.4	16.35	1.050	159.2	11.08	0.810	134.1	6.86	0.639	134.1	6.86	0.639		
0.50	792.9	62.38	5.021	359.5	26.97	2.877	261.1	19.92	1.642	197.0	13.84	1.225	143.6	7.20	0.824	143.6	7.20	0.824		
0.55	823.3	71.89	6.309	374.9	34.50	2.873	272.2	24.69	2.007	200.0	16.07	1.502	142.9	8.52	0.972	142.9	8.52	0.972		
0.60	588.6	58.49	5.368	393.5	40.36	3.583	298.5	30.49	2.707	201.6	20.02	1.803	134.1	9.61	1.069	134.1	9.61	1.069		
0.65	705.1	72.25	7.547	311.8	32.53	3.327	261.1	26.93	2.775	189.5	19.25	1.982	121.6	10.36	1.141	121.6	10.36	1.141		
0.70	487.5	53.65	6.050	243.1	29.80	3.013	203.8	25.04	2.516	162.0	19.23	1.959	109.3	11.41	1.207	109.3	11.41	1.207		
0.75	332.4	39.22	4.736	169.1	25.49	2.407	157.5	23.28	2.231	132.9	18.78	1.843	99.5	11.83	1.276	99.5	11.83	1.276		
0.80	419.1	53.18	6.795	146.7	23.61	2.376	134.1	21.54	2.164	118.5	17.98	1.875	93.2	11.79	1.358	93.2	11.79	1.358		
0.85	286.6	38.92	5.245	141.9	23.11	2.594	129.0	20.94	2.347	113.1	17.65	2.017	89.5	12.11	1.456	89.5	12.11	1.456		
0.90	237.1	34.05	4.865	138.5	22.66	2.837	126.3	20.44	2.575	107.9	17.67	2.159	86.6	13.05	1.566	86.6	13.05	1.566		
0.95	197.4	30.32	4.515	129.3	21.45	2.956	120.3	20.53	2.750	102.1	18.51	2.275	84.2	13.53	1.689	84.2	13.53	1.689		
1.00	414.7	65.30	10.506	188.6	30.58	4.772	137.8	21.80	3.476	96.0	19.17	2.581	81.8	13.83	1.820	81.8	13.83	1.820		
1.10	194.3	34.55	6.017	112.8	22.96	3.449	106.3	21.63	3.232	95.2	19.01	2.846	76.3	13.76	2.061	76.3	13.76	2.061		
1.20	259.3	49.96	9.457	113.9	23.14	4.150	100.1	21.03	3.621	89.5	17.69	3.156	70.8	14.12	2.240	70.8	14.12	2.240		
1.30	189.5	39.32	8.110	105.5	23.59	4.511	90.5	19.84	3.852	80.6	18.14	3.341	65.9	14.76	2.350	65.9	14.76	2.350		
1.40	192.0	43.17	9.533	101.2	23.45	5.017	79.2	19.74	3.904	70.6	18.51	3.415	60.2	15.09	2.405	60.2	15.09	2.405		
1.50	102.2	25.48	5.823	71.0	19.30	4.035	68.1	19.00	3.847	62.0	18.09	3.427	54.0	15.22	2.422	54.0	15.22	2.422		
1.60	83.0	21.73	5.381	65.0	19.79	4.205	61.1	19.06	3.914	54.8	17.89	3.417	47.9	15.18	2.399	47.9	15.18	2.399		
1.70	137.1	38.06	10.034	65.6	20.81	4.793	53.8	19.65	3.891	47.6	17.78	3.319	42.0	14.98	2.330	42.0	14.98	2.330		
1.80	87.8	24.85	7.208	59.5	20.91	4.876	45.3	19.46	3.690	39.7	17.57	3.071	36.6	14.63	2.215	36.6	14.63	2.215		
1.90	132.4	40.63	12.108	59.4	20.23	5.424	42.3	18.70	3.852	36.0	16.82	3.128	31.9	14.16	2.350	31.9	14.16	2.350		
2.00	83.7	26.57	8.484	54.9	18.27	5.552	41.6	17.34	4.177	33.5	15.79	3.299	30.5	13.84	2.525	30.5	13.84	2.525		
2.20	49.8	17.84	6.110	32.7	14.22	4.002	34.3	13.80	4.163	33.7	13.89	3.992	27.8	12.76	2.845	27.8	12.76	2.845		
2.40	64.7	26.28	9.440	52.0	19.29	7.576	46.4	16.03	6.576	36.1	13.34	5.110	25.7	12.10	3.035	25.7	12.10	3.035		
2.60	83.2	35.26	14.255	59.6	27.08	10.196	45.5	22.40	7.934	32.5	16.83	5.401	22.7	11.47	2.985	22.7	11.47	2.985		
2.80	87.6	39.13	17.391	48.7	24.58	9.664	37.2	20.63	7.303	25.7	16.17	4.921	20.8	10.83	2.831	20.8	10.83	2.831		
3.00	43.7	23.13	9.958	30.7	19.84	6.982	25.2	17.33	5.673	19.6	13.85	4.263	18.9	10.56	2.843	18.9	10.56	2.843		
3.20	24.7	16.05	6.410	21.1	14.87	5.459	18.2	14.18	4.701	17.0	12.70	4.161	17.1	10.25	2.795	17.1	10.25	2.795		
3.40	25.6	14.99	7.499	21.0	14.26	6.150	17.8	13.61	5.174	15.7	12.51	4.313	15.3	10.39	2.890	15.3	10.39	2.890		
3.60	29.9	18.78	9.815	21.4	13.22	6.993	17.3	12.87	5.627	14.6	12.18	4.495	13.7	10.45	2.879	13.7	10.45	2.879		
3.80	35.5	21.78	12.981	18.9	13.57	6.909	15.7	12.36	5.681	12.7	11.77	4.389	12.4	10.43	2.793	12.4	10.43	2.793		
4.00	26.9	18.34	10.899	17.9	15.61	7.241	14.2	13.76	5.672	10.3	11.41	4.020	11.3	10.37	2.951	11.3	10.37	2.951		

PER = PER100 (SEC) AA = ABSOLUTE ACC. (GAL) RV = RELATIVE VELOCITY (CM/SEC) RD = RELATIVE DISPLACEMENT (CM)

RESPONSE SPECTRUM

RECORD = S-2110 COMPONENT = EAST SIGNAL = GR. ACC. CORRECTION = STATION = KASHIMA-ZOKAN-S
 DATE AND TIME = 1987-12-17-11-08 SAMPRING INTERVAL = 0.0100(SEC) MAX.GROUND ACC. = 134.56 (GAL)
 TIME LENGTH = 59.99 (SEC) SKIPPED LENGTH = 0.00 (SEC)

PER	DAMPING = 0.			DAMPING = 0.025			DAMPING = 0.050			DAMPING = 0.100			DAMPING = 0.250		
	AA	RV	RD	AA	RV	RD	AA	RV	RD	AA	RV	RD	AA	RV	RD
0.05	167.8	0.69	0.011	153.3	0.54	0.010	155.1	0.55	0.010	155.6	0.52	0.010	153.9	0.46	0.010
0.10	898.0	14.09	0.227	447.2	6.60	0.114	397.5	5.65	0.101	311.3	4.19	0.078	209.4	2.34	0.050
0.15	803.7	18.38	0.458	431.6	9.59	0.245	356.5	7.70	0.201	285.3	5.83	0.157	205.0	3.92	0.105
0.20	890.5	27.66	0.902	470.8	14.87	0.479	339.2	10.01	0.343	240.1	7.61	0.239	163.2	4.76	0.147
0.25	800.5	31.60	1.267	320.5	13.36	0.505	233.7	9.77	0.367	184.9	6.94	0.287	140.7	5.52	0.194
0.30	815.6	28.87	1.485	279.4	14.28	0.636	245.2	12.89	0.556	191.8	10.47	0.427	116.8	6.75	0.239
0.35	565.6	30.74	1.755	278.4	14.87	0.863	208.3	11.88	0.644	154.7	9.18	0.485	107.6	6.55	0.286
0.40	849.0	53.58	3.441	283.4	17.63	1.148	197.0	11.61	0.795	136.4	8.17	0.544	94.6	5.77	0.344
0.45	482.6	33.67	2.475	235.3	16.06	1.204	167.3	11.72	0.853	125.3	9.13	0.633	88.8	5.83	0.413
0.50	219.8	18.82	1.392	172.8	13.74	1.092	164.2	12.90	1.034	133.7	9.99	0.826	87.4	5.92	0.486
0.55	731.8	63.53	5.607	256.2	23.26	1.960	167.3	15.15	1.277	112.8	10.66	0.848	78.0	6.41	0.519
0.60	454.4	39.48	3.970	258.4	24.21	2.355	180.2	17.08	1.657	109.8	10.59	0.969	76.7	6.25	0.621
0.65	454.4	47.11	4.863	235.1	24.43	2.511	172.0	18.15	1.831	122.5	12.34	1.289	76.1	6.97	0.732
0.70	186.8	20.74	2.319	144.8	17.16	1.796	127.7	15.26	1.577	107.4	12.33	1.307	73.1	7.81	0.820
0.75	328.8	38.64	4.685	115.7	15.38	1.648	97.7	12.92	1.385	94.9	11.65	1.326	69.7	8.33	0.886
0.80	141.1	19.15	2.288	136.6	17.73	2.211	114.8	14.61	1.851	91.5	11.76	1.452	65.6	8.67	0.938
0.85	330.4	44.67	6.047	109.3	15.02	1.998	92.8	12.75	1.688	82.1	11.53	1.468	61.1	8.85	0.979
0.90	279.3	40.83	5.731	123.3	17.86	2.564	91.8	13.79	1.869	73.3	11.04	1.444	56.6	8.93	1.010
0.95	381.1	57.08	8.711	121.6	18.01	2.777	81.2	13.41	1.844	64.6	10.68	1.436	52.5	8.95	1.036
1.00	176.9	28.12	4.482	81.8	14.78	2.070	65.5	12.99	1.653	58.7	10.55	1.445	48.9	8.98	1.055
1.10	195.0	34.60	5.975	119.2	20.26	3.649	83.4	14.88	2.545	61.4	12.10	1.826	42.2	8.94	1.096
1.20	269.7	51.05	9.838	117.7	24.10	4.288	87.8	18.37	3.183	58.3	12.70	2.075	41.2	8.58	1.247
1.30	121.2	25.44	5.190	79.6	17.82	3.404	61.5	13.81	2.614	53.2	11.63	2.199	41.3	8.18	1.429
1.40	170.1	38.57	8.445	96.9	21.42	4.903	78.4	18.27	3.861	57.6	11.94	2.755	39.4	8.30	1.529
1.50	213.3	51.18	12.156	89.8	24.40	5.108	70.1	19.49	3.968	49.9	14.01	2.744	35.6	8.54	1.526
1.60	148.5	37.79	9.630	77.8	22.81	5.035	56.0	17.43	3.620	38.2	13.90	2.440	30.8	9.13	1.589
1.70	64.3	18.26	4.710	48.0	14.17	3.503	45.7	13.75	3.316	37.5	12.06	2.662	29.0	9.38	1.706
1.80	54.6	17.41	4.478	46.0	13.81	3.769	40.8	12.03	3.318	33.7	11.15	2.647	27.8	9.43	1.783
1.90	60.4	19.00	5.528	42.8	14.04	3.910	34.9	12.15	3.171	28.9	11.27	2.484	26.2	9.39	1.814
2.00	45.0	17.13	4.562	26.6	14.19	2.694	24.0	12.83	2.598	23.5	11.29	2.170	24.4	9.32	1.819
2.20	28.7	11.45	3.521	21.8	11.06	2.660	20.3	10.57	2.470	19.4	9.84	2.248	21.2	9.04	1.816
2.40	44.3	19.93	6.463	24.7	13.04	3.591	19.4	12.07	2.805	17.2	10.59	2.397	18.9	8.78	1.865
2.60	31.0	14.86	5.309	21.4	12.95	3.659	17.4	12.00	2.962	14.3	10.61	2.323	17.5	8.62	1.973
2.80	72.5	32.44	14.405	29.5	14.20	5.841	19.2	12.41	3.784	13.8	10.40	2.555	16.5	8.42	2.130
3.00	55.3	27.26	12.613	25.0	14.85	5.681	19.9	12.49	4.430	16.6	9.79	3.400	15.8	8.04	2.271
3.20	32.3	16.85	8.376	24.0	14.18	6.214	19.8	12.34	5.047	16.4	9.82	3.790	14.9	8.07	2.318
3.40	48.4	26.15	14.165	22.6	15.11	6.606	16.3	13.56	4.740	15.6	11.39	3.565	13.6	8.36	2.241
3.60	27.8	17.77	9.123	16.1	15.78	5.292	13.3	14.23	4.282	10.4	12.00	3.236	12.2	8.89	2.067
3.80	15.7	15.88	5.755	12.0	14.55	4.370	10.0	13.46	3.635	8.3	11.78	2.756	10.8	9.02	1.939
4.00	16.1	12.54	6.530	10.5	12.25	4.258	9.1	11.86	3.636	7.9	11.02	2.844	9.5	9.02	1.912

PER = PERIOD (SEC) AA = ABSOLUTE ACC. (GAL) RV = RELATIVE VELOCITY (CM/SEC) RD = RELATIVE DISPLACEMENT (CM)

RESPONSE SPECTRUM

REPORT = S-2110 COMPONENT = DOWN SIGNAL = GR. ACC. STATION = KASHIHA-ZOKAN-S
 DATE AND TIME = 1987-12-17-11-08 SAMPRING INTERVAL = 0.0100(SEC) MAX.GROUND ACC. = 54.55 (GAL)
 TIME LENGTH = 59.99 (SEC) SKIPPED LENGTH = 0.00 (SEC) CORRECTION =

PER	DAMPING = 0.				DAMPING = 0.025				DAMPING = 0.050				DAMPING = 0.100				DAMPING = 0.250			
	AA	RV	RD	AA	AA	RV	RD	AA	AA	RV	RD	AA	AA	RV	RD	AA	AA	RV	RD	
0.05	82.3	0.46	0.005	65.7	0.28	0.004	0.004	63.7	0.27	0.004	0.004	64.0	0.25	0.004	0.004	63.1	0.20	0.004	0.004	
0.10	592.0	9.37	0.150	206.2	3.27	0.052	0.052	161.8	2.49	0.041	0.041	112.6	1.68	0.028	0.028	82.0	1.00	0.020	0.020	
0.15	309.3	6.92	0.176	198.1	4.17	0.113	0.113	146.2	3.05	0.084	0.084	104.9	1.62	0.059	0.059	81.2	1.37	0.042	0.042	
0.20	370.9	11.62	0.376	215.5	6.56	0.218	0.218	164.7	4.83	0.167	0.167	111.7	3.41	0.112	0.112	75.1	2.25	0.068	0.068	
0.25	190.6	7.37	0.302	121.4	5.04	0.193	0.193	116.3	4.81	0.184	0.184	101.0	4.11	0.157	0.157	64.4	2.51	0.092	0.092	
0.30	289.8	13.55	0.661	161.9	7.22	0.322	0.322	105.6	5.32	0.240	0.240	73.3	3.67	0.165	0.165	49.7	2.36	0.100	0.100	
0.35	189.5	10.23	0.588	76.1	4.69	0.256	0.256	71.1	3.96	0.220	0.220	65.2	3.57	0.198	0.198	49.8	2.06	0.158	0.158	
0.40	292.3	18.24	1.185	98.7	8.51	0.401	0.401	78.0	4.90	0.313	0.313	63.4	3.70	0.251	0.251	46.5	2.39	0.164	0.164	
0.45	231.7	16.49	1.188	83.0	5.62	0.425	0.425	63.6	5.04	0.324	0.324	52.6	3.98	0.264	0.264	41.2	2.76	0.180	0.180	
0.50	147.5	11.40	0.934	79.8	7.29	0.504	0.504	63.1	5.92	0.397	0.397	48.9	4.56	0.303	0.303	35.0	2.98	0.184	0.184	
0.55	269.9	23.49	2.068	66.0	5.69	0.505	0.505	46.5	5.10	0.355	0.355	38.2	4.24	0.287	0.287	28.3	3.03	0.192	0.192	
0.60	173.2	8.78	0.850	66.1	5.88	0.603	0.603	51.8	4.62	0.470	0.470	38.4	3.71	0.342	0.342	25.2	2.91	0.203	0.203	
0.65	174.1	18.42	1.864	75.4	7.97	0.807	0.807	50.9	5.40	0.542	0.542	37.9	4.05	0.395	0.395	24.7	2.75	0.237	0.237	
0.70	110.8	12.29	1.575	49.8	5.69	0.617	0.617	40.4	4.71	0.499	0.499	32.0	4.21	0.390	0.390	24.7	2.81	0.269	0.269	
0.75	194.6	22.99	2.773	65.2	8.27	0.927	0.927	42.6	5.52	0.604	0.604	31.3	4.29	0.436	0.436	24.5	2.91	0.303	0.303	
0.80	172.1	8.91	1.169	49.1	5.70	0.795	0.795	45.4	5.39	0.733	0.733	35.8	4.27	0.569	0.569	24.0	2.92	0.346	0.346	
0.85	135.4	18.36	2.478	64.7	8.24	1.182	1.182	52.3	6.55	0.952	0.952	38.6	4.85	0.689	0.689	23.2	2.82	0.402	0.402	
0.90	134.4	19.25	2.757	56.6	7.87	1.160	1.160	49.5	6.59	1.010	1.010	37.5	5.10	0.757	0.757	24.0	2.84	0.450	0.450	
0.95	168.6	25.58	3.854	67.1	10.18	1.532	1.532	52.0	7.91	1.182	1.182	37.1	5.47	0.831	0.831	24.0	3.01	0.487	0.487	
1.00	158.7	25.39	4.019	73.6	11.88	1.860	1.860	56.5	8.94	1.423	1.423	39.1	5.94	0.968	0.968	23.4	3.44	0.514	0.514	
1.10	129.2	22.71	3.961	74.5	12.76	2.279	2.279	57.6	10.05	1.753	1.753	39.0	7.04	1.170	1.170	21.6	4.01	0.584	0.584	
1.20	107.3	20.50	3.914	53.3	11.51	1.943	1.943	44.0	9.64	1.598	1.598	32.6	7.04	1.160	1.160	19.6	4.16	0.628	0.628	
1.30	66.6	14.81	2.850	39.6	8.98	1.495	1.495	33.5	7.89	1.424	1.424	26.4	6.25	1.104	1.104	17.3	3.99	0.627	0.627	
1.40	91.5	20.48	4.543	35.3	7.62	1.751	1.751	28.5	6.44	1.254	1.254	20.7	5.19	1.002	1.002	14.7	3.66	0.627	0.627	
1.50	25.5	6.44	1.455	19.3	5.70	1.095	1.095	18.4	5.18	1.035	1.035	16.6	4.53	0.910	0.910	13.1	3.58	0.629	0.629	
1.60	42.7	11.12	2.771	20.9	5.00	1.356	1.356	16.2	4.40	1.050	1.050	13.0	4.19	0.834	0.834	11.6	3.36	0.620	0.620	
1.70	39.6	10.66	2.902	21.8	5.98	1.594	1.594	17.2	4.60	1.255	1.255	13.3	3.45	0.958	0.958	10.3	3.29	0.665	0.665	
1.80	21.9	6.23	1.799	16.0	4.50	1.310	1.310	13.4	3.88	1.091	1.091	12.1	3.42	0.976	0.976	10.1	3.21	0.748	0.748	
1.90	24.8	8.16	2.455	14.7	4.60	1.343	1.343	12.1	3.60	1.101	1.101	11.2	3.28	1.005	1.005	10.1	3.13	0.830	0.830	
2.00	14.4	5.65	1.462	13.8	4.36	1.400	1.400	12.6	3.80	1.267	1.267	11.2	3.65	1.114	1.114	10.2	3.06	0.917	0.917	
2.20	26.7	9.56	3.271	16.4	5.22	2.007	2.007	14.0	4.47	1.709	1.709	12.7	4.13	1.528	1.528	10.3	2.97	1.108	1.108	
2.40	33.9	12.18	4.951	25.6	9.06	3.731	3.731	21.0	7.34	3.047	3.047	15.8	5.31	2.257	2.257	10.1	3.40	1.293	1.293	
2.60	58.2	24.04	9.974	34.3	14.37	5.868	5.868	25.3	10.92	4.507	4.507	17.2	7.02	2.809	2.809	9.5	3.86	1.410	1.410	
3.00	71.0	31.78	14.090	36.6	17.00	7.262	7.262	25.9	11.23	5.123	5.123	16.0	7.91	3.103	3.103	8.4	4.18	1.431	1.431	
3.20	27.6	13.86	6.286	21.9	11.40	4.983	4.983	17.8	9.38	4.040	4.040	13.3	7.26	2.960	2.960	7.5	4.31	1.458	1.458	
3.40	26.1	13.72	6.783	18.9	10.34	4.882	4.882	15.0	8.51	3.871	3.871	11.0	6.58	2.774	2.774	6.5	4.29	1.458	1.458	
3.60	16.2	9.38	4.739	14.0	8.03	4.101	4.101	12.1	6.95	3.582	3.582	9.4	5.82	2.644	2.644	6.2	4.13	1.561	1.561	
3.80	12.2	7.87	3.990	10.7	7.17	3.492	3.492	9.7	6.47	3.146	3.146	8.3	5.44	2.649	2.649	5.9	3.88	1.633	1.633	
4.00	16.6	10.88	6.071	11.2	7.32	4.100	4.100	9.7	6.25	3.522	3.522	7.8	4.97	2.744	2.744	5.4	3.55	1.656	1.656	
4.20	14.2	10.19	5.735	10.7	7.34	4.311	4.311	8.7	6.08	3.495	3.495	6.8	4.55	2.619	2.619	5.0	3.21	1.633	1.633	

PER = PER100 (SEC) AA = ABSOLUTE ACC. (GAL) RV = RELATIVE VELOCITY (CH/SEC) RD = RELATIVE DISPLACEMENT (CH)

S-2110 KASHIMA-ZOKAN-S

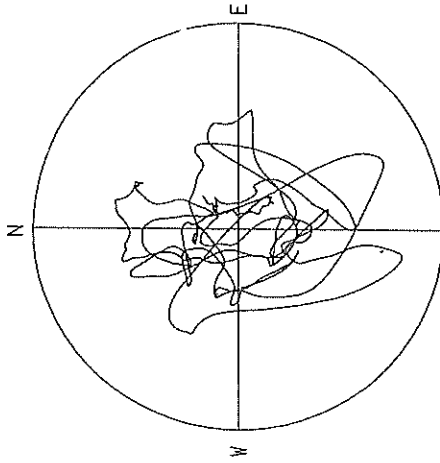

DISPLACEMENT
R=3.00 CM
MAX=2.43 CM

S-2110 KASHIMA-ZOKAN-S

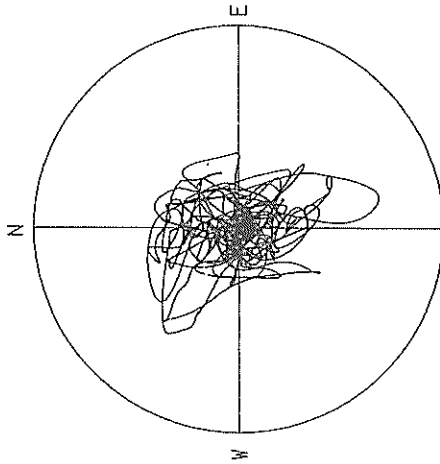

VELOCITY
R=15.0 CM/SEC.
MAX=10.5 CM/SEC.

S-2110 KASHIMA-ZOKAN-S

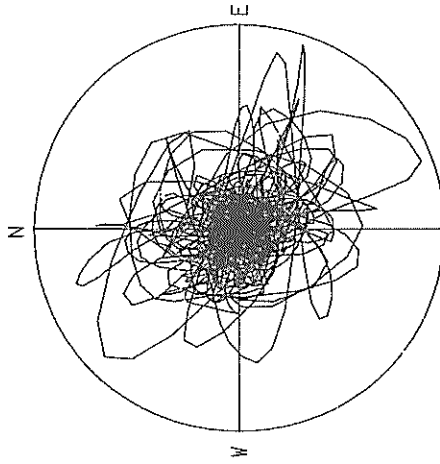

ACCELERATION
R=150.0 GAL
MAX=142.3 GAL

RECORD NUMBER
STATION

S-2111 SHINAGAWA-S

EARTHQUAKE DATA

DATA AND TIME *****
11: 8 DEC.17,1987 *****
LOCATION OF HYPOCENTER *****
EPICENTRAL REGION *****
LATITUDE *****
LONGITUDE *****
DEPTH *****
MAGNITUDE *****

CHIBA-KEN-TOHO-OKI *****
35°22' N *****
140°30' E *****
58KM *****
6.7 *****

PEAK VALUES OF COMPONENTS

N S E W U D HORIZONTAL*

PARAMETER OF THE VARIABLE FILTER

FC (HZ) 0.256 0.218 0.585
MAXIMUM ACCELERATION (GAL)

ORIGINAL
CORRECTED

114.3 96.7 19.8 127.7
122.9 109.2 26.0 135.7

MAXIMUM VELOCITY (CM/SEC)

FIXED FILTER
VARIABLE FILTER
14.94 10.53 2.11 15.39
13.18 9.99 1.86 14.97

MAXIMUM DISPLACEMENT (CM)

FIXED FILTER
VARIABLE FILTER
2.157 1.659 0.686 2.435
2.204 1.252 0.205 2.299

* RESULTANT OF HORIZONTAL COMPONENTS

S-2111 SHINAGAWA-S

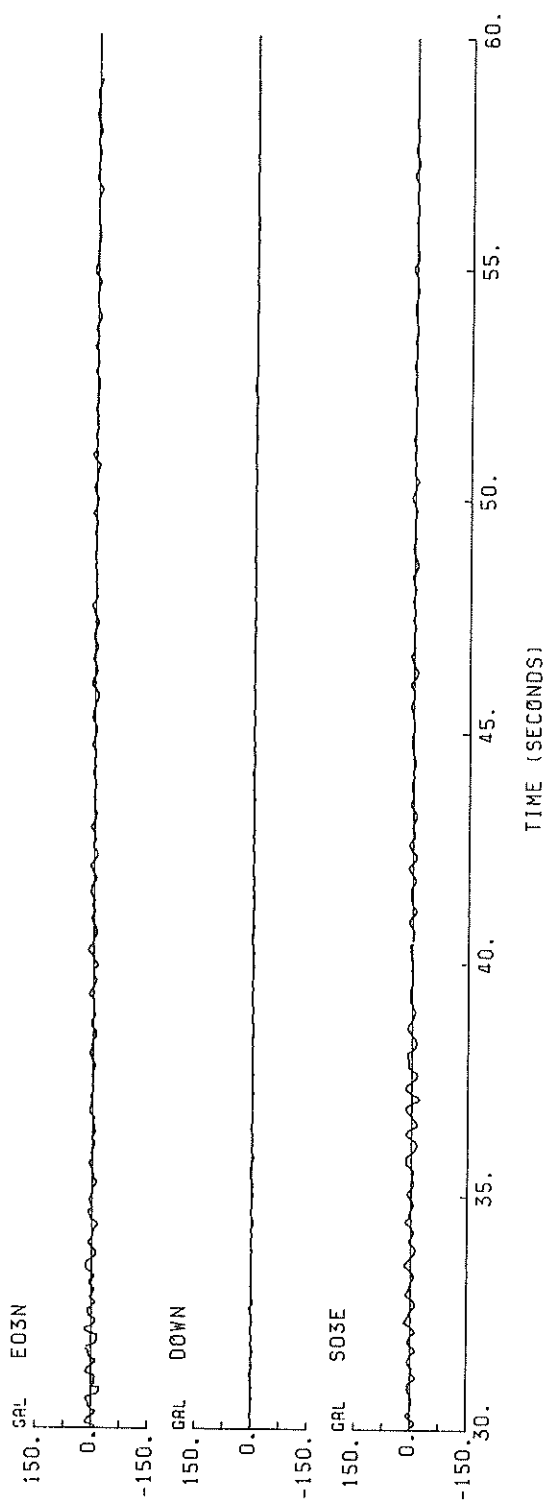
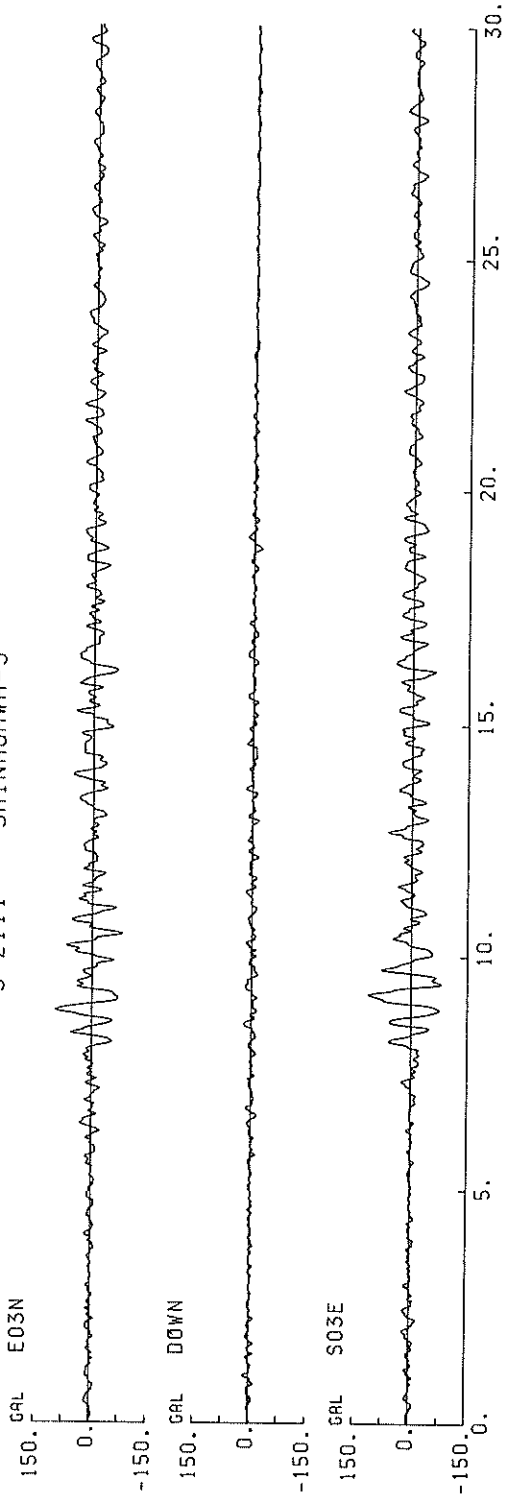

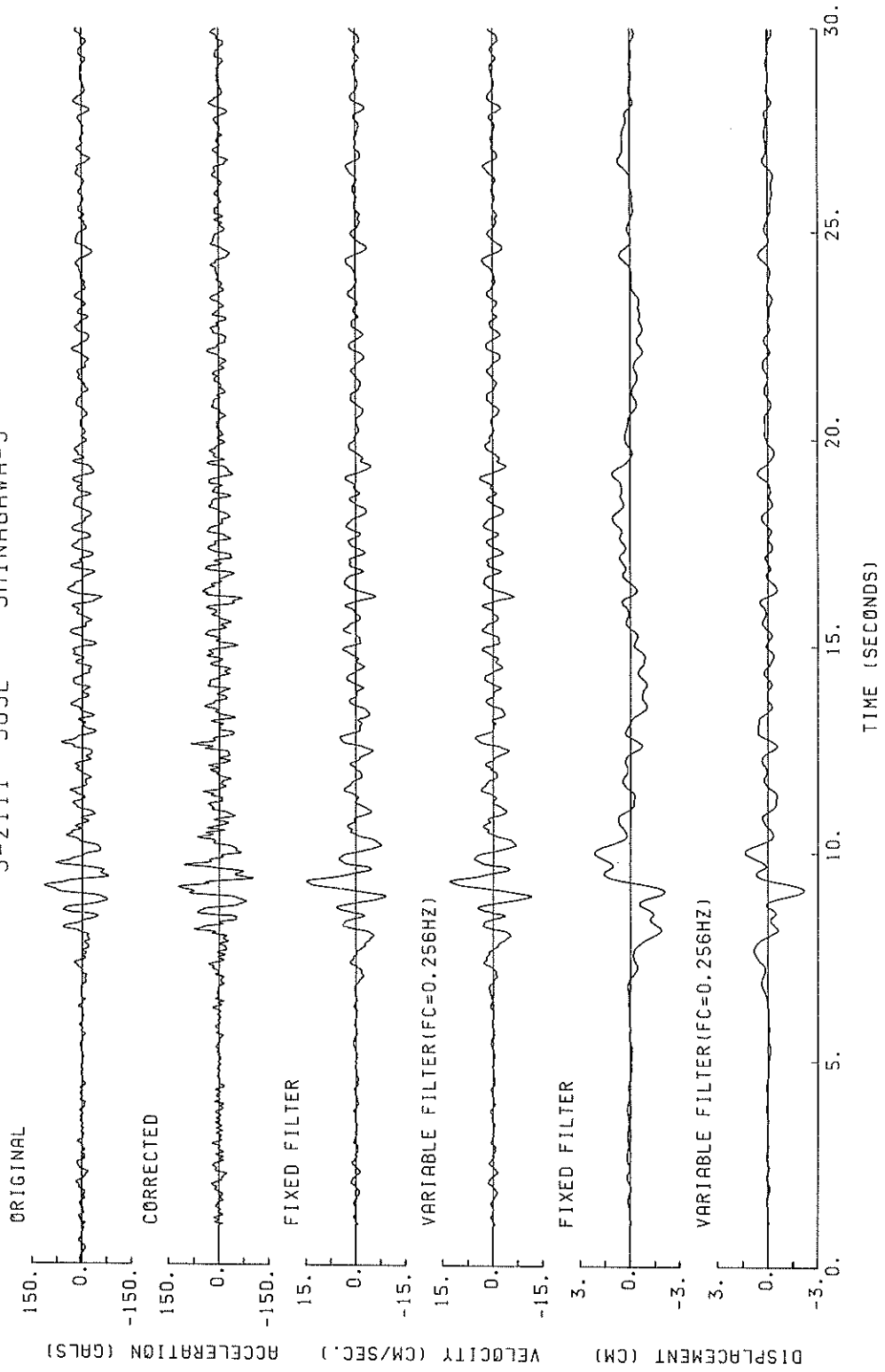

S-2111 SO3E SHINAGAWA-S

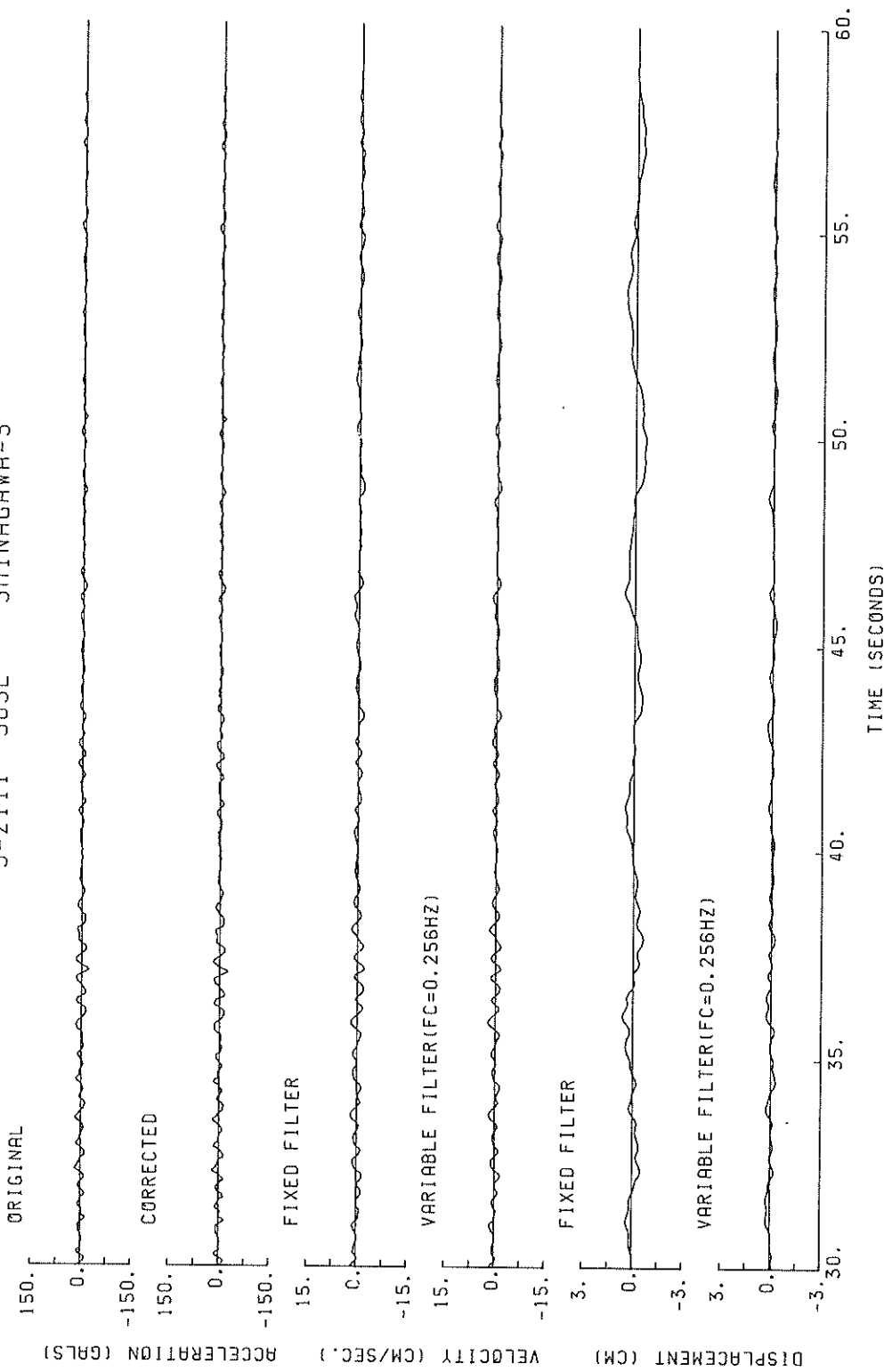

S-2111 E03N SHINAGAWA-S

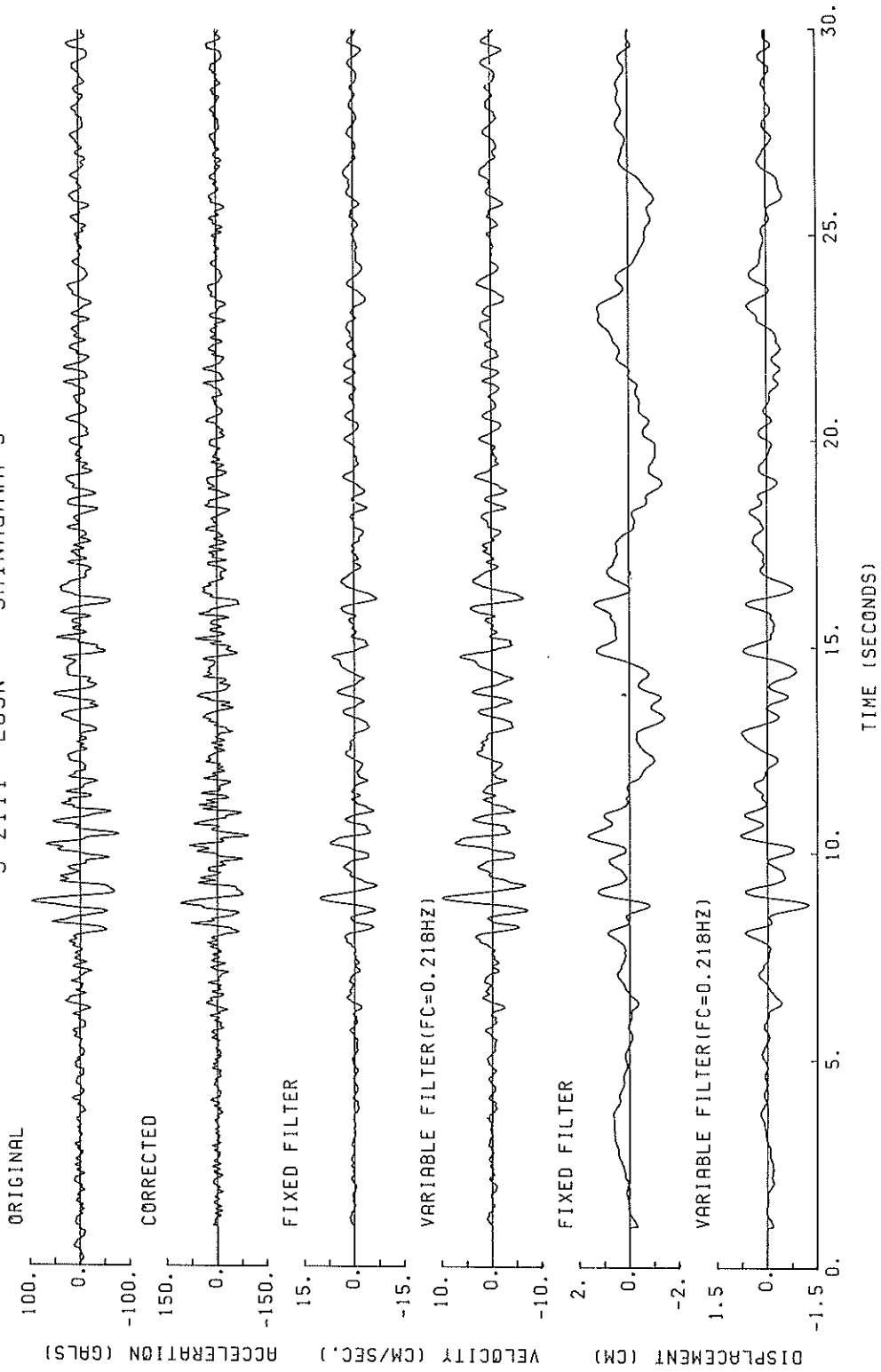

S-2111 E03N SHINAGAWA-S

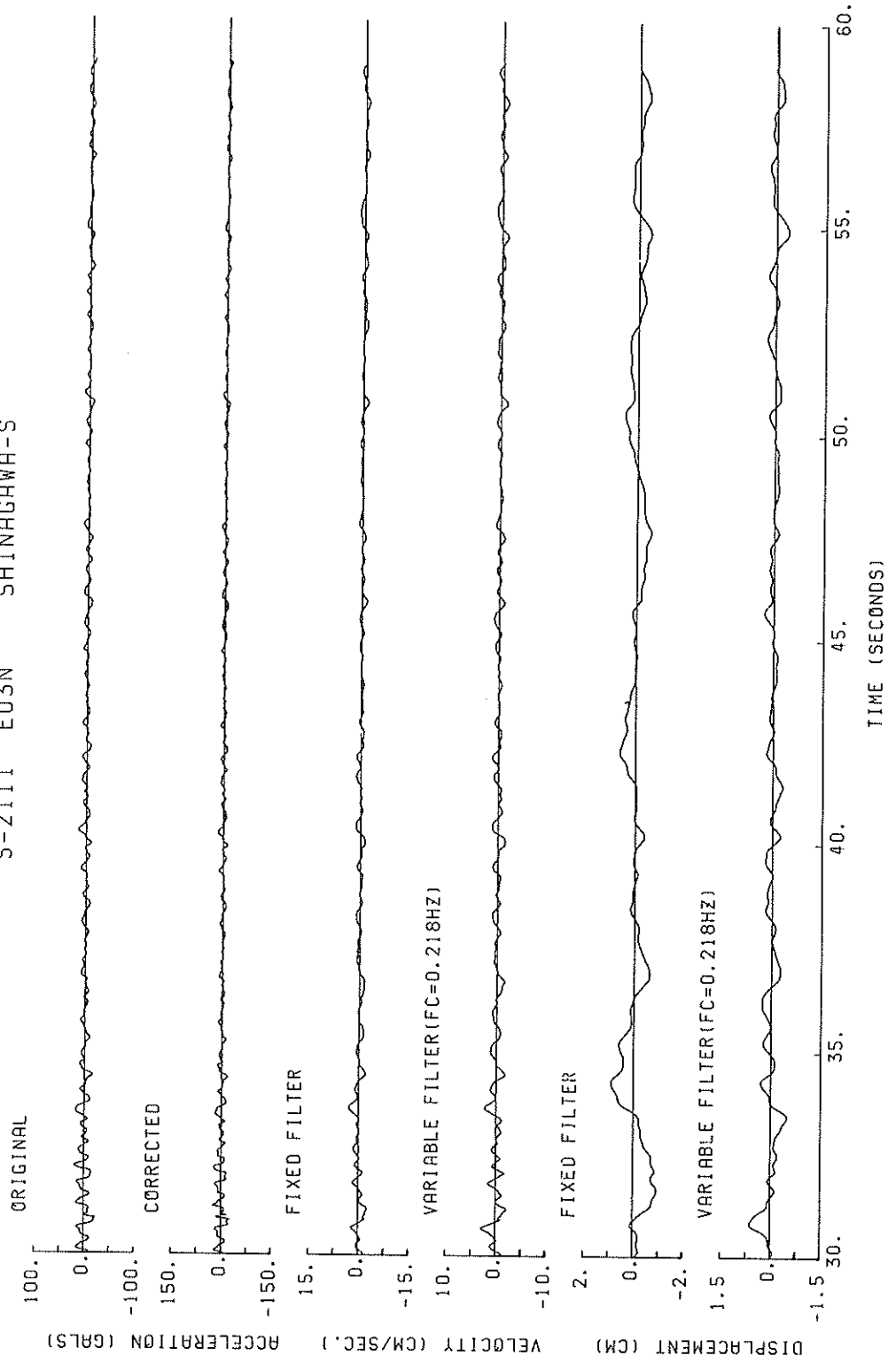

S-2111 DOWN SHINAGAWA-S

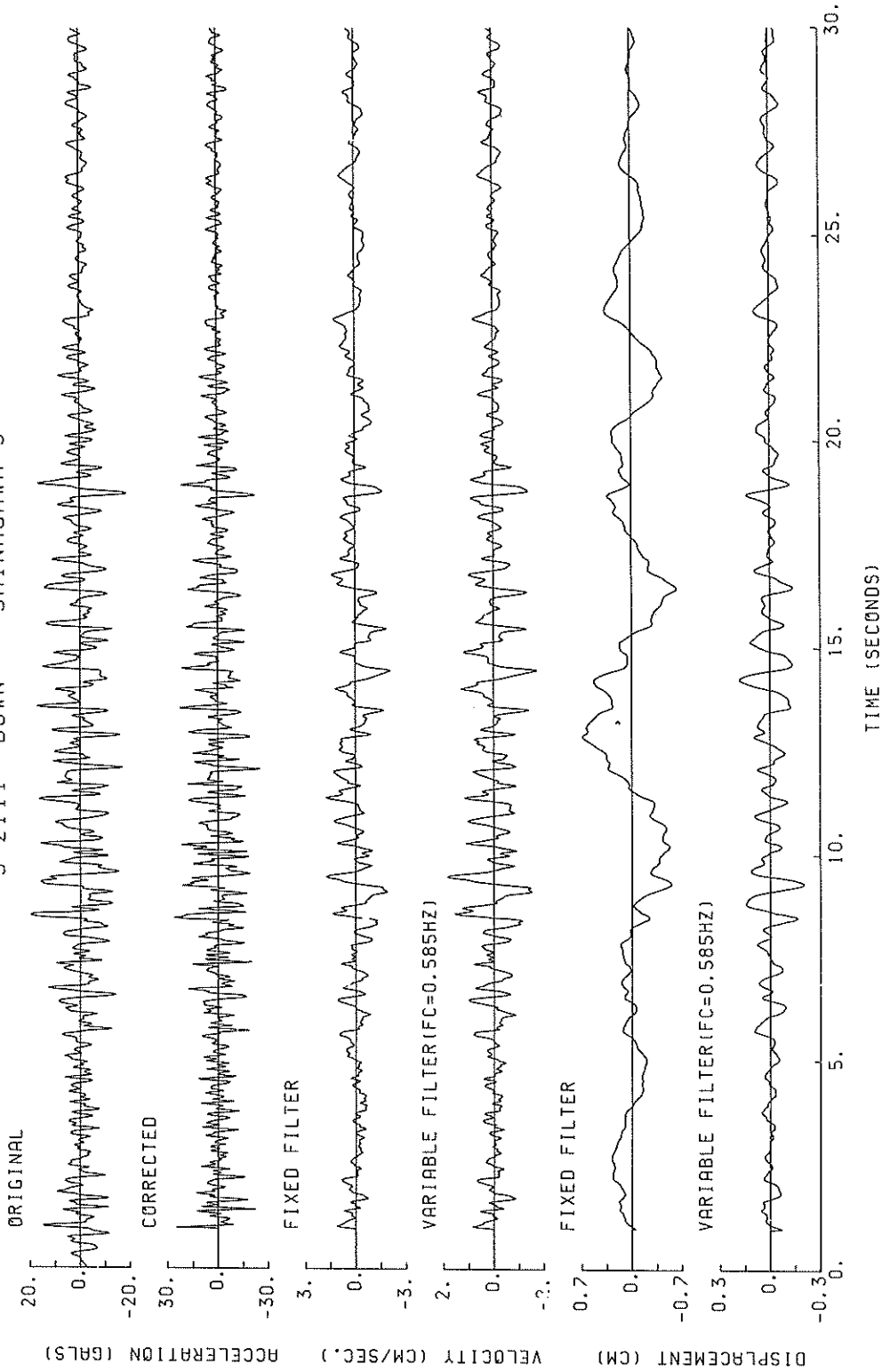

S-2111 DOWN SHINAGAWA-S

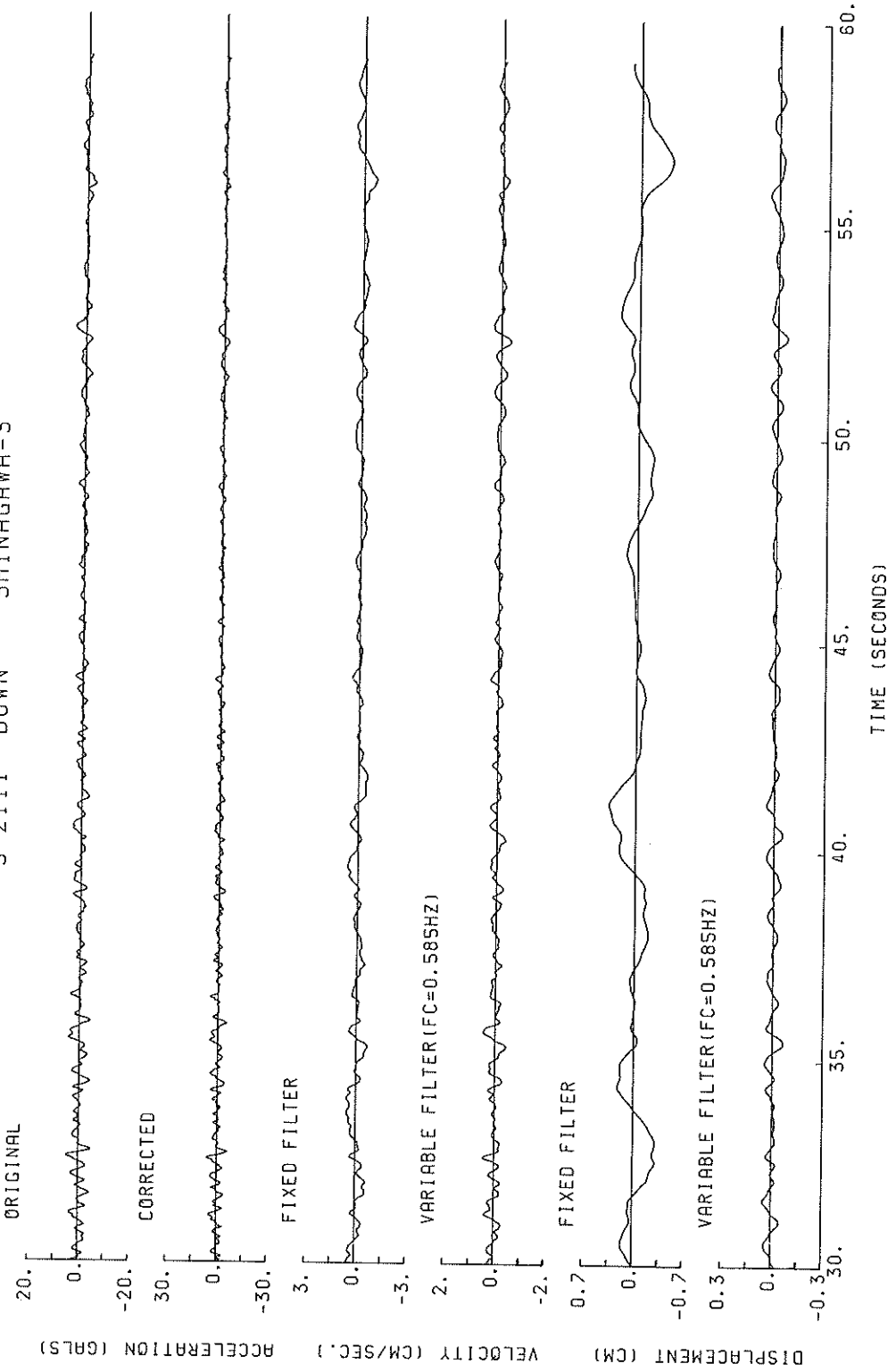

S-2111 E03N SHINAGAWA-S
(1/FC=4.58 SEC.)

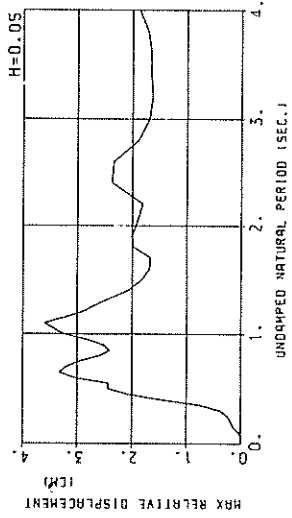
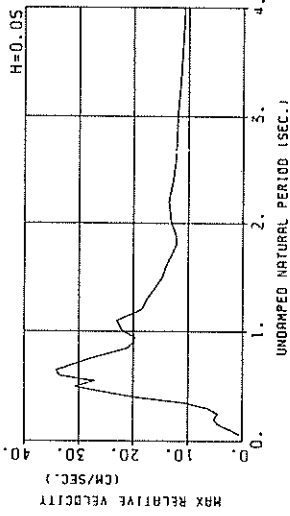
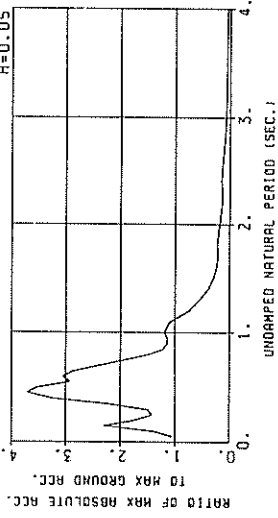

RESPONSE SPECTRA

S-2111 S03E SHINAGAWA-S
(1/FC=3.91 SEC.)

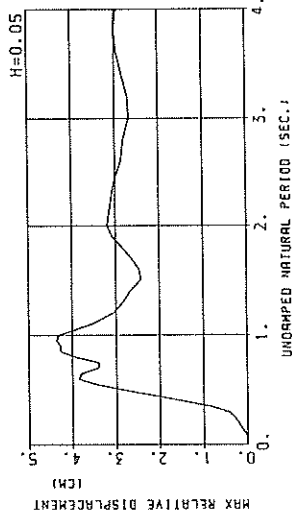
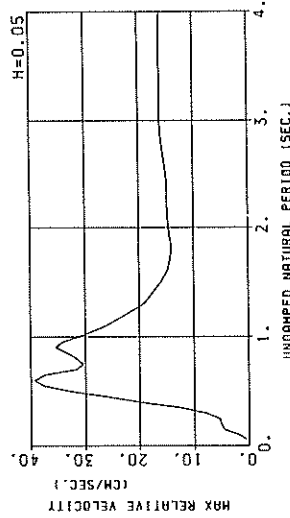
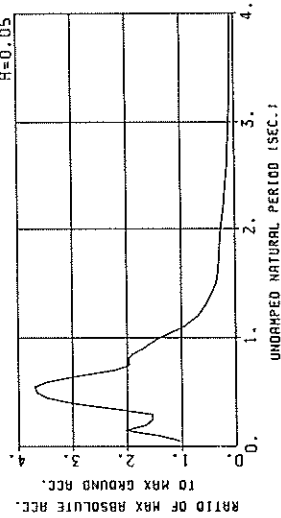

RESPONSE SPECTRA

S-2111 DOWN SHINAGAWA-S
(1/FG=1.71 SEC.)

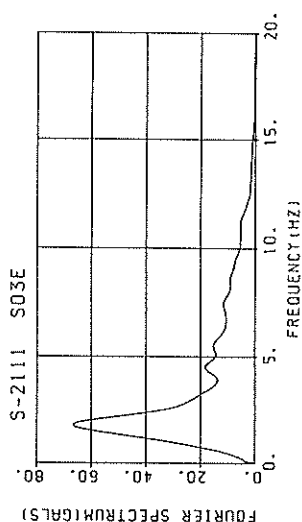
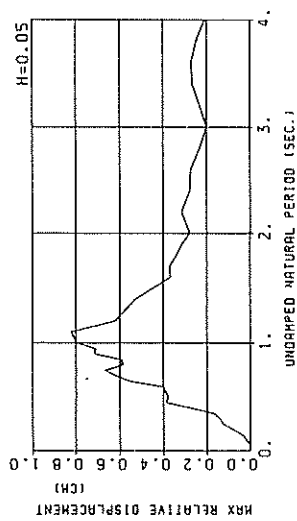
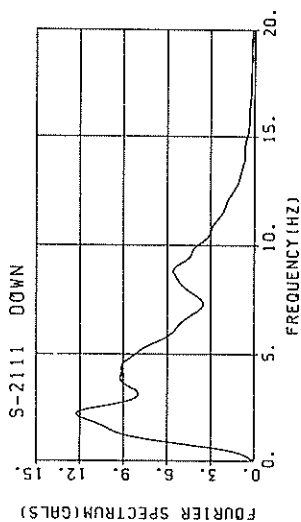
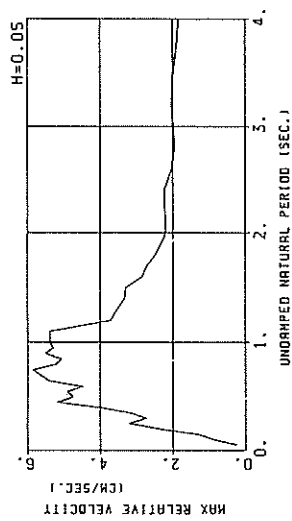
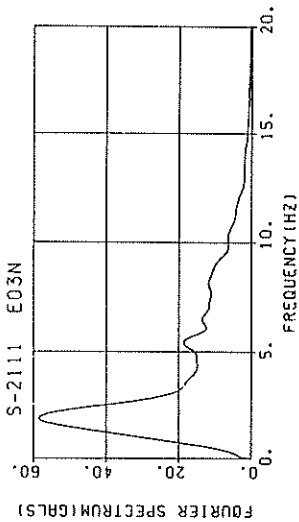
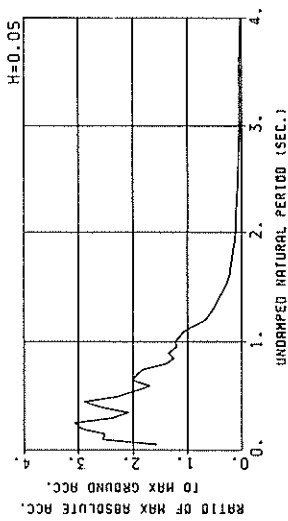

RESPONSE SPECTRA

FOURIER SPECTRA

RESPONSE SPECTRUM

RECORD = S-2111 COMPONENT = SO3E SIGNAL = GR. ACC. CORRECTION = STATION = SHINAGAWA-S
 DATE AND TIME = 1987-12-17-11-08 SAMPLING INTERVAL = 0.0100(SEC) MAX. GROUND ACC. = 122.92 (GAL)
 TIME LENGTH = 58.99 (SEC) SKIPPED LENGTH = 0.00 (SEC)

PER	DAMPING = 0.				DAMPING = 0.025				DAMPING = 0.050				DAMPING = 0.100				DAMPING = 0.250			
	AA	RV	RD	AA	RV	RD	AA	RV	RD	AA	RV	RD	AA	RV	RD	AA	RV	RD		
0.05	152.5	0.67	0.010	128.5	0.20	0.008	126.6	0.19	0.008	125.4	0.19	0.008	125.0	0.18	0.008	125.0	0.18	0.008		
0.10	402.3	6.23	0.102	193.5	2.15	0.049	172.9	1.73	0.044	156.2	1.32	0.039	135.2	0.85	0.033	135.2	0.85	0.033		
0.15	568.8	12.90	0.324	295.0	6.08	0.158	250.4	4.52	0.142	200.9	2.95	0.114	150.6	1.72	0.082	150.6	1.72	0.082		
0.20	383.5	12.14	0.389	221.5	5.84	0.224	203.7	4.52	0.206	192.4	4.45	0.195	150.4	2.58	0.142	150.4	2.58	0.142		
0.25	273.6	10.08	0.433	223.6	6.32	0.353	188.3	5.41	0.298	165.1	4.68	0.258	141.9	3.26	0.206	141.9	3.26	0.206		
0.30	508.5	20.02	1.159	220.5	10.19	0.503	188.7	7.71	0.429	179.2	6.32	0.404	140.3	4.79	0.304	140.3	4.79	0.304		
0.35	912.2	50.07	2.831	306.6	14.34	0.949	277.1	12.28	0.856	232.2	10.21	0.711	158.7	6.45	0.466	158.7	6.45	0.466		
0.40	797.9	50.37	3.234	425.4	22.67	1.722	367.5	19.39	1.475	285.9	15.04	1.145	185.8	9.01	0.720	185.8	9.01	0.720		
0.45	308.5	56.75	4.147	505.2	31.91	2.593	427.9	25.85	2.189	331.2	19.64	1.676	207.6	11.07	1.003	207.6	11.07	1.003		
0.50	938.7	75.08	5.944	549.3	41.94	3.474	450.6	32.53	2.844	338.5	24.38	2.097	215.4	13.78	1.243	215.4	13.78	1.243		
0.55	1292.3	113.27	9.902	567.6	47.96	4.346	455.6	37.60	3.476	322.2	28.28	2.425	204.0	15.95	1.415	204.0	15.95	1.415		
0.60	850.7	82.86	7.757	536.6	49.21	4.884	424.5	39.32	3.852	300.0	29.88	2.683	188.9	16.98	1.559	188.9	16.98	1.559		
0.65	854.4	88.45	9.144	444.2	45.72	4.749	355.5	37.46	3.786	264.4	28.37	2.771	179.3	17.30	1.718	179.3	17.30	1.718		
0.70	662.4	73.93	8.221	344.2	39.47	4.268	275.0	31.52	3.398	233.2	26.34	2.831	168.3	17.39	1.838	168.3	17.39	1.838		
0.75	685.5	82.32	9.767	293.5	37.14	4.179	240.0	30.42	3.398	215.9	25.60	2.998	155.8	17.40	1.942	155.8	17.40	1.942		
0.80	388.9	50.07	6.305	272.5	36.36	4.414	244.5	31.62	3.935	205.5	25.69	3.237	145.5	17.51	2.092	145.5	17.51	2.092		
0.85	299.7	41.89	5.485	266.0	36.60	4.862	234.7	33.23	4.268	189.3	27.73	3.357	139.4	17.95	2.231	139.4	17.95	2.231		
0.90	259.6	46.94	6.148	245.6	40.04	5.029	209.6	35.34	4.273	173.4	28.74	3.452	132.5	18.29	2.337	132.5	18.29	2.337		
0.95	234.6	42.58	5.364	212.3	38.28	4.843	191.8	34.32	4.354	162.4	28.20	3.594	124.6	18.28	2.400	124.6	18.28	2.400		
1.00	226.7	39.93	5.743	191.4	34.80	4.841	171.2	31.24	4.306	145.5	26.24	3.562	115.6	17.91	2.417	115.6	17.91	2.417		
1.10	255.2	43.61	7.823	153.4	29.30	4.696	116.6	26.07	3.547	106.2	23.16	3.140	96.6	17.80	2.346	96.6	17.80	2.346		
1.20	249.2	47.96	9.089	103.6	23.74	3.775	83.9	22.55	3.044	74.9	20.66	2.626	79.8	17.10	2.212	74.9	17.10	2.212		
1.30	78.9	18.29	3.292	72.4	18.99	3.092	66.1	19.09	2.814	54.8	18.51	2.282	66.4	16.25	2.081	66.4	16.25	2.081		
1.40	68.4	18.46	3.394	59.9	17.82	2.965	54.1	17.51	2.660	45.6	17.00	2.196	56.6	15.44	1.983	56.6	15.44	1.983		
1.50	97.8	23.50	5.572	43.9	15.87	2.495	42.8	15.93	2.412	40.1	15.83	2.214	49.5	14.79	1.925	49.5	14.79	1.925		
1.60	45.5	15.69	2.948	39.0	14.49	2.523	38.5	14.76	2.468	37.0	14.96	2.311	44.2	14.35	1.902	44.2	14.35	1.902		
1.70	42.1	14.31	3.083	37.6	14.09	2.741	36.6	14.27	2.624	34.9	14.67	2.448	40.3	14.10	1.907	40.3	14.10	1.907		
1.80	47.5	14.40	3.896	36.5	13.88	2.989	35.3	14.00	2.873	33.5	14.27	2.598	37.3	13.96	1.985	37.3	13.96	1.985		
1.90	49.0	18.10	4.478	36.1	14.93	3.290	34.1	14.25	3.073	31.5	14.29	2.728	34.8	13.90	2.044	34.8	13.90	2.044		
2.00	43.1	16.95	4.366	34.0	14.78	3.442	31.8	14.62	3.185	29.4	14.42	2.801	33.6	13.89	2.080	33.6	13.89	2.080		
2.20	33.7	15.17	4.134	29.2	14.99	3.563	25.5	14.85	3.101	24.2	14.61	2.783	29.1	13.97	2.080	29.1	13.97	2.080		
2.40	44.0	16.98	6.414	23.5	14.80	3.416	21.0	14.83	3.027	19.6	14.75	2.685	26.2	14.11	2.135	26.2	14.11	2.135		
2.60	26.8	15.69	5.596	19.4	15.32	3.312	16.8	15.37	2.851	16.7	15.09	2.557	23.7	14.29	2.175	23.7	14.29	2.175		
2.80	28.2	16.82	5.604	17.9	16.42	3.548	14.4	15.91	2.796	14.7	15.44	2.581	21.6	14.47	2.182	21.6	14.47	2.182		
3.00	22.6	16.69	5.152	12.8	16.38	2.905	12.0	16.10	2.667	12.0	15.63	2.516	19.6	14.62	2.162	19.6	14.62	2.162		
3.20	12.9	16.45	3.359	11.1	16.27	2.848	10.6	16.08	2.694	11.7	15.69	2.418	17.9	14.73	2.117	17.9	14.73	2.117		
3.40	10.7	16.38	3.135	10.3	16.24	2.982	9.9	16.08	2.828	9.5	15.73	2.538	16.4	14.80	2.054	16.4	14.80	2.054		
3.60	10.1	16.50	3.321	9.6	16.31	3.123	9.3	16.12	2.944	8.8	15.75	2.630	15.0	14.84	1.975	15.0	14.84	1.975		
3.80	9.4	16.62	3.424	8.8	16.37	3.193	8.5	16.14	2.994	8.1	15.74	2.666	13.8	14.84	2.002	13.8	14.84	2.002		
4.00	8.3	16.58	3.359	7.8	16.31	3.133	7.6	16.07	2.943	7.4	15.68	2.635	12.7	14.82	2.022	12.7	14.82	2.022		

PER = PERIOD (SEC) AA = ABSOLUTE ACC. (GAL) RV = RELATIVE VELOCITY (CM/SEC) RD = RELATIVE DISPLACEMENT (CM)

RESPONSE SPECTRUM

RECORD = S-2111 COMPONENT = ED3N SIGNAL = GR. ACC. CORRECTION = STATION = SHINAGAWA-S
 DATE AND TIME = 1987-12-17-11-08 SAMPLING INTERVAL = 0.0100(SEC) MAX.GROUND ACC. = 109.21 (GAL)
 TIME LENGTH = 58.99 (SEC) SKIPPED LENGTH = 0.00 (SEC)

PER	DAMPING = 0.				DAMPING = 0.025				DAMPING = 0.050				DAMPING = 0.100				DAMPING = 0.250			
	AA	RV	RD	AA	RV	RD	AA	RV	RD	AA	RV	RD	AA	RV	RD	AA	RV	RD		
0.05	142.9	0.45	0.009	112.5	0.21	0.007	113.0	0.20	0.007	113.2	0.18	0.007	113.5	0.17	0.007	113.5	0.17	0.007		
0.10	600.1	9.46	0.152	175.0	2.36	0.044	150.5	2.03	0.038	141.5	1.55	0.036	131.4	0.81	0.033	131.4	0.81	0.033		
0.15	923.4	21.70	0.526	299.4	5.79	0.170	250.4	4.49	0.141	192.7	2.97	0.109	136.9	1.75	0.074	136.9	1.75	0.074		
0.20	754.5	23.90	0.764	220.4	6.18	0.223	193.3	5.23	0.195	150.9	4.00	0.150	113.0	2.28	0.109	113.0	2.28	0.109		
0.25	644.6	25.13	1.020	175.5	6.52	0.278	154.7	4.57	0.245	132.2	3.95	0.208	120.5	2.99	0.186	120.5	2.99	0.186		
0.30	434.3	19.85	0.990	198.1	8.07	0.452	163.7	6.29	0.373	136.5	5.09	0.310	135.8	3.90	0.298	135.8	3.90	0.298		
0.35	370.0	19.26	1.148	258.9	12.51	0.804	243.5	10.78	0.754	211.0	9.05	0.647	161.4	5.80	0.472	161.4	5.80	0.472		
0.40	782.5	48.44	3.171	442.0	24.38	1.793	355.2	19.39	1.435	270.2	14.51	1.080	177.6	8.72	0.667	177.6	8.72	0.667		
0.45	1484.1	105.99	7.612	492.3	34.66	2.527	405.0	25.75	2.068	308.2	19.70	1.554	180.5	11.09	0.848	180.5	11.09	0.848		
0.50	882.6	69.95	5.589	479.1	37.21	3.026	386.4	30.81	2.435	294.4	22.31	1.832	175.0	12.27	1.016	175.0	12.27	1.016		
0.55	752.6	65.26	5.767	381.9	32.03	2.924	318.8	27.19	2.432	252.1	20.87	1.896	163.4	12.52	1.147	163.4	12.52	1.147		
0.60	693.6	66.93	6.325	450.4	43.76	4.107	333.7	33.63	3.028	222.9	22.31	1.992	151.0	12.42	1.245	151.0	12.42	1.245		
0.65	1124.6	116.22	12.014	401.8	42.92	4.296	312.9	34.20	3.331	222.3	23.50	2.329	138.2	12.28	1.308	138.2	12.28	1.308		
0.70	484.0	55.99	6.007	305.6	36.31	3.790	259.4	31.04	3.203	188.9	23.61	2.300	126.5	12.84	1.366	126.5	12.84	1.366		
0.75	591.7	70.62	8.430	261.8	34.01	3.727	210.5	28.19	2.982	154.5	21.21	2.154	116.5	12.52	1.417	116.5	12.52	1.417		
0.80	233.6	33.33	4.112	192.0	28.39	3.106	161.2	24.42	2.591	128.5	18.77	2.022	107.4	12.44	1.460	107.4	12.44	1.460		
0.85	437.9	59.48	8.014	159.0	23.19	2.905	132.7	21.16	2.414	117.4	17.29	2.089	98.6	12.73	1.491	98.6	12.73	1.491		
0.90	239.5	35.64	4.915	136.3	22.39	2.794	123.9	19.92	2.528	109.7	16.70	2.197	90.3	13.09	1.509	90.3	13.09	1.509		
0.95	250.9	39.48	5.737	143.4	22.84	3.274	123.5	19.83	2.809	104.6	17.90	2.341	81.9	13.45	1.512	81.9	13.45	1.512		
1.00	283.9	44.69	7.191	160.9	27.92	4.222	129.5	21.97	3.261	98.5	19.84	2.431	74.2	13.75	1.546	74.2	13.75	1.546		
1.10	296.8	53.63	9.096	161.7	31.00	4.949	118.4	23.10	3.604	82.8	19.44	2.442	68.9	13.86	1.693	68.9	13.86	1.693		
1.20	167.5	33.43	6.111	110.7	22.42	4.031	80.6	18.48	2.913	69.9	17.04	2.444	61.8	13.35	1.748	61.8	13.35	1.748		
1.30	83.9	20.22	3.592	64.3	18.62	2.747	59.6	17.47	2.525	55.1	15.72	2.249	54.1	12.51	1.732	54.1	12.51	1.732		
1.40	46.9	17.17	2.328	43.1	16.84	2.130	42.2	16.08	2.067	42.4	15.04	1.992	46.9	12.51	1.679	46.9	12.51	1.679		
1.50	36.0	14.39	2.050	33.3	14.69	1.891	32.4	14.85	1.817	33.6	14.21	1.796	40.9	12.45	1.618	40.9	12.45	1.618		
1.60	31.4	12.88	2.039	26.5	14.43	1.713	26.3	14.04	1.677	27.6	13.56	1.662	36.1	12.32	1.566	36.1	12.32	1.566		
1.70	27.3	12.88	2.001	25.4	12.93	1.855	23.0	12.98	1.677	23.3	12.93	1.565	32.4	12.18	1.526	32.4	12.18	1.526		
1.80	76.8	22.16	6.301	30.1	11.59	2.460	24.6	12.11	1.985	21.0	12.50	1.569	29.4	12.07	1.499	29.4	12.07	1.499		
1.90	43.4	15.49	3.966	28.0	12.07	2.558	22.1	12.33	2.008	19.9	12.49	1.651	26.9	12.01	1.478	26.9	12.01	1.478		
2.00	42.7	15.11	4.331	22.3	13.41	2.258	19.5	13.11	1.929	18.6	12.74	1.702	24.8	11.99	1.455	24.8	11.99	1.455		
2.20	21.3	14.65	2.616	17.2	14.04	2.105	14.9	13.58	1.806	14.5	12.96	1.641	21.1	11.95	1.388	21.1	11.95	1.388		
2.40	28.8	12.78	4.208	18.5	12.83	2.691	16.7	12.78	2.373	14.7	12.59	1.958	18.2	11.85	1.325	18.2	11.85	1.325		
2.60	24.0	12.29	4.103	15.3	12.33	2.599	14.0	12.32	2.343	12.9	12.24	1.968	15.8	11.72	1.402	15.8	11.72	1.402		
2.80	12.3	12.38	2.445	10.5	12.26	2.073	9.8	12.17	1.883	9.9	12.02	1.704	14.0	11.58	1.402	14.0	11.58	1.402		
3.00	9.7	12.14	2.204	8.4	12.03	1.911	7.5	11.94	1.687	7.6	11.80	1.482	12.4	11.44	1.352	12.4	11.44	1.352		
3.20	11.7	11.69	3.032	6.6	11.67	1.691	6.6	11.64	1.631	7.0	11.55	1.533	11.2	11.30	1.323	11.2	11.30	1.323		
3.40	8.3	11.31	2.442	5.9	11.33	1.702	6.0	11.34	1.652	6.4	11.32	1.561	10.2	11.17	1.349	10.2	11.17	1.349		
3.60	6.3	11.05	2.058	5.3	11.08	1.700	5.4	11.10	1.656	5.9	11.10	1.573	9.4	11.03	1.367	9.4	11.03	1.367		
3.80	11.0	10.85	4.023	5.5	10.87	2.015	4.9	10.89	1.708	5.4	10.91	1.576	8.7	10.91	1.375	8.7	10.91	1.375		
4.00	9.3	10.65	3.768	5.1	10.67	2.059	4.9	10.70	1.869	5.1	10.74	1.643	8.1	10.79	1.376	8.1	10.79	1.376		

PER = PERIOD (SEC) AA = ABSOLUTE ACC. (GAL) RV = RELATIVE VELOCITY (CM/SEC) RD = RELATIVE DISPLACEMENT (CM)

RESPONSE SPECTRUM

RECORD = S-2111
 DATE AND TIME = 1987-12-17-11-08
 TIME LENGTH = 58.99 (SEC)

COMPONENT = DOWN
 SIGNAL = GR. ACC.
 SAMPRING INTERVAL = 0.0100(SEC)
 SKIPPED LENGTH = 0.00 (SEC)

CORRECTION =
 MAX.GROUND ACC. = 26.01 (GAL)
 STATION = SHINAGAWA-S

PER	DAMPING = 0.			DAMPING = 0.025			DAMPING = 0.050			DAMPING = 0.100			DAMPING = 0.250		
	AA	RV	RD	AA	RV	RD	AA	RV	RD	AA	RV	RD	AA	RV	RD
0.05	54.9	0.28	0.003	41.5	0.24	0.003	40.0	0.22	0.003	37.4	0.18	0.002	32.6	0.13	0.002
0.10	168.9	2.64	0.043	83.8	1.52	0.021	66.3	0.85	0.017	51.9	0.63	0.013	39.8	0.41	0.010
0.15	227.2	5.27	0.150	94.1	1.96	0.034	65.3	1.29	0.037	49.3	0.93	0.028	36.9	0.61	0.020
0.20	401.4	12.73	0.407	109.6	3.82	0.111	78.5	2.33	0.077	58.2	1.61	0.056	38.4	0.91	0.036
0.25	305.7	12.14	0.484	108.9	4.35	0.172	80.0	3.19	0.125	55.9	2.28	0.086	35.5	1.17	0.051
0.30	121.4	5.92	0.277	69.7	3.16	0.159	61.7	2.73	0.140	49.0	2.28	0.109	31.6	1.37	0.064
0.35	277.3	15.40	0.860	69.8	3.96	0.215	54.2	3.16	0.168	42.2	2.49	0.130	33.2	1.68	0.097
0.40	158.3	9.98	0.642	76.5	4.51	0.310	66.4	3.95	0.267	51.3	3.21	0.205	36.0	1.84	0.132
0.45	342.6	24.50	1.758	107.7	7.41	0.552	75.3	5.19	0.385	52.0	3.53	0.262	34.4	1.85	0.155
0.50	165.4	12.98	1.035	81.9	6.55	0.517	59.4	4.76	0.375	45.5	3.58	0.270	30.2	2.07	0.162
0.55	202.6	17.74	1.553	67.5	6.04	0.517	51.2	4.91	0.390	36.4	3.59	0.271	26.2	2.16	0.179
0.60	93.5	9.34	0.852	57.0	5.57	0.518	43.7	4.48	0.397	35.7	3.49	0.321	25.3	2.42	0.212
0.65	201.4	20.81	2.156	67.1	7.19	0.718	52.1	5.43	0.554	40.8	4.05	0.428	25.5	2.66	0.243
0.70	78.2	9.47	0.970	57.7	7.41	0.715	50.2	5.65	0.620	40.0	4.45	0.483	24.7	2.80	0.274
0.75	132.8	15.85	1.892	58.0	7.46	0.825	47.0	5.86	0.666	35.7	4.58	0.495	24.3	2.83	0.310
0.80	104.6	13.29	1.696	41.3	5.53	0.668	36.3	5.22	0.584	32.0	4.37	0.506	23.8	2.80	0.337
0.85	71.9	9.92	1.318	39.1	5.79	0.714	32.6	5.07	0.594	29.3	4.31	0.520	22.7	2.71	0.355
0.90	126.7	18.12	2.600	50.7	7.67	1.038	35.1	5.51	0.716	27.3	4.27	0.543	21.4	2.67	0.367
0.95	50.8	8.64	1.162	35.8	6.36	0.816	31.4	5.30	0.711	26.4	4.23	0.584	19.8	2.73	0.371
1.00	60.0	9.66	1.521	37.5	6.69	0.949	31.8	5.39	0.798	24.7	4.18	0.603	18.1	2.73	0.367
1.10	46.2	8.72	1.415	33.6	6.34	1.028	27.1	5.39	0.823	19.2	4.29	0.567	14.4	2.82	0.339
1.20	22.9	5.26	0.834	19.2	4.25	0.699	17.1	3.70	0.619	15.1	3.45	0.525	12.3	2.77	0.335
1.30	20.9	4.89	0.895	15.0	3.95	0.640	13.5	3.53	0.572	12.1	2.95	0.493	10.9	2.65	0.350
1.40	15.6	4.47	0.774	11.8	3.47	0.584	10.7	3.33	0.526	9.4	2.91	0.448	9.5	2.54	0.331
1.50	20.5	5.00	1.168	9.5	3.63	0.538	7.9	3.29	0.445	6.9	2.88	0.379	8.1	2.44	0.307
1.60	10.3	2.97	0.666	6.1	2.80	0.395	5.7	2.84	0.365	5.4	2.70	0.342	6.9	2.36	0.281
1.70	6.9	3.09	0.504	5.6	2.85	0.410	5.1	2.72	0.370	4.7	2.56	0.341	6.0	2.28	0.261
1.80	3.8	2.37	0.313	4.2	2.47	0.341	4.2	2.48	0.358	4.0	2.42	0.345	5.2	2.22	0.252
1.90	4.2	2.44	0.381	3.7	2.35	0.332	3.5	2.35	0.314	3.5	2.30	0.297	4.6	2.18	0.248
2.00	3.6	2.20	0.362	2.6	2.11	0.261	2.8	2.19	0.277	3.0	2.21	0.282	4.1	2.14	0.248
2.20	3.6	2.60	0.438	2.9	2.33	0.353	2.6	2.21	0.313	2.5	2.13	0.279	3.4	2.10	0.238
2.40	3.1	2.42	0.433	2.1	2.30	0.304	2.0	2.22	0.276	2.1	2.14	0.252	3.0	2.07	0.231
2.60	1.9	2.08	0.320	1.7	1.99	0.292	1.7	2.02	0.272	1.8	2.05	0.250	2.6	2.05	0.230
2.80	1.9	1.82	0.362	1.3	1.88	0.249	1.2	1.94	0.232	1.5	1.99	0.228	2.4	2.02	0.228
3.00	1.0	2.00	0.236	1.0	1.99	0.212	1.0	1.99	0.200	1.3	2.00	0.219	2.2	2.00	0.226
3.20	1.0	2.13	0.268	1.0	2.08	0.238	1.0	2.04	0.232	1.3	2.01	0.231	2.0	1.99	0.226
3.40	1.1	2.07	0.312	1.0	2.04	0.284	1.0	2.01	0.265	1.2	1.99	0.244	1.8	1.97	0.225
3.60	1.0	1.92	0.320	0.9	1.93	0.290	0.9	1.94	0.270	1.1	1.95	0.246	1.7	1.96	0.223
3.80	0.7	1.79	0.270	0.7	1.84	0.256	0.8	1.87	0.246	1.0	1.91	0.233	1.6	1.94	0.220
4.00	0.6	1.80	0.263	0.6	1.80	0.218	0.6	1.83	0.208	0.8	1.88	0.212	1.5	1.93	0.216

PER = PERIOD (SEC) AA = ABSOLUTE ACC. (GAL) RV = RELATIVE VELOCITY (CM/SEC) RD = RELATIVE DISPLACEMENT (CM)

S-2111 SHINAGAWA-S

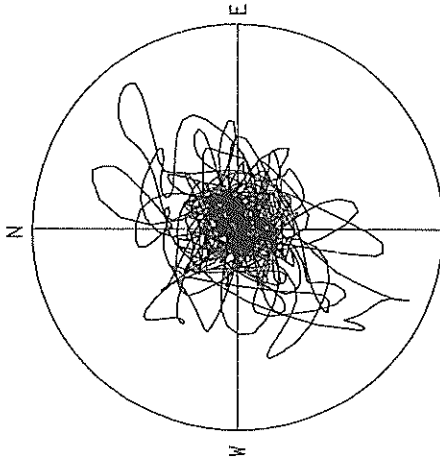

ACCELERATION
R=150.0GAL
MAX=135.7GAL

S-2111 SHINAGAWA-S

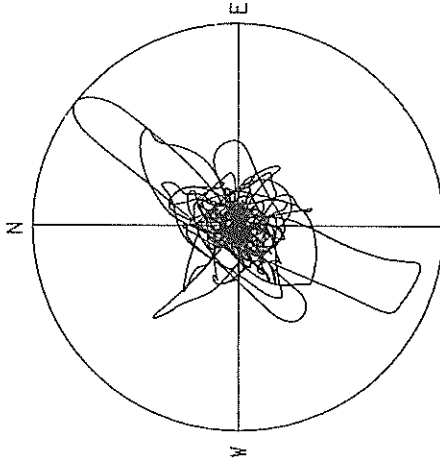

VELOCITY
R=15.0 CM/SEC.
MAX=15.0 CM/SEC.

S-2111 SHINAGAWA-S

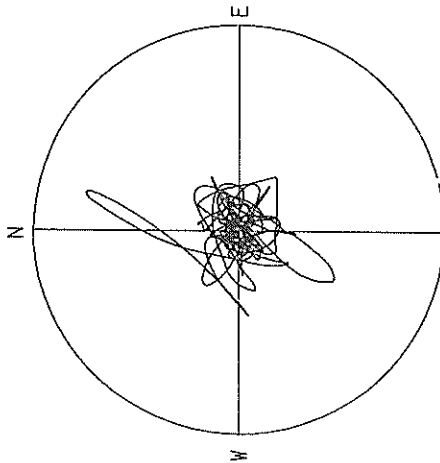

DISPLACEMENT
R=3.00 CM
MAX=2.30 CM

RECORD NUMBER
STATION

S-2112

KEIHIN-JI-S

EARTHQUAKE DATA

DATA AND TIME *****
LOCATION OF HYPOCENTER *****
EPCENTRAL REGION *****
LATITUDE *****
LONGITUDE *****
DEPTH *****
MAGNITUDE *****

11: 8 DEC.17,1987

CHIBA-KEN-TOHO-OKI

35°22' N

140°30' E

58KM

6.7

PEAK VALUES OF COMPONENTS

N S E W U D HORIZONTAL*

PARAMETER OF THE VARIABLE FILTER

FC (HZ) 0.157 0.183 0.231

MAXIMUM ACCELERATION (GAL)

ORIGINAL 59.9 47.6 24.4 60.4
CORRECTED 63.5 55.6 26.6 63.6

MAXIMUM VELOCITY (CM/SEC)

FIXED FILTER 6.56 6.01 2.52 7.25
VARIABLE FILTER 5.74 5.93 2.12 6.94

MAXIMUM DISPLACEMENT (CM)

FIXED FILTER 2.308 2.042 1.760 3.005
VARIABLE FILTER 1.930 2.104 0.460 2.661

* RESULTANT OF HORIZONTAL COMPONENTS

S-2112 KEIHIN-JI-S

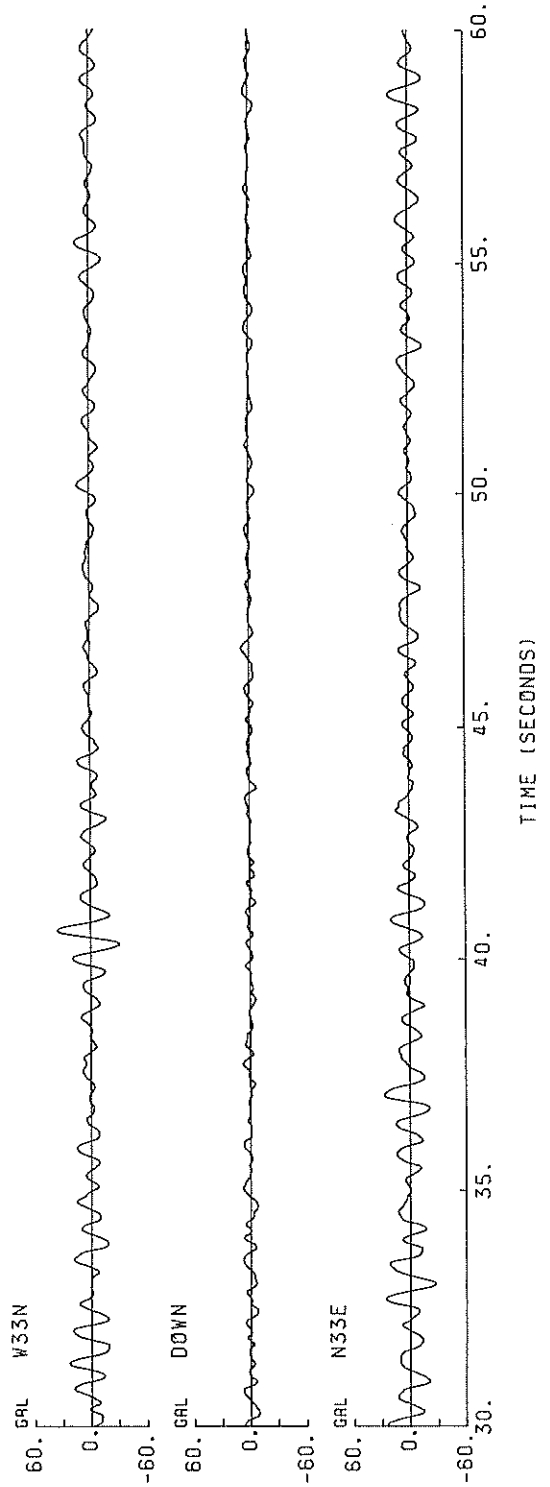
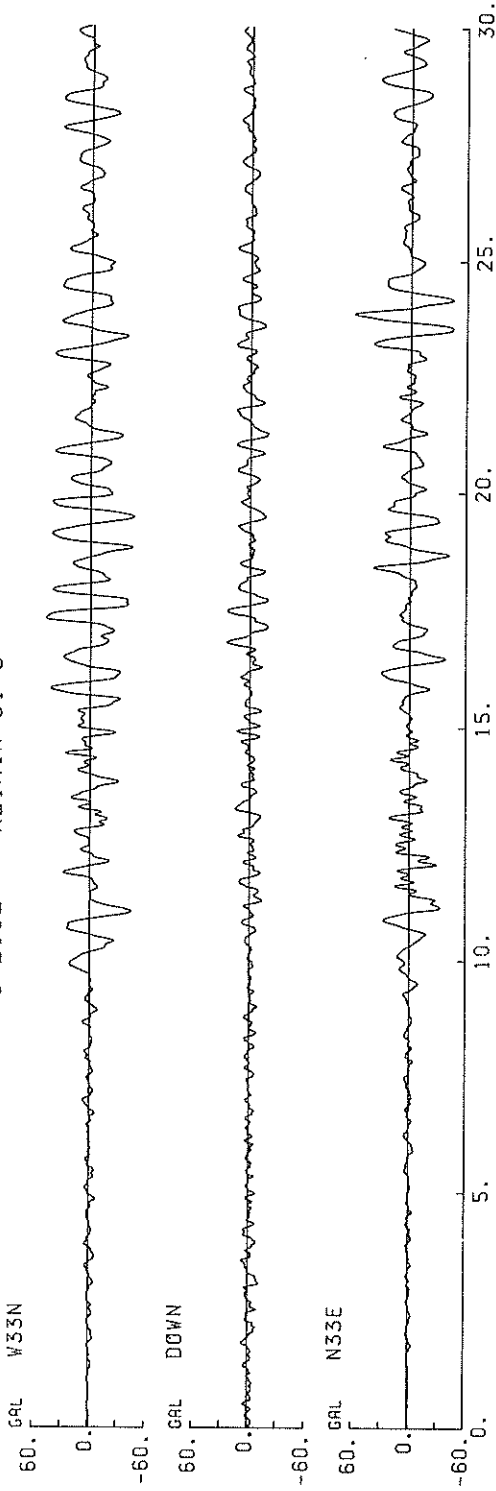

S-2112 N35E KEIHIN-JI-S

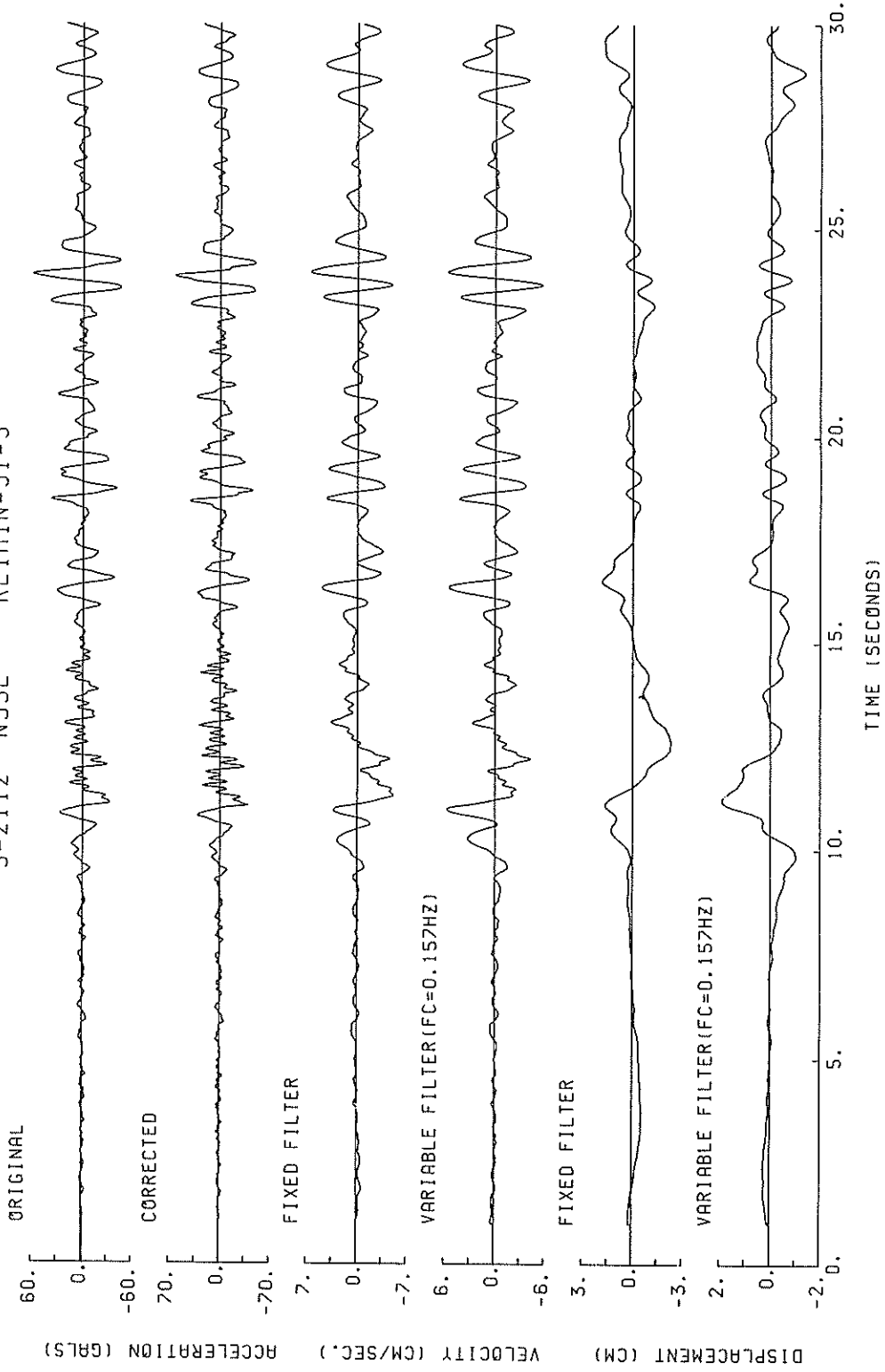

S-2112 N33E KEIHIN-JI-S

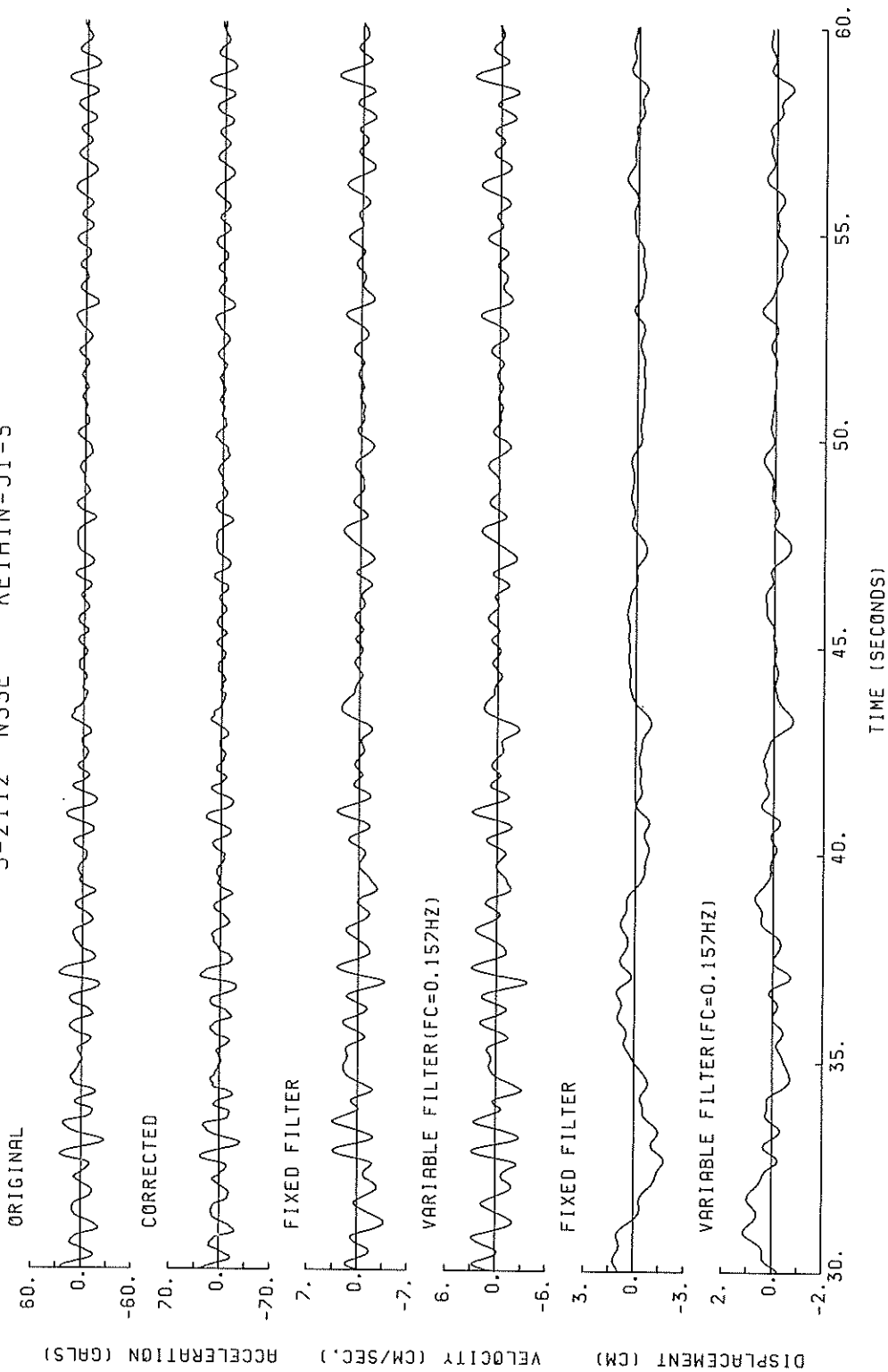

S-2112 W33N KEIHIN-JI-S

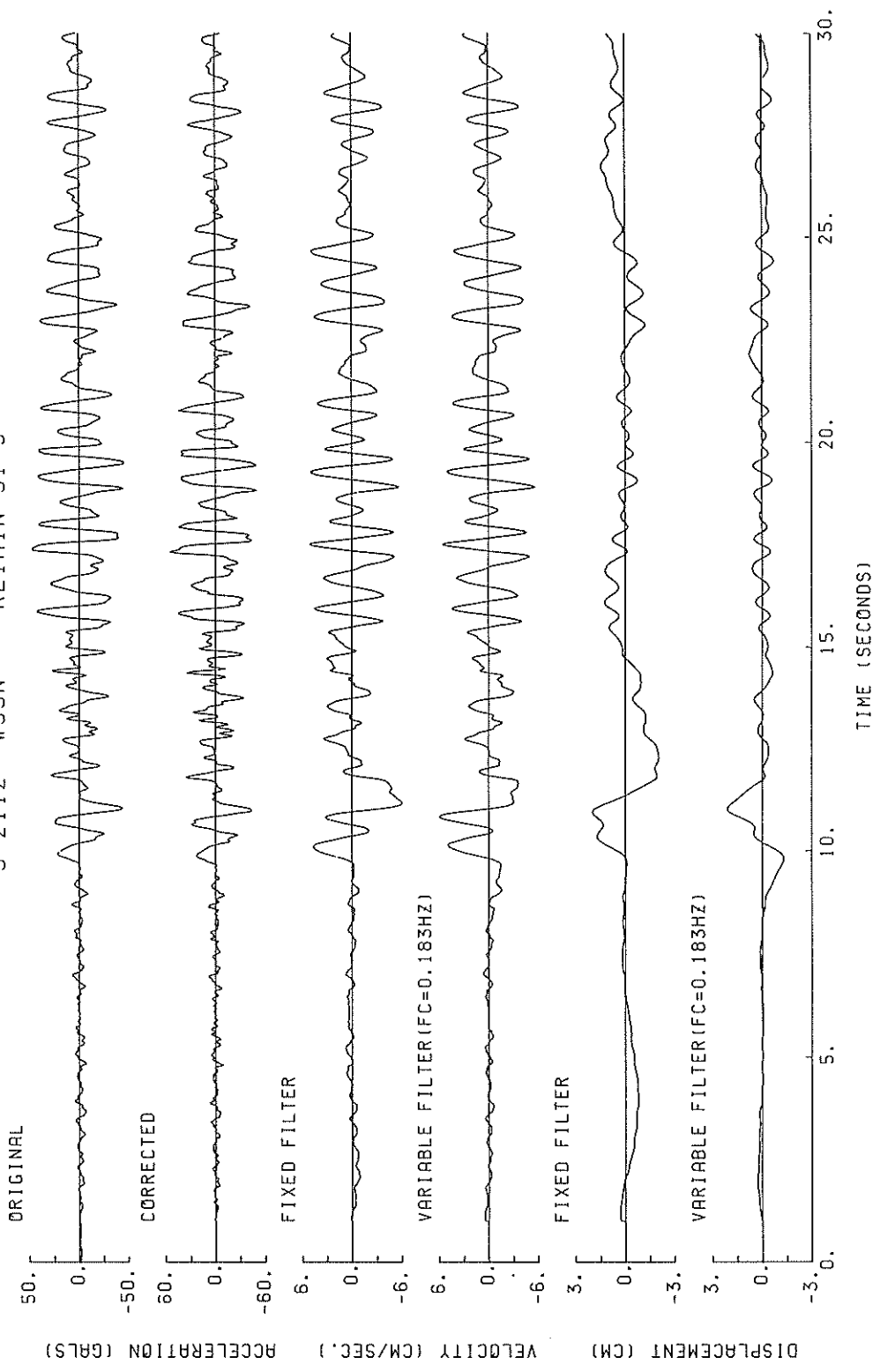

S-2112 W33N KEIHIN-JI-S

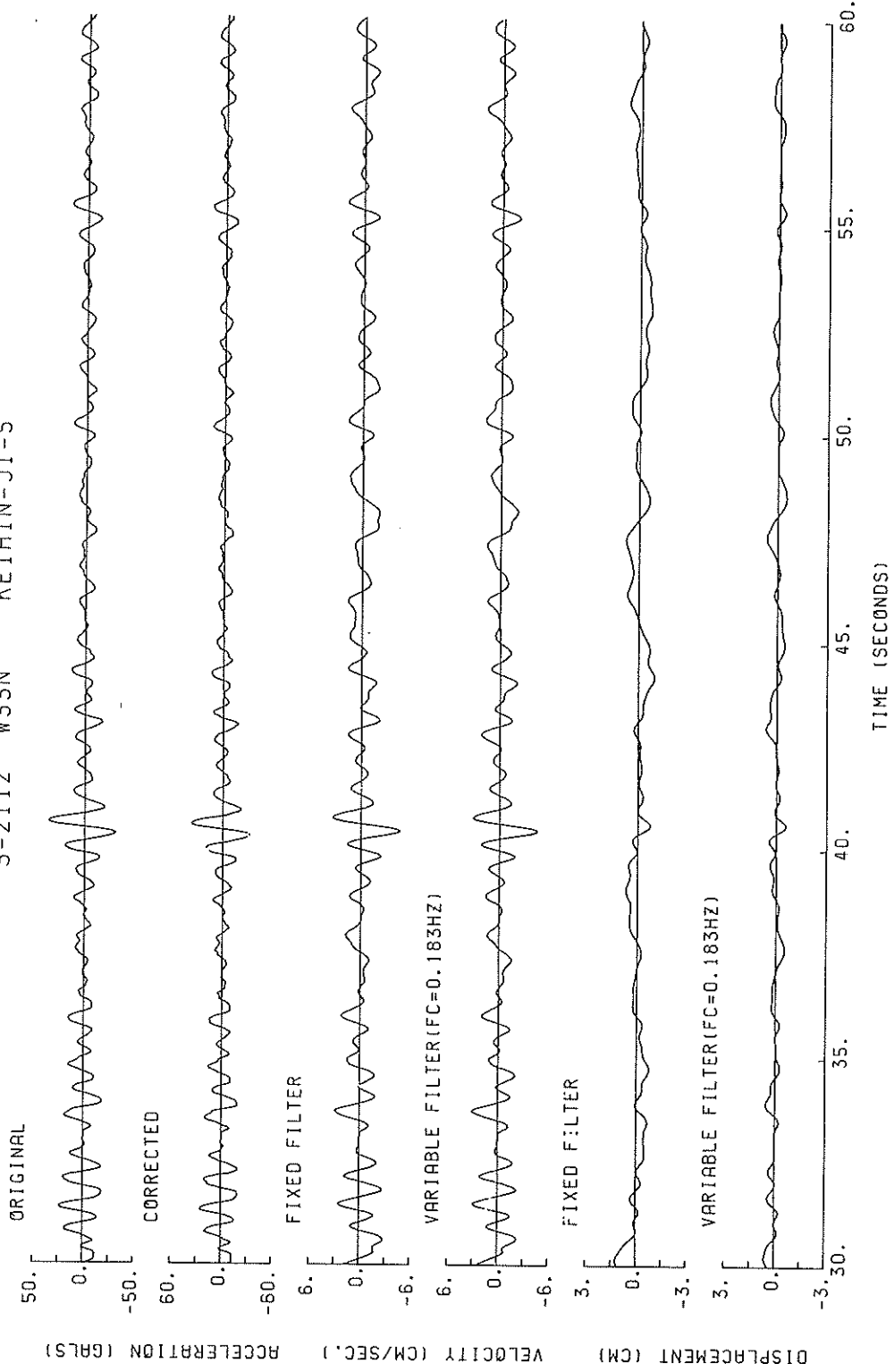

S-2112 DOWN KEIHIN-JI-S

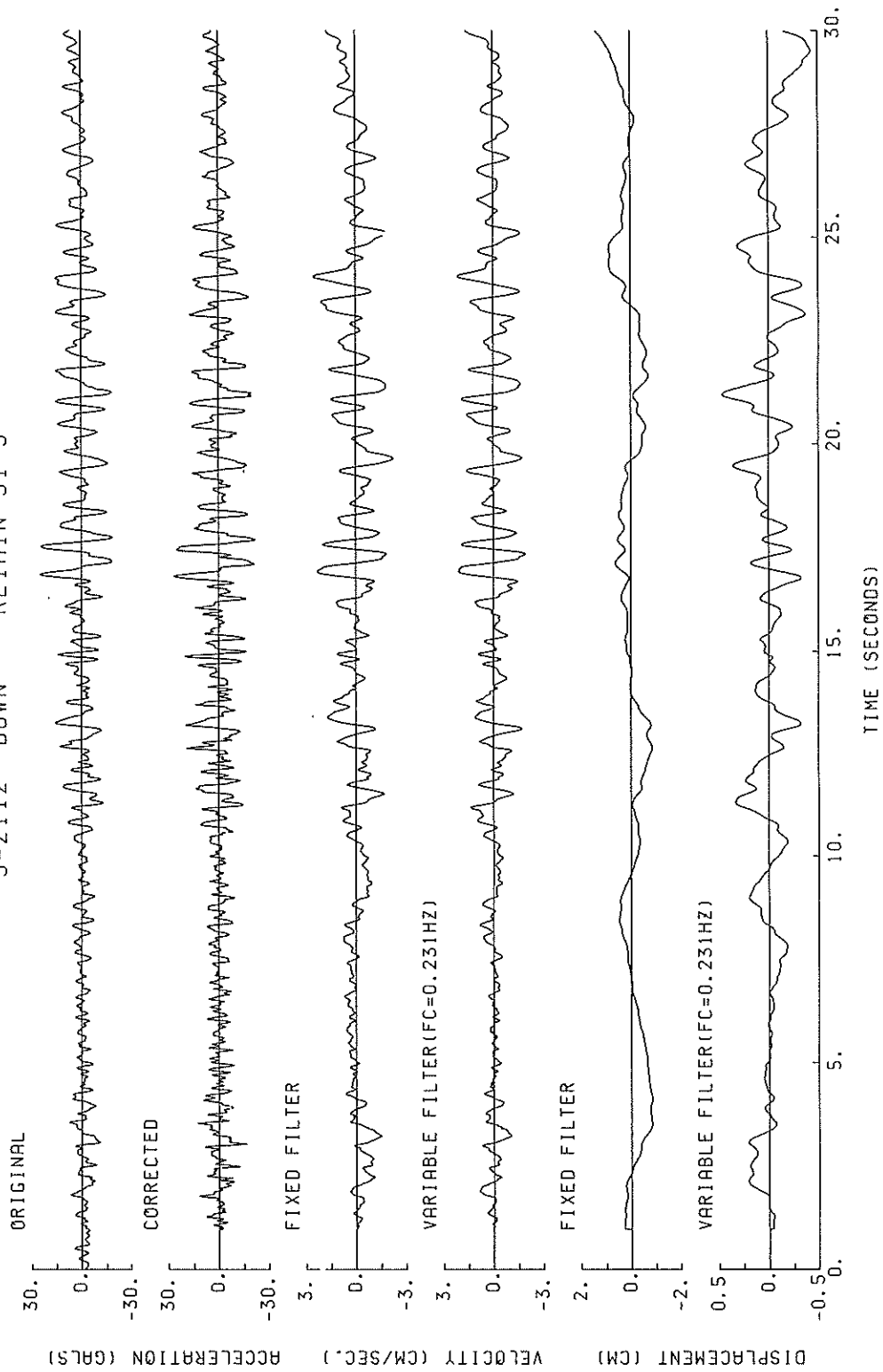

S-2112 DOWN KEIHIN--JI-S

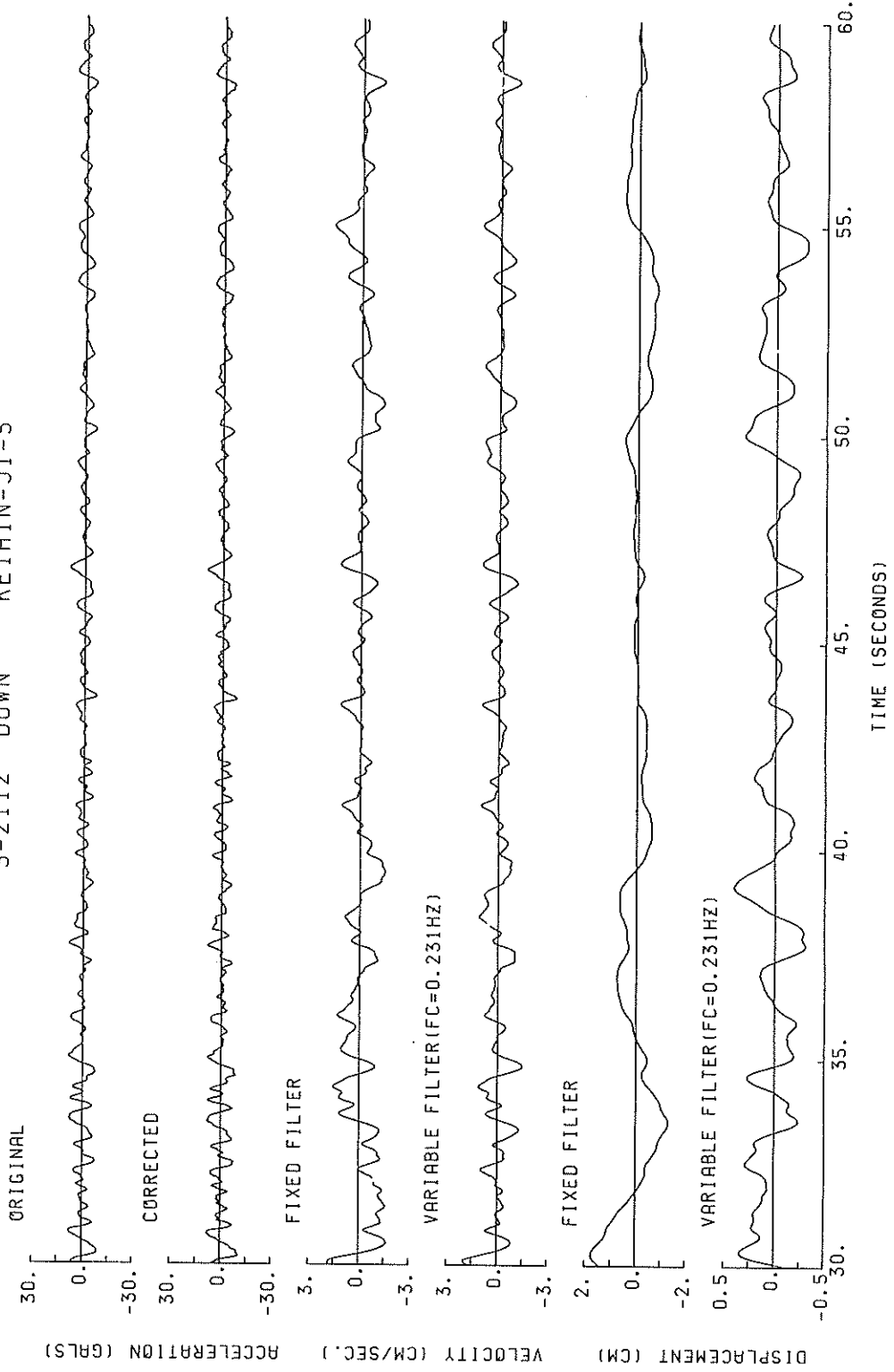

S-2112 N33E KEIHIN-JI-S
(1/FC=6.35 SEC.)

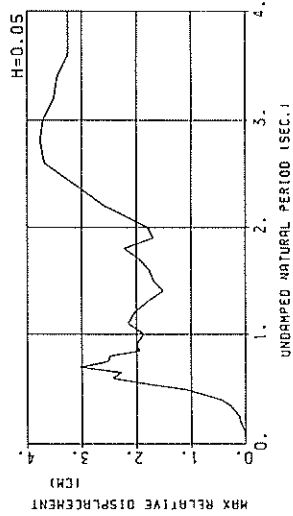
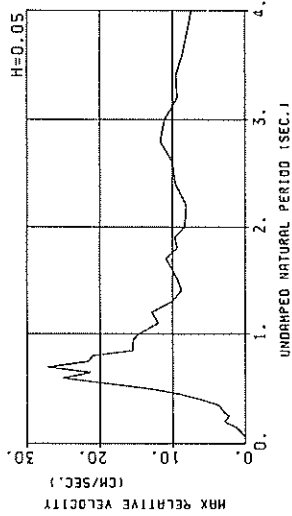
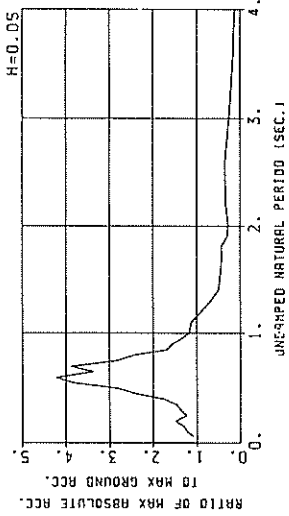

RESPONSE SPECTRA

S-2112 W33N KEIHIN-JI-S
(1/FC=5.47 SEC.)

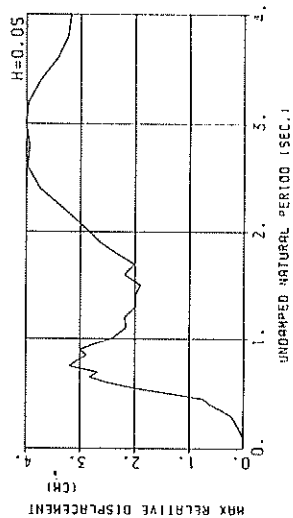
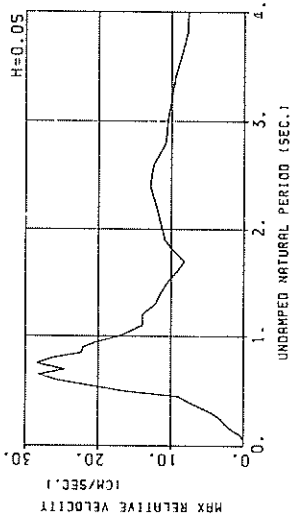
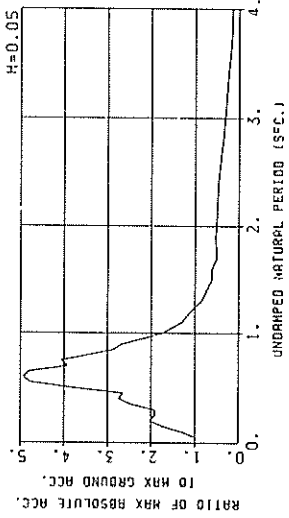

RESPONSE SPECTRA

S-2112 DOWN KEIHIN-JI-S
(1/FC=4.53 SEC.)

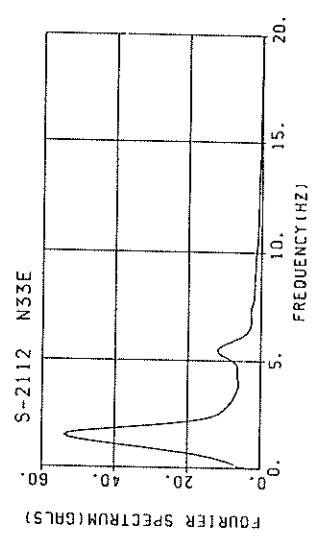
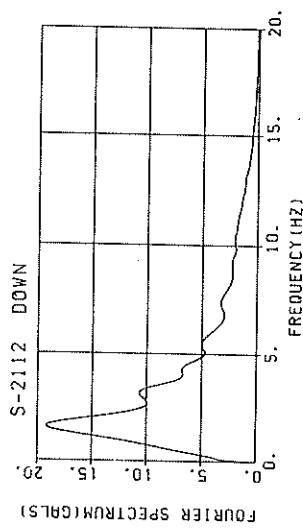
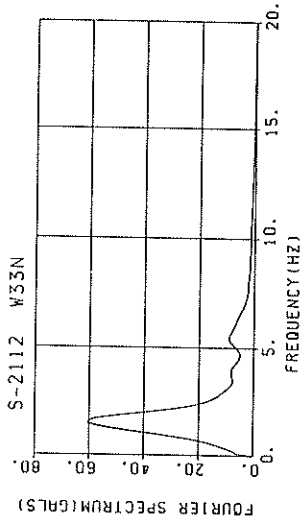
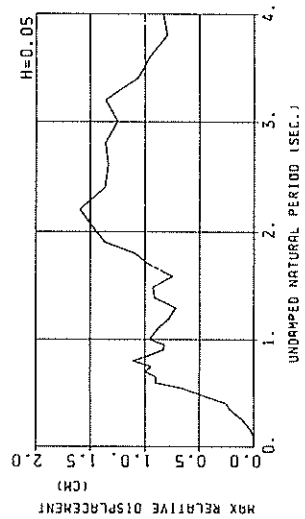
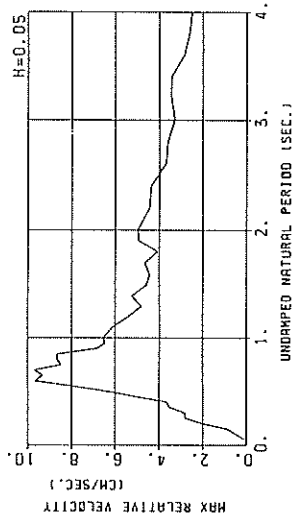
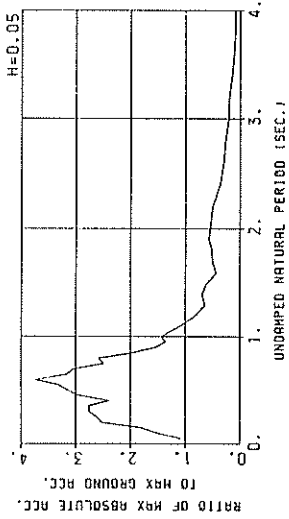

RESPONSE SPECTRA

FOURIER SPECTRA

RESPONSE SPECTRUM

RECORD = S-2112 COMPONENT = N33E SIGNAL = GR. ACC. CORRECTION = STATION = KEIHIN-JI-S
 DATE AND TIME = 1987-12-17-11-08 SAMPRING INTERVAL = 0.0100(SEC) MAX-GROUND ACC. = 63.46 (GAL)
 TIME LENGTH = 89.49 (SEC) SKIPPED LENGTH = 0.00 (SEC)

PER	DAMPING = 0.			DAMPING = 0.025			DAMPING = 0.050			DAMPING = 0.100			DAMPING = 0.250		
	AA	RV	RD	AA	RV	RD	AA	RV	RD	AA	RV	RD	AA	RV	RD
0.05	69.3	0.11	0.004	67.2	0.09	0.004	66.3	0.08	0.004	65.3	0.08	0.004	64.6	0.07	0.004
0.10	131.5	1.19	0.033	82.6	0.61	0.021	76.9	0.48	0.019	72.5	0.36	0.018	68.6	0.28	0.017
0.15	138.9	2.74	0.079	84.8	1.56	0.048	82.0	1.29	0.047	76.7	1.04	0.045	69.5	0.80	0.039
0.20	250.2	6.73	0.254	112.3	3.16	0.114	94.3	2.90	0.095	77.1	2.29	0.078	63.7	1.29	0.063
0.25	125.6	4.02	0.199	81.7	2.59	0.129	78.2	2.29	0.124	69.6	2.08	0.109	64.4	1.58	0.101
0.30	380.7	17.75	0.868	106.3	4.51	0.242	86.6	3.10	0.196	77.4	2.64	0.176	71.9	2.03	0.161
0.35	268.1	14.65	0.832	114.0	4.71	0.253	92.7	3.66	0.288	85.1	3.25	0.263	80.5	3.84	0.243
0.40	268.7	16.65	1.089	139.3	7.82	0.363	109.6	5.89	0.442	99.2	4.55	0.399	91.0	3.99	0.354
0.45	231.4	15.40	1.187	181.6	11.03	0.930	152.8	9.00	0.781	127.8	7.48	0.659	102.3	5.19	0.697
0.50	348.9	25.63	2.209	199.8	14.34	1.263	178.4	12.93	1.125	155.1	10.81	0.968	112.5	6.46	0.859
0.55	849.3	73.91	6.508	298.2	24.49	2.280	244.9	19.23	1.869	193.0	14.24	1.385	114.6	7.55	0.814
0.60	1037.4	98.33	9.660	388.2	36.17	3.539	269.0	25.08	2.441	192.0	16.70	1.720	114.6	8.73	0.937
0.65	433.9	44.69	4.665	229.0	23.39	2.447	214.3	21.29	2.282	176.7	17.36	1.855	107.9	9.61	1.021
0.70	908.3	101.36	11.274	356.2	44.19	246.1	246.1	27.20	3.099	167.3	18.10	2.034	98.9	10.11	1.080
0.75	762.5	91.72	10.865	249.8	30.37	3.557	178.3	21.57	2.527	139.7	17.13	1.946	88.6	10.25	1.098
0.80	359.9	46.64	5.835	205.8	27.31	3.333	153.5	20.99	2.473	115.9	16.12	1.833	78.1	10.28	1.084
0.85	505.4	66.71	9.249	145.9	20.60	2.669	106.6	15.36	1.941	90.0	14.13	1.606	68.1	10.13	1.062
0.90	451.5	65.14	9.265	140.1	21.73	2.870	98.4	15.45	2.009	73.2	12.77	1.462	59.3	9.85	1.030
0.95	284.1	44.14	6.494	117.2	20.41	2.673	85.1	15.34	1.932	64.9	12.54	1.436	51.6	9.52	0.989
1.00	158.2	26.04	4.006	95.6	17.85	2.417	74.0	14.63	1.838	55.6	11.85	1.358	45.4	9.12	0.940
1.10	135.6	24.42	4.157	87.2	16.06	2.668	70.7	11.98	2.133	49.0	10.24	1.462	36.3	8.27	0.910
1.20	147.3	28.68	5.372	73.8	16.40	2.687	56.1	12.89	2.033	36.9	8.90	1.309	29.0	7.69	0.877
1.30	94.1	19.95	4.027	54.8	12.95	2.340	42.3	10.03	1.797	30.8	7.59	1.268	24.5	7.37	0.818
1.40	84.7	19.34	4.208	41.3	10.76	2.047	30.5	8.75	1.507	24.8	7.63	1.200	21.8	7.17	0.823
1.50	53.4	16.80	3.159	38.3	10.70	2.176	29.8	9.28	1.609	20.7	7.64	1.159	19.9	7.03	0.870
1.60	62.3	15.82	4.038	32.7	11.96	2.119	27.4	10.05	1.768	20.1	7.85	1.264	18.6	6.90	0.937
1.70	67.9	19.06	4.974	31.8	13.57	2.323	26.9	10.87	1.944	20.2	8.42	1.410	17.6	6.73	1.012
1.80	64.3	20.68	5.280	37.5	11.32	3.065	27.4	9.36	2.221	19.3	7.98	1.474	16.4	6.46	1.089
1.90	56.3	17.50	5.149	22.9	11.91	2.090	18.7	9.71	1.697	17.0	7.75	1.481	15.8	6.28	1.159
2.00	28.9	11.70	2.932	20.7	9.70	2.091	17.8	8.28	1.793	16.6	7.55	1.611	15.3	6.31	1.222
2.20	59.8	21.47	7.327	24.3	9.35	2.978	16.9	8.06	2.589	16.9	6.89	2.022	14.1	6.18	1.347
2.40	30.2	15.06	4.406	25.3	11.65	3.689	21.7	9.56	3.135	16.8	7.39	2.347	12.7	6.19	1.437
2.60	45.6	21.47	7.804	27.9	12.78	4.759	21.8	9.99	3.691	15.7	7.77	2.594	12.0	6.47	1.568
2.80	50.8	23.03	10.088	23.7	15.12	4.691	19.1	11.68	3.766	14.0	8.63	2.690	11.0	6.69	1.608
3.00	27.4	15.43	6.244	19.7	12.92	4.468	16.5	11.08	3.704	12.1	8.66	2.739	9.7	6.74	1.605
3.20	26.1	14.77	6.772	15.3	10.82	3.964	13.6	9.35	3.509	11.1	7.85	2.800	8.8	6.68	1.786
3.40	15.3	12.30	4.474	13.2	10.73	3.864	11.9	9.49	3.445	9.9	7.93	2.778	8.6	6.62	1.931
3.60	18.0	10.94	5.907	10.6	9.01	3.484	10.0	8.55	3.249	9.1	7.71	2.863	8.3	6.60	2.048
3.80	20.7	13.84	7.578	9.4	8.23	3.435	9.0	7.94	3.249	8.3	7.55	2.917	7.9	6.61	2.133
4.00	9.8	8.93	5.986	8.4	7.56	3.412	8.2	7.36	3.253	7.7	6.92	2.943	7.5	6.64	2.189

PER = PERIOD (SEC) AA = ABSOLUTE ACC. (GAL) RV = RELATIVE VELOCITY (CM/SEC) RD = RELATIVE DISPLACEMENT (CM)

RESPONSE SPECTRUM

RECORD = S-2112 COMPONENT = W33N SIGNAL = GR. ACC. CORRECTION = STATION = KEIHN-JI-S
 DATE AND TIME = 1987-12-17-11-08 SAMPRING INTERVAL = 0.0100(SEC) MAX. GROUND ACC. = 55.57 (GAL)
 TIME LENGTH = 89.49 (SEC) SKIPPED LENGTH = 0.00 (SEC)

PER	DAMPING = 0.			DAMPING = 0.025			DAMPING = 0.050			DAMPING = 0.100			DAMPING = 0.250		
	AA	RV	RD	AA	RV	RD	AA	RV	RD	AA	RV	RD	AA	RV	RD
0.05	56.5	0.15	0.004	55.6	0.08	0.004	55.5	0.07	0.004	55.5	0.07	0.004	55.6	0.07	0.004
0.10	165.2	2.12	0.042	77.7	0.55	0.020	71.5	0.42	0.018	68.7	0.36	0.017	65.2	0.32	0.016
0.15	364.7	8.41	0.208	108.3	2.38	0.052	97.1	1.76	0.035	88.6	1.15	0.050	75.7	0.75	0.041
0.20	242.2	7.26	0.245	137.3	3.19	0.159	112.8	2.59	0.115	90.6	2.08	0.090	76.9	1.30	0.074
0.25	351.4	12.56	0.356	129.8	4.52	0.206	106.4	3.26	0.167	92.5	2.63	0.137	75.3	1.87	0.113
0.30	148.2	5.85	0.338	130.9	5.25	0.298	106.9	4.30	0.242	92.5	3.50	0.209	78.7	2.39	0.169
0.35	368.3	18.47	1.143	179.0	8.20	0.556	137.2	6.03	0.423	102.6	4.27	0.315	80.7	2.96	0.236
0.40	308.5	18.49	1.250	169.1	8.54	0.686	152.4	7.60	0.616	123.5	6.00	0.493	87.7	4.12	0.331
0.45	308.6	21.32	1.583	191.5	12.06	0.982	147.5	9.09	0.733	126.3	7.73	0.640	91.7	5.19	0.437
0.50	582.9	45.62	3.691	271.8	20.90	1.716	212.5	16.57	1.339	157.8	11.76	0.982	96.0	6.34	0.553
0.55	825.4	71.53	6.324	380.0	31.53	2.910	266.0	21.37	2.031	171.6	13.34	1.293	96.1	7.45	0.668
0.60	648.8	61.31	5.916	388.4	36.18	3.537	273.8	25.66	2.484	189.4	17.22	1.692	98.7	8.37	0.814
0.65	1230.8	126.83	13.172	396.1	41.37	4.232	266.5	28.21	2.836	169.9	17.95	1.777	95.4	9.12	0.922
0.70	591.8	66.13	7.345	246.9	27.90	3.060	217.6	24.66	2.466	153.8	18.21	1.871	91.6	9.53	1.003
0.75	532.0	63.68	7.580	291.3	34.92	4.145	226.4	28.47	3.204	156.7	19.27	2.181	86.9	9.59	1.070
0.80	688.1	87.92	11.155	249.2	32.77	4.032	190.1	26.21	3.063	133.4	18.52	2.106	79.9	9.92	1.070
0.85	441.4	60.74	8.078	210.4	28.65	3.844	158.5	22.28	2.884	113.7	16.50	2.026	74.8	9.98	1.169
0.90	573.2	82.29	11.761	213.2	30.76	4.369	147.4	22.04	3.004	96.1	15.80	1.915	68.2	9.79	1.171
0.95	329.4	51.58	7.531	168.0	27.54	3.836	122.4	20.19	2.781	83.6	14.56	1.867	61.3	9.46	1.147
1.00	245.7	39.86	6.224	110.7	19.86	2.798	96.4	17.06	2.428	74.2	13.44	1.831	54.5	9.21	1.106
1.10	119.2	22.59	3.652	81.3	15.76	2.487	71.2	13.89	2.168	60.5	11.95	1.800	43.0	8.87	1.116
1.20	248.5	47.51	9.100	76.3	16.48	2.778	60.4	13.87	2.185	48.0	11.65	1.695	35.8	8.49	1.067
1.30	109.7	23.24	4.698	56.1	13.17	2.396	46.5	12.11	1.975	40.2	10.57	1.668	31.3	8.19	1.103
1.40	80.8	20.82	4.012	50.3	13.84	2.492	40.4	11.43	1.986	32.8	9.57	1.566	27.5	7.99	1.095
1.50	72.1	17.21	4.107	45.1	12.23	2.569	33.5	10.55	1.896	24.7	9.21	1.321	23.8	7.73	1.062
1.60	119.3	30.56	7.739	48.4	12.86	3.131	33.9	9.23	2.185	23.6	8.20	1.478	20.7	7.44	1.068
1.70	53.5	14.84	3.915	30.9	8.89	2.262	27.5	8.13	2.004	23.5	7.67	1.676	18.7	7.12	1.181
1.80	53.4	15.59	4.384	33.0	10.65	2.707	28.9	9.78	2.357	23.1	8.66	1.676	18.6	6.80	1.322
1.90	92.2	27.43	8.429	35.1	11.99	3.206	29.1	10.91	2.546	22.4	9.41	2.024	18.3	6.92	1.457
2.00	46.1	18.12	4.671	33.8	13.65	3.414	28.4	11.24	2.848	22.0	9.77	2.185	17.9	7.10	1.584
2.20	44.5	5.458	3.458	33.3	14.15	4.078	27.1	11.95	3.282	21.2	9.73	2.561	16.9	7.16	1.836
2.40	54.9	21.51	8.012	32.0	15.25	4.652	25.9	12.87	3.743	21.0	9.76	3.143	15.6	6.88	2.065
2.60	46.2	19.28	7.905	27.5	15.17	4.699	23.4	12.36	3.977	19.3	9.11	3.198	14.8	6.94	2.264
2.80	47.6	21.94	9.648	23.4	12.20	4.638	20.1	10.75	3.947	17.7	8.52	3.401	13.8	7.10	2.419
3.00	23.4	14.00	5.328	19.0	11.89	4.509	17.8	10.55	4.007	16.1	8.52	3.509	12.8	7.16	2.513
3.20	28.5	15.41	7.398	16.5	11.09	4.261	15.5	9.97	3.964	14.3	8.41	3.487	11.8	7.14	2.545
3.40	16.1	11.62	4.704	13.9	10.17	4.067	12.9	9.46	3.728	12.3	8.22	3.346	10.8	7.06	2.526
3.60	20.7	12.41	6.782	11.5	8.99	3.765	10.6	8.59	3.420	10.4	7.79	3.146	9.9	6.93	2.467
3.80	12.0	10.20	4.394	9.4	8.78	3.449	8.9	7.77	3.254	8.8	7.43	2.937	8.9	6.78	2.381
4.00	17.5	12.58	7.111	8.4	8.45	3.377	7.9	7.67	3.180	7.5	7.12	2.799	8.1	6.62	2.278

PER = PERIOD (SEC) AA = ABSOLUTE ACC. (GAL) RV = RELATIVE VELOCITY (CM/SEC) RD = RELATIVE DISPLACEMENT (CM)

RESPONSE SPECTRUM

RECORD = S-2112 COMPONENT = DOWN SIGNAL = GR. ACC. CORRECTION = STATION = KEIHN-JI-S
 DATE AND TIME = 1987-12-17-11-08 SAMPRING INTERVAL = 0.0100(SEC) MAX.GROUND ACC. = 26.63 (GAL)
 TIME LENGTH = 89.49 (SEC) SKIPPED LENGTH = 0.00 (SEC)

PER	DAMPING = 0.				DAMPING = 0.025				DAMPING = 0.050				DAMPING = 0.100				DAMPING = 0.250			
	AA	RV	RD	AA	RV	RD	AA	RV	RD	AA	RV	RD	AA	RV	RD	AA	RV	RD		
0.05	28.0	0.13	0.082	28.5	0.05	0.002	28.2	0.05	0.002	27.7	0.05	0.002	27.1	0.05	0.002	27.1	0.05	0.002		
0.10	167.4	2.59	0.042	51.6	0.64	0.013	39.7	0.44	0.010	32.0	0.32	0.008	29.6	0.21	0.007	29.6	0.21	0.007		
0.15	117.4	2.75	0.067	56.0	1.06	0.032	48.4	0.88	0.028	43.0	0.64	0.024	36.4	0.43	0.020	36.4	0.43	0.020		
0.20	95.9	2.76	0.097	73.0	2.23	0.074	67.1	1.98	0.068	56.8	1.52	0.057	41.4	0.92	0.040	41.4	0.92	0.040		
0.25	158.4	5.89	0.251	94.3	3.52	0.150	69.4	2.78	0.110	53.1	2.13	0.083	41.0	1.24	0.061	41.0	1.24	0.061		
0.30	260.7	12.23	0.594	100.1	4.52	0.228	73.3	2.81	0.167	56.6	2.08	0.127	39.1	1.24	0.083	39.1	1.24	0.083		
0.35	385.5	21.23	1.196	103.9	5.31	0.322	75.5	3.54	0.228	56.0	2.40	0.171	40.8	1.64	0.118	40.8	1.64	0.118		
0.40	248.6	15.61	1.007	92.2	5.42	0.373	63.5	3.65	0.256	53.2	2.63	0.212	41.5	1.97	0.154	41.5	1.97	0.154		
0.45	144.3	9.92	0.740	104.4	7.05	0.535	78.8	5.07	0.403	59.7	3.67	0.301	42.9	2.44	0.199	42.9	2.44	0.199		
0.50	121.4	9.49	0.769	93.5	7.33	0.592	83.9	6.28	0.529	65.9	4.91	0.410	43.6	3.05	0.247	43.6	3.05	0.247		
0.55	170.2	15.00	1.304	93.6	8.65	0.715	88.6	7.99	0.675	67.8	5.81	0.510	42.8	3.56	0.287	42.8	3.56	0.287		
0.60	540.6	51.32	4.929	164.6	15.61	1.498	99.4	9.66	0.903	68.8	6.57	0.615	43.4	3.93	0.351	43.4	3.93	0.351		
0.65	278.3	28.76	2.978	100.5	11.32	1.073	84.2	9.32	0.896	64.2	7.11	0.672	42.3	4.11	0.394	42.3	4.11	0.394		
0.70	338.4	37.39	4.200	102.3	11.95	1.268	80.7	9.71	0.995	61.9	7.21	0.750	39.4	4.06	0.420	39.4	4.06	0.420		
0.75	146.0	17.44	2.081	72.2	9.53	1.026	66.4	8.48	0.940	54.9	7.00	0.761	35.4	4.35	0.427	35.4	4.35	0.427		
0.80	262.6	33.53	4.258	99.8	12.79	1.616	68.9	8.66	1.111	46.9	7.10	0.738	30.8	4.49	0.438	30.8	4.49	0.438		
0.85	78.6	10.96	1.438	62.7	10.06	1.146	52.8	8.67	0.860	41.7	6.94	0.745	28.1	4.49	0.438	28.1	4.49	0.438		
0.90	158.6	22.63	3.253	41.7	6.55	0.853	40.8	6.83	0.831	36.8	6.28	0.732	26.2	4.36	0.459	26.2	4.36	0.459		
0.95	74.8	11.63	1.710	37.0	6.97	0.843	36.1	6.47	0.819	33.0	5.72	0.729	24.1	4.13	0.478	24.1	4.13	0.478		
1.00	108.3	17.04	2.743	46.6	7.79	1.179	38.0	6.54	0.956	30.2	5.45	0.737	21.9	3.86	0.460	21.9	3.86	0.460		
1.10	61.6	11.00	1.888	33.3	6.97	1.018	29.1	6.12	0.885	23.8	4.92	0.703	17.3	3.57	0.446	17.3	3.57	0.446		
1.20	89.2	16.88	3.254	29.9	6.26	1.088	21.6	5.44	0.780	17.8	4.56	0.619	14.4	3.29	0.427	14.4	3.29	0.427		
1.30	35.9	7.65	1.537	22.4	5.10	0.937	16.9	4.81	0.716	13.6	4.19	0.561	11.8	3.20	0.411	11.8	3.20	0.411		
1.40	38.2	8.55	1.898	24.4	6.21	1.209	18.5	5.25	0.910	13.4	4.42	0.641	10.4	3.30	0.452	10.4	3.30	0.452		
1.50	32.8	8.40	1.868	20.8	4.75	1.185	16.4	4.59	0.926	12.7	4.30	0.705	10.2	3.32	0.500	10.2	3.32	0.500		
1.60	38.5	9.83	2.494	13.7	4.45	0.889	11.6	4.42	0.744	11.5	4.15	0.721	9.8	3.27	0.540	9.8	3.27	0.540		
1.70	28.4	8.26	2.080	17.7	5.33	1.295	13.3	4.64	0.964	11.5	4.02	0.815	9.4	3.15	0.572	9.4	3.15	0.572		
1.80	36.9	10.76	3.025	18.3	4.83	1.466	13.5	4.05	1.096	11.1	3.65	0.878	8.8	2.99	0.593	8.8	2.99	0.593		
1.90	41.9	12.65	3.836	21.1	6.66	1.922	15.0	4.93	1.366	10.6	3.63	0.936	8.2	2.79	0.601	8.2	2.79	0.601		
2.00	35.8	11.49	3.632	19.1	6.40	1.933	14.4	4.96	1.446	10.1	3.57	0.990	7.6	2.70	0.597	7.6	2.70	0.597		
2.20	4.301	12.21	4.301	19.1	6.59	2.337	13.1	4.43	1.598	9.1	3.54	1.092	6.3	2.76	0.664	6.3	2.76	0.664		
2.40	16.8	7.63	2.455	12.2	5.36	1.779	9.4	4.38	1.367	7.2	3.51	1.019	5.1	2.72	0.588	5.1	2.72	0.588		
2.60	35.5	11.01	4.373	10.8	4.65	1.848	7.9	3.70	1.339	5.8	3.10	0.945	4.5	2.61	0.582	4.5	2.61	0.582		
2.80	33.8	15.46	6.711	11.4	5.34	2.270	6.9	3.60	1.368	4.8	2.89	0.932	4.2	2.68	0.572	4.2	2.68	0.572		
3.00	14.5	7.50	3.301	7.2	4.15	1.645	5.5	3.50	1.254	4.1	2.76	0.907	3.6	2.37	0.584	3.6	2.37	0.584		
3.20	12.6	7.38	3.273	7.4	4.16	1.930	3.9	3.44	1.366	3.9	2.78	0.933	3.5	2.33	0.626	3.5	2.33	0.626		
3.40	8.9	5.29	2.612	4.5	3.88	1.310	3.8	3.44	1.068	3.2	2.86	0.852	3.2	2.39	0.646	3.2	2.39	0.646		
3.60	6.2	4.21	2.047	4.0	3.05	1.299	2.9	2.85	0.953	2.6	2.86	0.852	3.0	2.41	0.657	3.0	2.41	0.657		
3.80	5.0	3.38	1.829	2.8	2.67	1.005	2.2	2.62	0.796	2.2	2.55	0.704	2.40	2.40	0.661	2.40	2.40	0.661		
4.00	3.4	2.93	1.396	2.4	2.55	0.988	2.1	2.49	0.830	2.0	2.47	0.703	2.6	2.38	0.667	2.6	2.38	0.667		

PER = PERIOD (SEC) AA = ABSOLUTE ACC. (GAL) RV = RELATIVE VELOCITY (CM/SEC) RD = RELATIVE DISPLACEMENT (CM)

S-2112 KEIHIN-JI-S

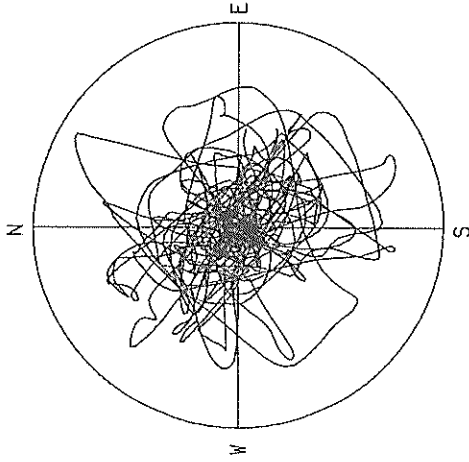

ACCELERATION
R=70.0 GAL
MAX=63.6 GAL

S-2112 KEIHIN-JI-S

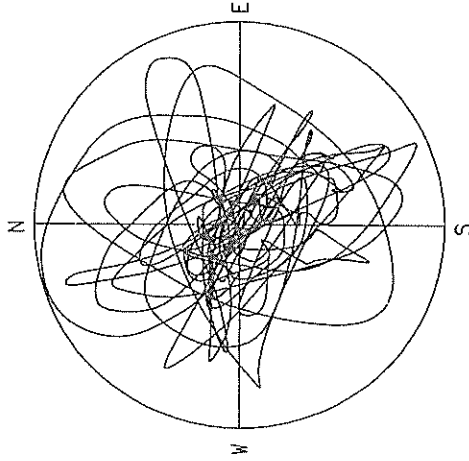

VELOCITY
R=7.0 CM/SEC.
MAX=6.9 CM/SEC.

S-2112 KEIHIN-JI-S

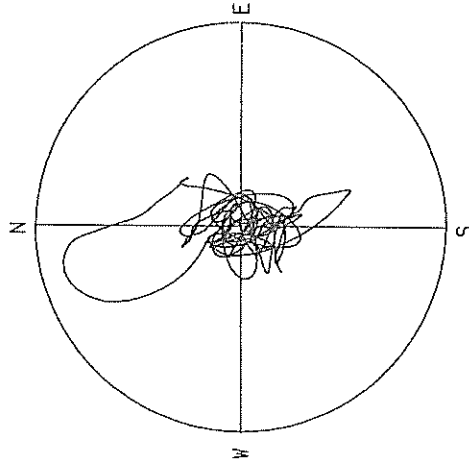

DISPLACEMENT
R=3.00 CM
MAX=2.66 CM

RECORD NUMBER
STATION

S-2113
YAMASHITA-HEN-S

EARTHQUAKE DATA

DATA AND TIME
LOCATION OF HYPOCENTER
EPICENTRAL REGION
LATITUDE
LONGITUDE
DEPTH
MAGNITUDE

11: 8 DEC.17,1987

CHIBA-KEN-TOHO-OKI
35°22' N
140°30' E
58KM
6.7

PEAK VALUES OF COMPONENTS

N S E W U D HORIZONTAL*

PARAMETER OF THE VARIABLE FILTER

FC (HZ) 0.219 0.232 0.378

MAXIMUM ACCELERATION (GAL)

ORIGINAL 88.5 65.5 16.7 95.9
CORRECTED 115.1 74.9 20.8 117.2

MAXIMUM VELOCITY (CM/SEC)

FIXED FILTER 8.00 8.70 1.71 9.03
VARIABLE FILTER 6.17 8.36 1.61 8.38

MAXIMUM DISPLACEMENT (CM)

FIXED FILTER 2.116 2.444 1.056 2.532
VARIABLE FILTER 1.222 1.704 0.183 1.922

* RESULTANT OF HORIZONTAL COMPONENTS

S-2113 YAMASHITA-HEN-S

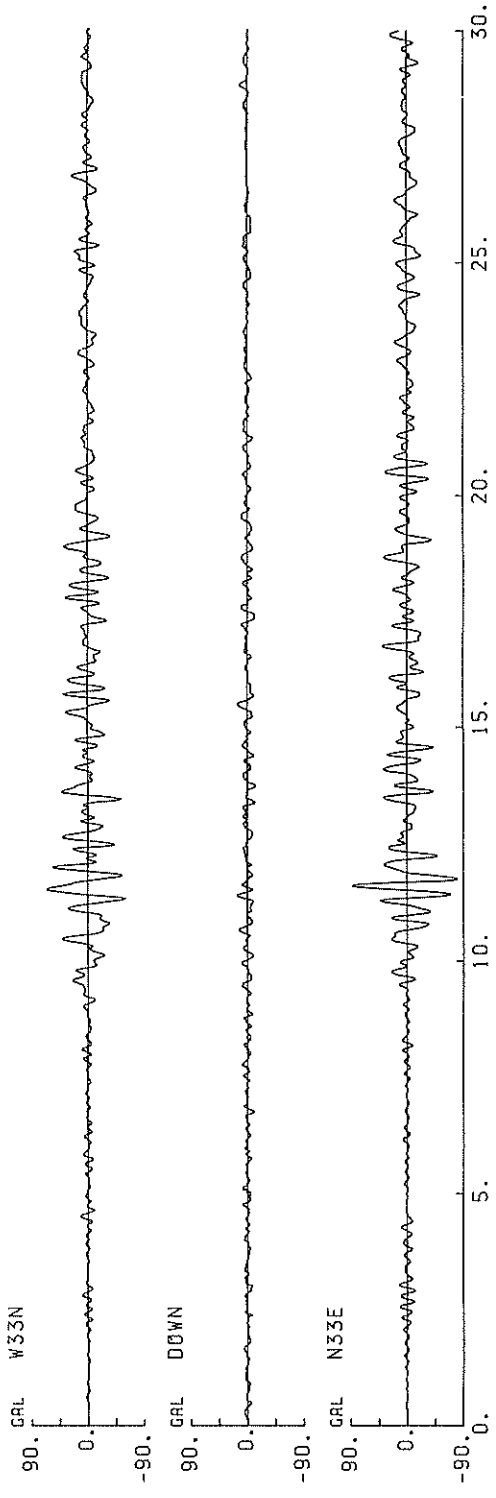

TIME (SECONDS)

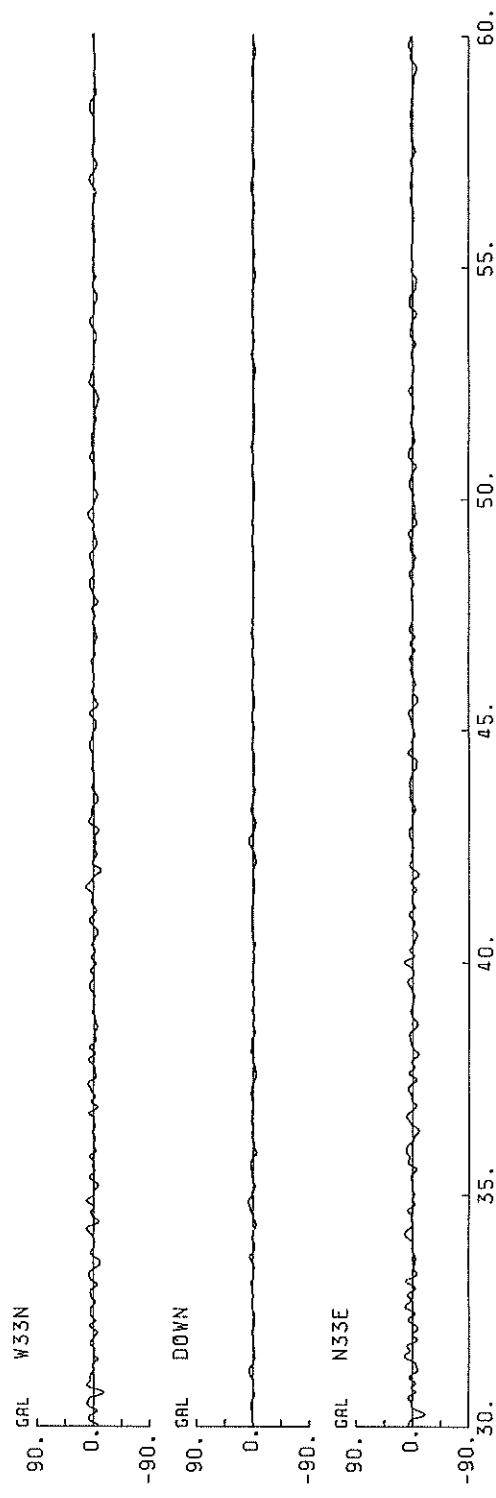

TIME (SECONDS)

S-2113 N33E YAMASHITA-HEN-S

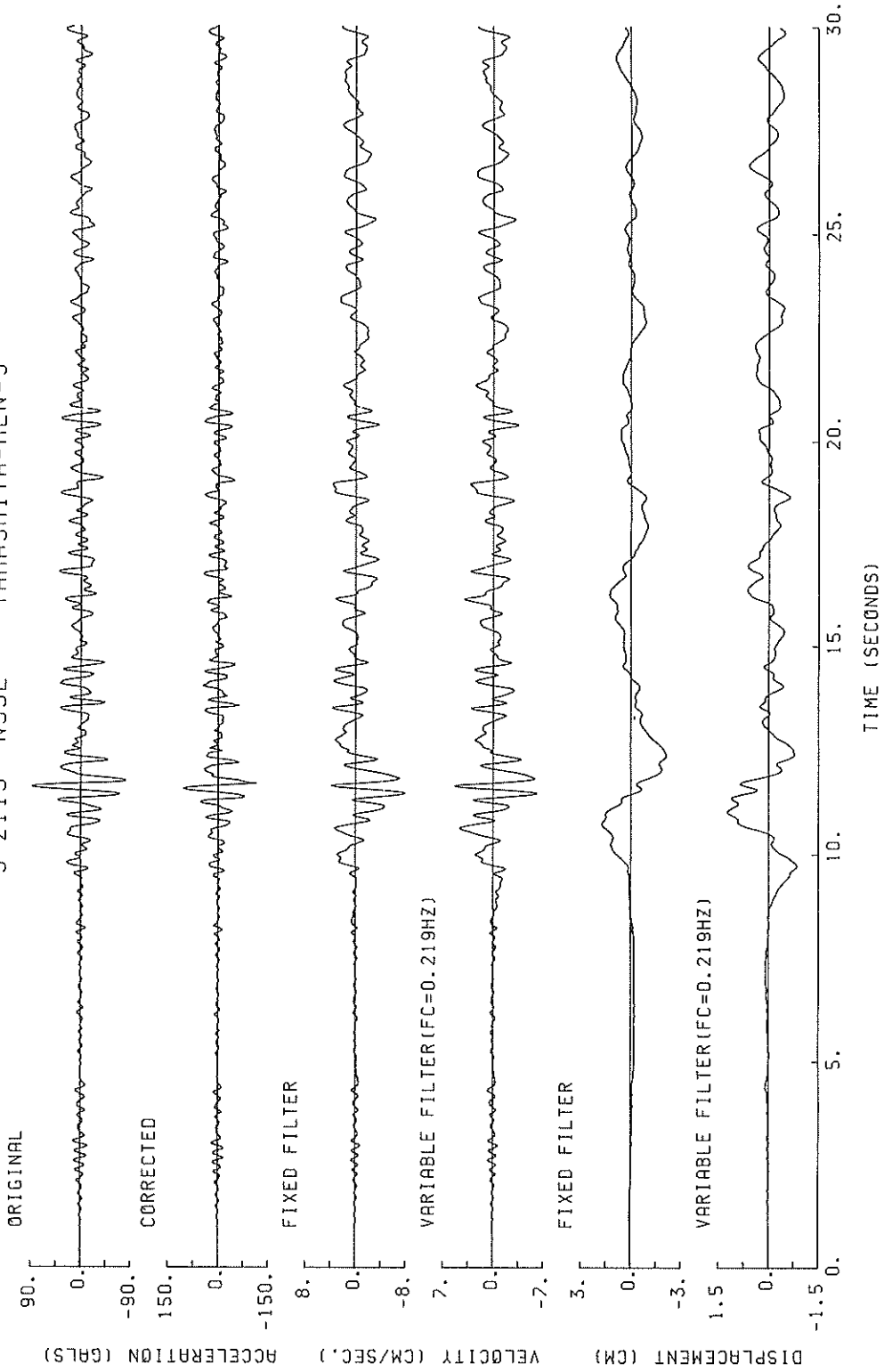

S-2113 N33E YAMASHITA-HEN-S

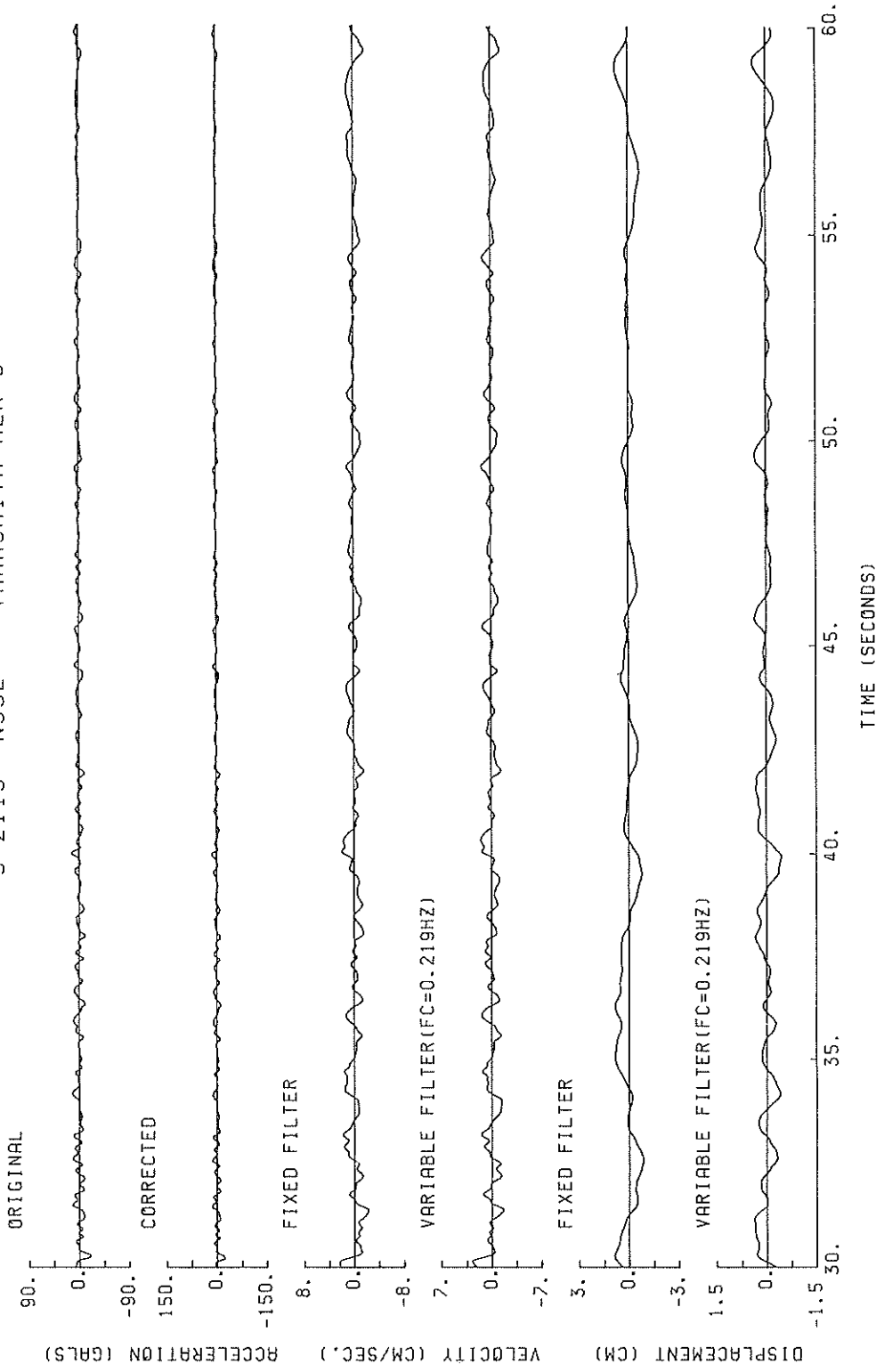

S-2113 W33N YAMASHITA-HEN-S

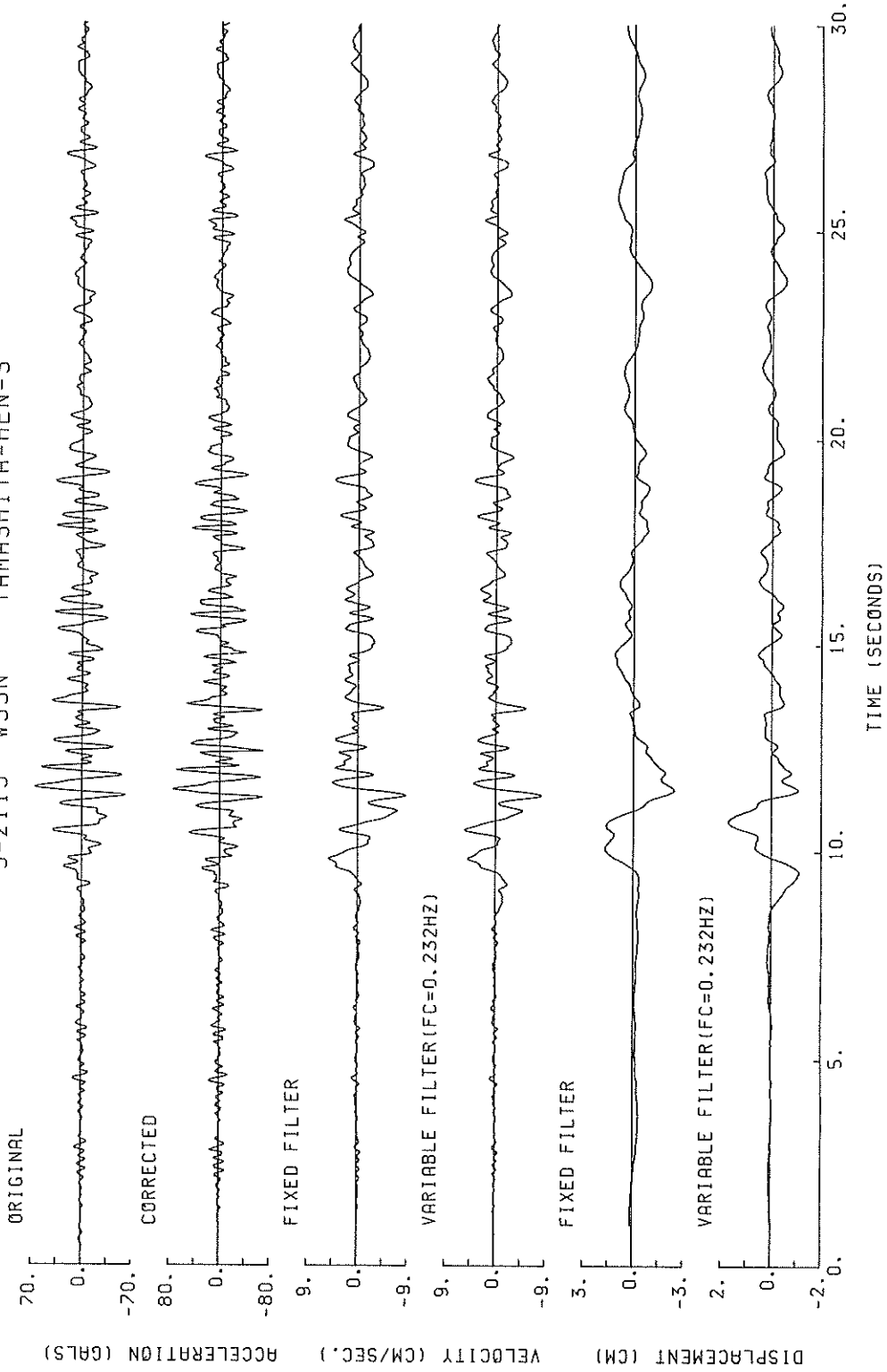

S-2113 W33N YAMASHITA-HEN-S

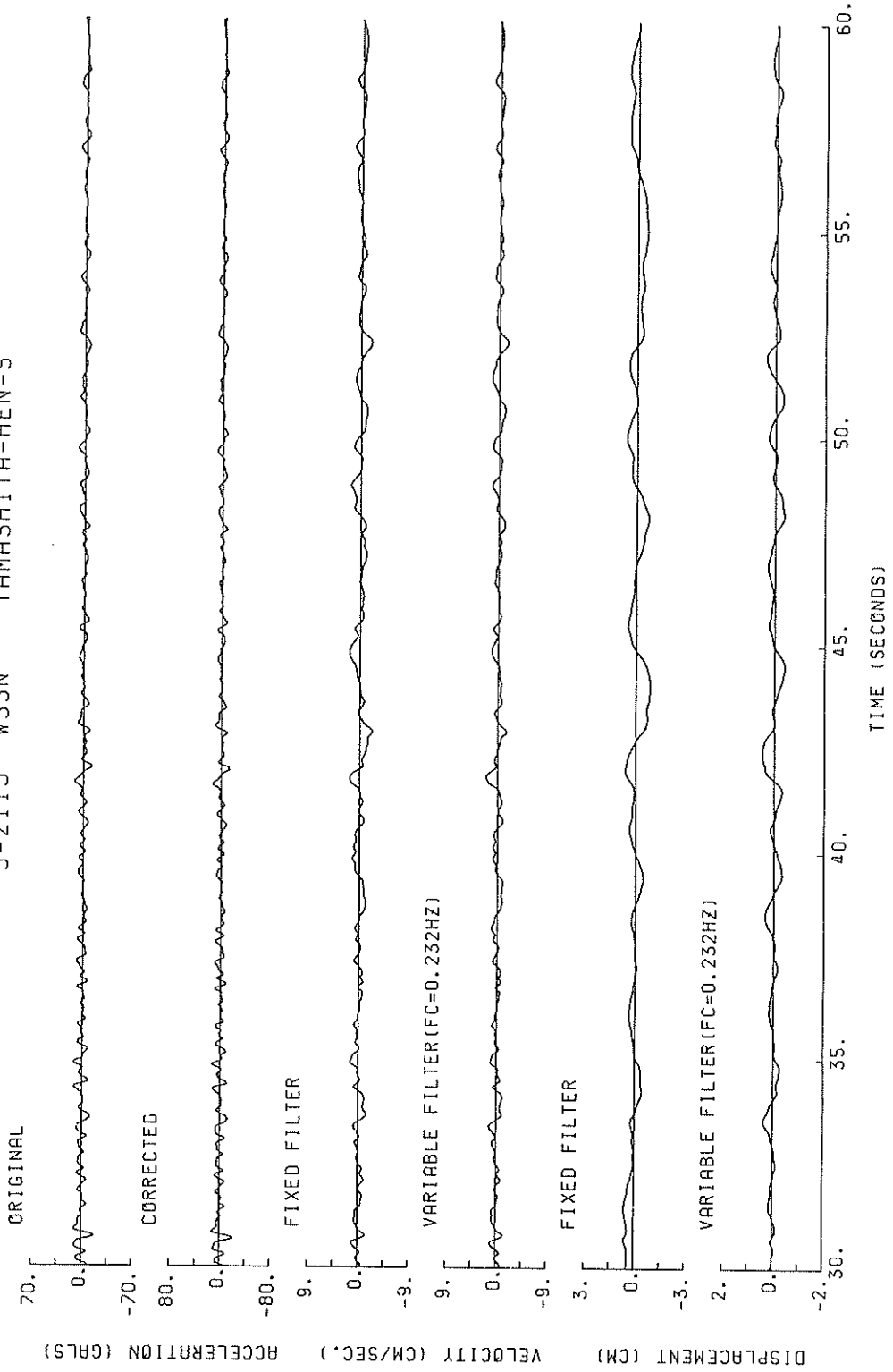

S-2113 DOWN YAMASHITA-HEN-S

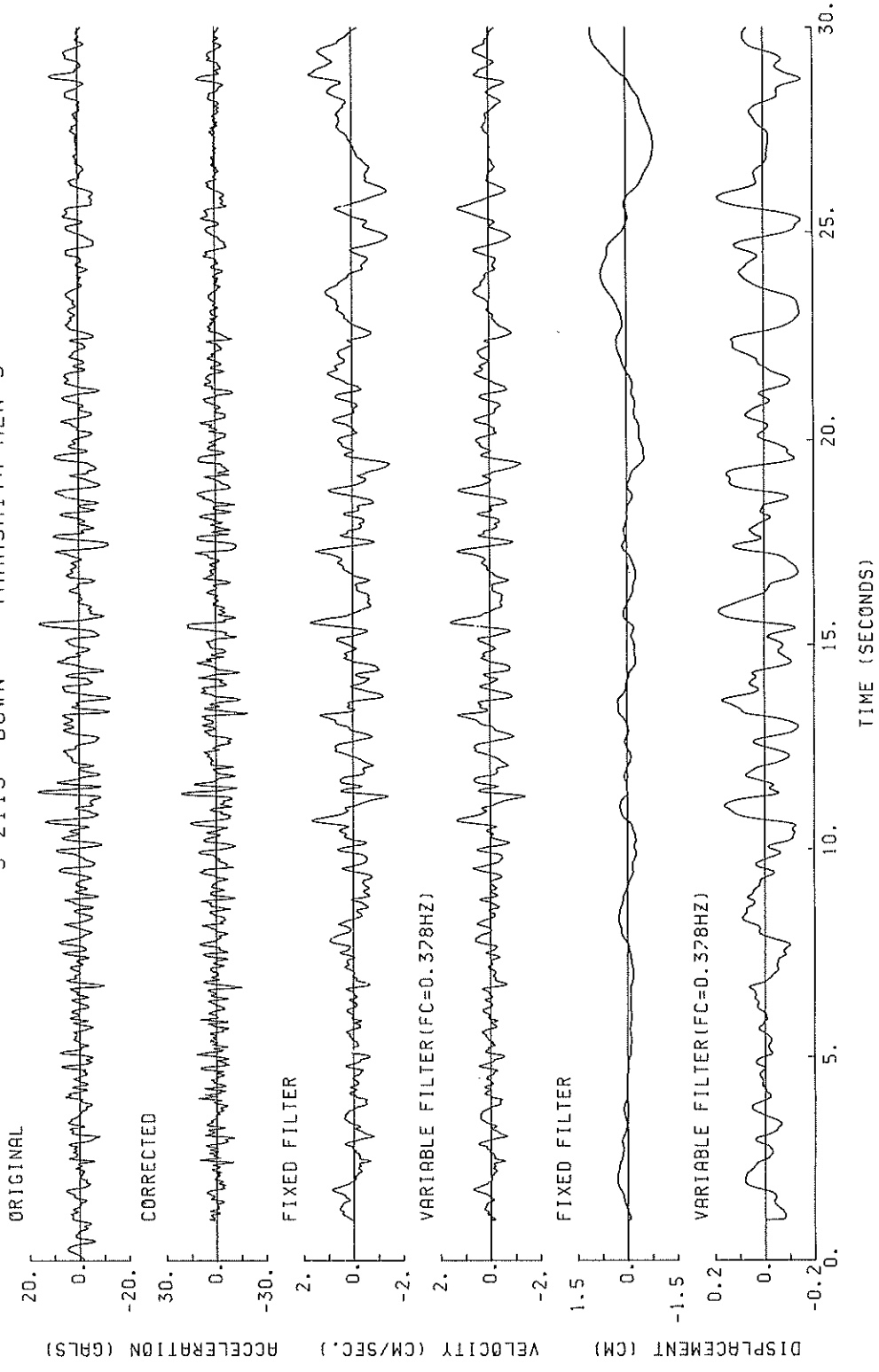

S-2113 DOWN YAMASHITA-HEN-S

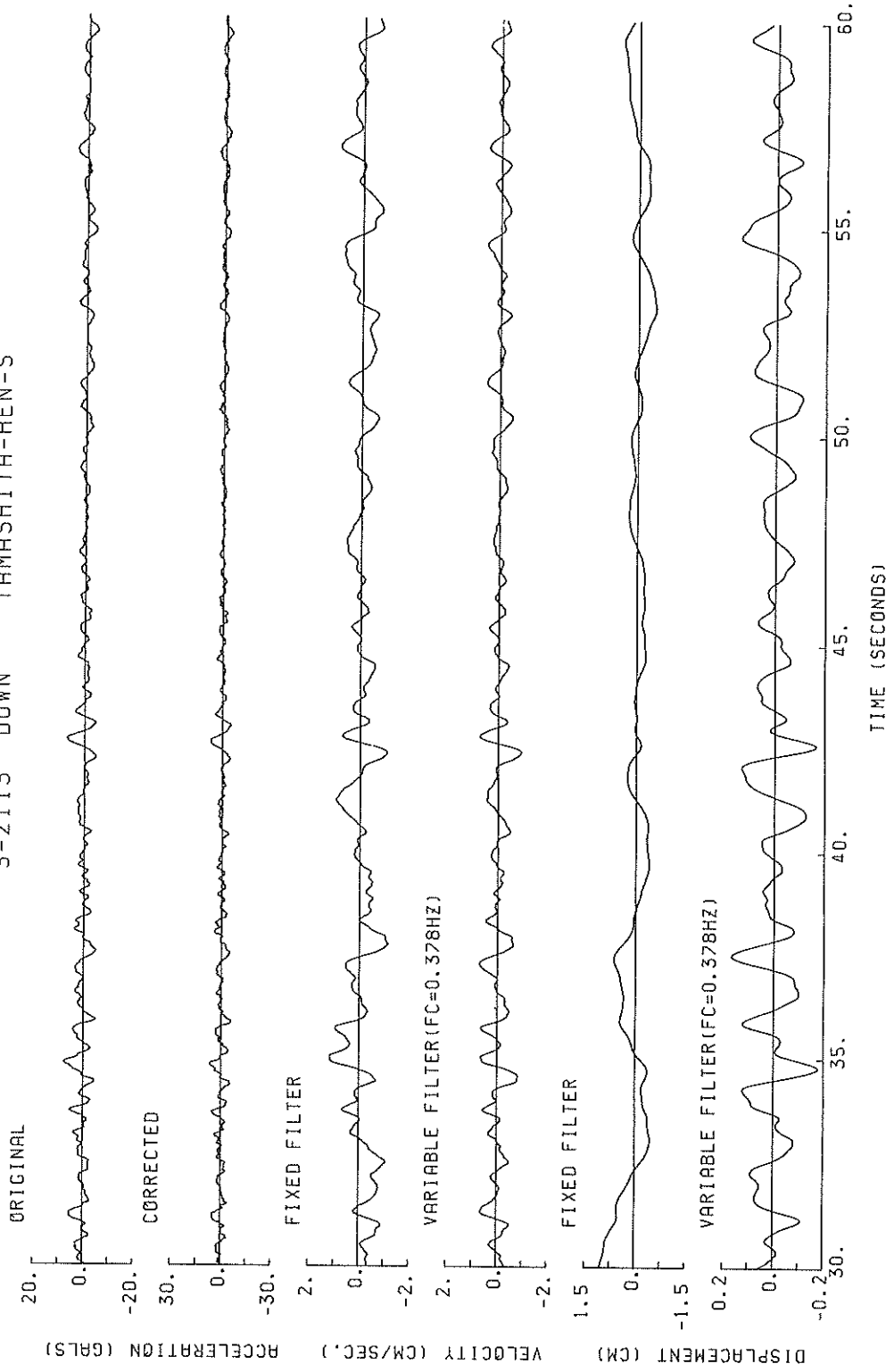

S-2113 N33E YAMASHITA-HEN-S
(1/FC=4.56 SEC.)

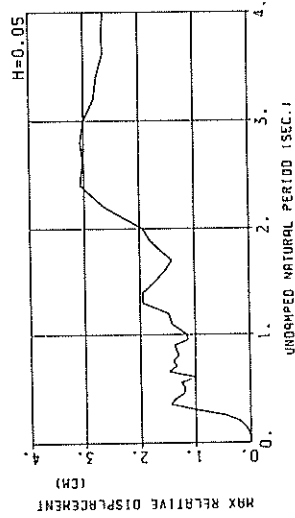
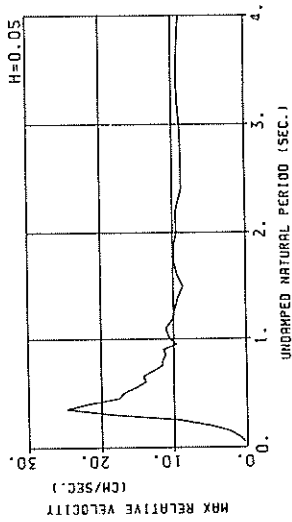
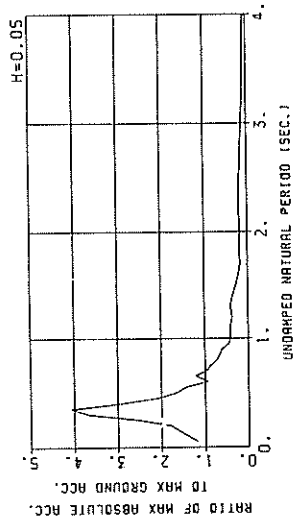

RESPONSE SPECTRA

S-2113 W33N YAMASHITA-HEN-S
(1/FC=4.32 SEC.)

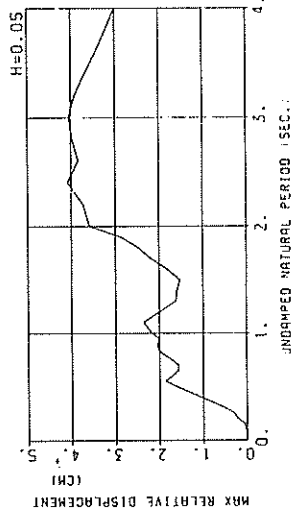
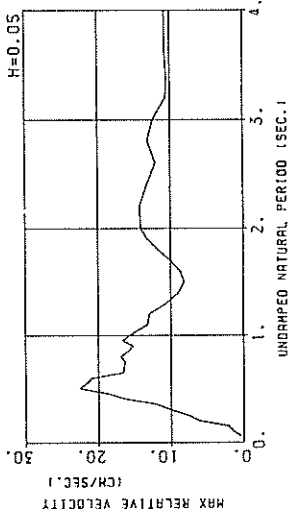
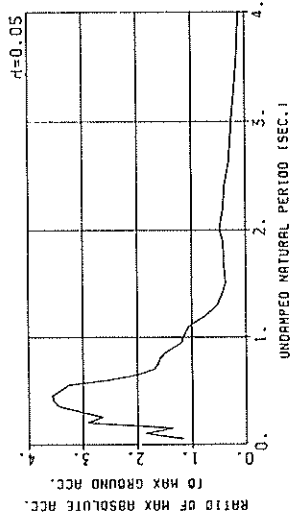

RESPONSE SPECTRA

S-2113 DOWN YAMASHITA-HEN-S
(1/FC=2.64 SEC.)

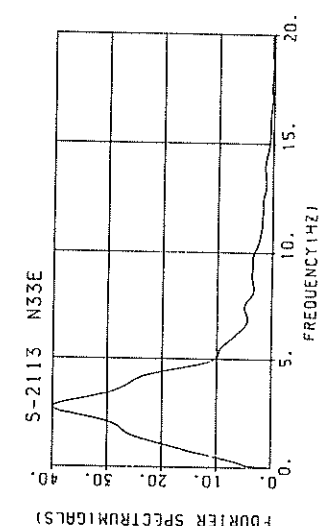
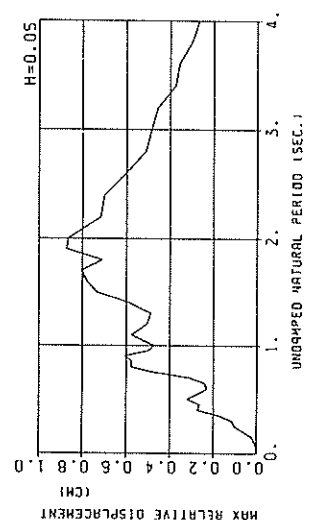
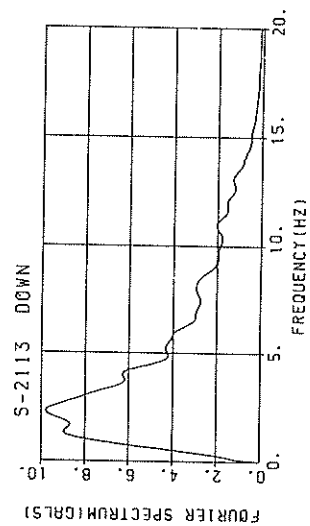
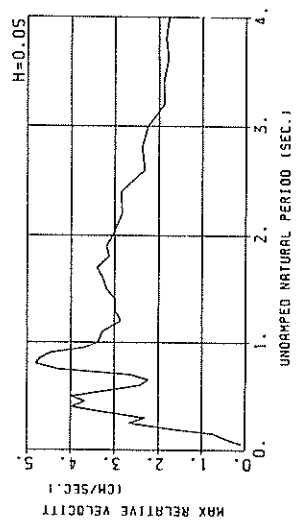
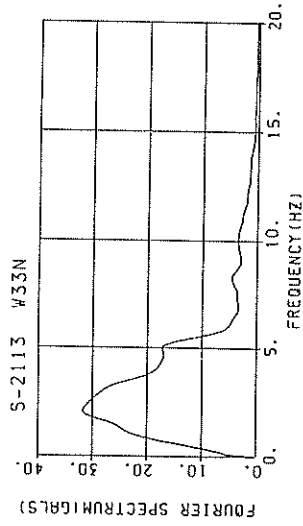
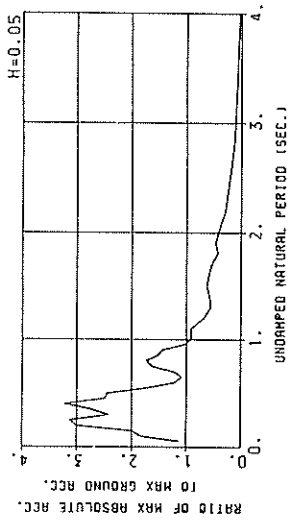

RESPONSE SPECTRA

FOURIER SPECTRA

RESPONSE SPECTRUM

RECORD = S-2113 COMPONENT = N33E SIGNAL = GR. ACC. CORRECTION = STATION = YAMASHITA-HEN-S
 DATE AND TIME = 1987-12-17-11-08 SAMPRING INTERVAL = 0.0100(SEC) MAX.GROUND ACC. = 115.12 (GAL)
 TIME LENGTH = 59.99 (SEC) SKIPPED LENGTH = 0.00 (SEC)

PER	DAMPING = 0.			DAMPING = 0.025			DAMPING = 0.050			DAMPING = 0.100			DAMPING = 0.250		
	AA	RV	RD	AA	RV	RD	AA	RV	RD	AA	RV	RD	AA	RV	RD
0.05	147.4	0.37	0.009	138.7	0.25	0.009	135.6	0.23	0.009	132.5	0.23	0.008	128.5	0.22	0.008
0.10	260.2	3.58	0.066	164.2	1.57	0.042	159.7	1.08	0.040	157.7	1.00	0.040	149.3	0.85	0.036
0.15	241.6	5.58	0.138	194.2	2.89	0.111	184.2	2.39	0.104	176.5	2.11	0.100	163.3	1.86	0.088
0.20	407.2	12.09	0.415	222.6	5.86	0.225	208.3	5.11	0.207	180.2	4.00	0.180	177.3	3.40	0.169
0.25	483.3	18.96	0.765	321.7	11.92	0.507	295.9	9.46	0.467	269.4	7.82	0.420	203.3	6.84	0.296
0.30	546.6	25.34	1.246	486.2	21.66	1.104	421.4	18.24	1.061	340.0	14.15	0.967	216.0	9.03	0.448
0.35	1149.6	64.09	3.567	558.3	30.65	1.733	468.1	24.79	1.450	350.5	18.75	1.067	201.8	10.57	0.559
0.40	1000.3	63.11	4.054	440.9	27.96	1.782	339.8	21.82	1.367	249.6	16.26	0.988	165.5	10.34	0.591
0.45	453.2	32.29	2.325	273.5	20.23	1.601	236.7	17.43	1.209	186.6	13.69	0.934	130.7	9.62	0.581
0.50	389.8	30.86	2.469	222.5	18.88	1.405	189.0	16.89	1.190	151.6	13.47	0.940	107.6	9.05	0.568
0.55	367.6	32.42	2.816	197.4	18.01	1.513	164.5	15.14	1.253	126.4	11.76	0.942	91.1	8.53	0.557
0.60	290.8	27.50	2.652	121.6	15.54	1.108	106.9	13.80	0.971	85.1	11.47	0.752	75.6	8.45	0.546
0.65	419.8	43.25	4.495	196.0	20.94	2.097	138.8	14.23	1.477	91.5	10.25	0.956	61.7	8.05	0.529
0.70	243.5	28.32	3.022	132.9	16.07	1.647	109.1	12.77	1.346	81.2	9.14	0.985	51.8	7.54	0.554
0.75	360.5	43.25	5.137	139.8	16.71	1.991	98.6	11.54	1.397	65.7	8.39	0.918	46.4	7.11	0.564
0.80	135.5	17.81	2.197	91.7	13.61	1.485	80.9	11.50	1.306	59.3	8.91	0.943	43.5	6.93	0.562
0.85	222.0	30.15	4.063	102.3	13.96	1.871	73.9	11.09	1.344	50.4	9.10	0.900	42.5	7.01	0.552
0.90	223.3	33.56	4.582	99.8	15.94	2.044	67.2	11.45	1.371	41.1	9.08	0.906	41.1	7.27	0.559
0.95	135.2	18.66	2.863	62.4	10.91	1.423	50.5	9.59	1.138	42.5	8.59	0.901	39.4	7.59	0.583
1.00	113.5	18.38	2.876	55.4	11.28	1.399	45.8	10.54	1.148	38.2	9.40	0.892	37.1	7.89	0.588
1.10	139.0	24.33	4.261	67.6	11.88	2.069	46.8	11.10	1.426	32.5	10.00	0.973	31.6	8.27	0.632
1.20	47.6	10.08	1.737	43.6	10.15	1.587	40.7	10.03	1.475	33.5	9.61	1.201	28.3	8.40	0.749
1.30	86.1	18.42	3.686	56.5	12.32	2.417	45.8	9.71	1.947	34.7	9.10	1.448	22.1	8.41	0.831
1.40	109.2	24.13	5.422	53.3	11.97	2.644	39.6	9.29	1.950	30.5	8.73	1.461	20.3	8.38	0.856
1.50	73.9	18.36	4.210	40.0	10.84	2.277	30.5	8.61	1.728	21.6	8.74	1.185	18.4	8.38	0.836
1.60	36.5	10.18	2.367	27.4	9.68	1.770	24.1	9.39	1.541	19.1	9.05	1.169	17.9	8.38	0.799
1.70	59.8	16.87	4.375	21.5	10.14	2.007	19.5	9.79	1.406	16.3	9.26	1.133	17.7	8.37	0.877
1.80	51.2	16.54	4.204	27.7	10.17	2.266	19.9	9.86	1.626	16.6	9.30	1.284	17.5	8.32	0.876
1.90	30.4	10.59	2.776	23.1	10.14	2.108	20.3	9.77	1.826	16.3	9.20	1.392	17.4	8.20	1.076
2.00	39.7	12.71	4.018	23.2	9.80	2.345	19.5	9.45	1.938	16.5	8.92	1.516	17.2	8.03	1.169
2.20	52.5	18.11	6.440	25.0	11.01	3.059	21.7	9.51	2.645	17.2	7.98	2.044	16.6	7.54	1.319
2.40	29.0	11.37	4.225	24.6	9.73	3.576	21.3	8.71	3.065	17.0	7.34	2.322	15.6	6.97	1.409
2.60	59.1	18.49	8.692	20.5	10.39	3.503	17.7	8.77	3.020	14.7	7.66	2.471	14.3	6.54	1.502
2.80	34.7	16.55	6.900	20.8	10.01	4.122	15.5	8.78	3.057	13.2	8.11	2.536	13.0	6.93	1.559
3.00	26.9	13.23	6.135	16.9	9.91	3.828	13.5	8.91	3.006	11.3	8.42	2.462	11.8	7.23	1.676
3.20	16.8	11.80	4.346	12.3	9.42	3.182	11.1	9.14	2.809	10.1	8.63	2.401	10.6	7.45	1.763
3.40	17.8	9.89	5.205	10.7	9.56	3.094	9.7	9.26	2.760	9.1	8.75	2.429	9.6	7.61	1.810
3.60	9.4	9.29	3.101	8.7	9.50	2.841	8.3	9.24	2.653	8.1	8.77	2.387	8.8	7.71	1.822
3.80	11.0	9.52	4.026	7.9	9.30	2.863	7.5	8.89	2.611	7.1	8.71	2.315	8.2	7.76	1.808
4.00	7.4	9.18	2.983	7.0	9.04	2.804	6.7	8.89	2.655	6.4	8.59	2.352	7.6	7.77	1.773

PER = PER100 (SEC) AA = ABSOLUTE ACC. (GAL) RV = RELATIVE VELOCITY (CM/SEC) RD = RELATIVE DISPLACEMENT (CM)

RESPONSE SPECTRUM

RECORD = S-2113 COMPONENT = W33N SIGNAL = GR. ACC. CORRECTION = STATION = YAMASHITA-HEN-S
 DATE AND TIME = 1987-12-17-11-08 SAMPRING INTERVAL = 0.0100(SEC) MAX. GROUND ACC. = 74.92 (GAL)
 TIME LENGTH = 59.99 (SEC) SKIPPED LENGTH = 0.00 (SEC)

PER	DAMPING = 0.			DAMPING = 0.025			DAMPING = 0.050			DAMPING = 0.100			DAMPING = 0.250		
	AA	RV	RD	AA	RV	RD	AA	RV	RD	AA	RV	RD	AA	RV	RD
0.05	89.6	0.24	0.006	86.9	0.21	0.006	85.9	0.21	0.005	84.9	0.20	0.005	82.8	0.19	0.005
0.10	270.4	4.12	0.069	151.2	1.69	0.058	158.2	1.43	0.035	123.2	1.12	0.031	104.4	0.81	0.025
0.15	160.3	3.56	0.091	128.7	2.87	0.073	101.1	2.17	0.057	104.8	1.60	0.060	104.3	1.46	0.055
0.20	418.7	12.65	0.424	280.1	7.71	0.282	218.4	6.07	0.220	164.4	4.48	0.165	105.8	2.55	0.098
0.25	425.1	16.94	0.673	250.3	9.66	0.396	197.6	7.74	0.313	155.3	5.84	0.243	113.7	3.58	0.168
0.30	1290.9	61.56	2.943	345.4	16.10	0.789	228.1	10.01	0.518	166.5	6.68	0.375	129.0	4.35	0.276
0.35	745.8	41.46	2.314	299.5	14.88	0.930	258.4	12.05	0.800	207.3	8.86	0.634	139.8	5.46	0.402
0.40	688.4	43.63	2.790	309.4	20.01	1.254	264.8	16.29	1.070	205.7	11.59	0.807	137.5	6.83	0.509
0.45	440.5	31.22	2.260	309.3	21.57	1.563	266.8	18.82	1.363	204.8	15.02	1.028	130.2	8.58	0.605
0.50	484.8	38.31	3.070	309.5	26.30	1.961	255.0	22.56	1.607	199.3	17.21	1.237	120.7	9.27	0.688
0.55	543.6	47.21	4.165	292.8	26.60	2.237	244.2	21.59	1.860	182.4	16.49	1.362	108.4	9.21	0.748
0.60	369.6	34.75	3.370	217.3	24.09	1.980	187.4	20.85	1.700	166.9	16.14	1.309	94.2	9.44	0.767
0.65	223.0	24.03	2.386	177.0	19.38	1.892	167.4	16.52	1.587	112.6	13.27	1.175	79.4	9.04	0.746
0.70	200.5	22.51	2.688	145.9	19.05	1.808	126.2	16.42	1.526	96.7	12.61	1.182	65.7	8.44	0.725
0.75	215.9	25.98	3.076	144.5	18.79	2.054	120.4	16.26	1.707	96.9	12.69	1.359	61.6	8.02	0.802
0.80	266.4	33.53	4.319	134.2	19.30	2.173	117.6	16.86	1.897	94.1	13.13	1.502	58.6	7.98	0.874
0.85	310.7	41.73	5.685	127.6	18.27	2.331	111.2	15.85	2.024	88.9	12.47	1.590	55.5	8.24	0.930
0.90	510.1	44.59	6.363	137.6	20.10	2.819	99.8	15.18	2.039	79.7	11.98	1.594	52.5	8.53	0.959
0.95	313.4	32.72	4.879	119.1	19.35	2.721	87.9	16.58	1.979	68.5	13.02	1.521	51.5	8.85	1.009
1.00	113.4	19.38	2.873	97.4	17.48	2.461	86.2	15.63	2.168	69.9	12.73	1.722	51.6	8.57	1.108
1.10	128.6	24.20	3.941	88.2	15.52	2.697	77.6	13.20	2.360	64.0	10.85	1.896	48.7	7.78	1.231
1.20	166.9	31.70	6.087	66.7	14.43	2.429	55.2	12.93	1.991	49.5	10.93	1.729	43.4	8.13	1.266
1.30	111.1	23.26	4.754	44.4	10.80	1.899	38.2	10.51	1.620	36.0	9.82	1.456	38.0	8.24	1.261
1.40	70.4	16.45	3.494	41.1	10.81	2.037	32.3	8.84	1.585	29.2	8.83	1.388	33.7	8.56	1.283
1.50	39.6	9.56	2.255	28.8	8.44	1.635	27.0	8.08	1.521	27.4	8.53	1.462	30.6	8.56	1.282
1.60	75.2	19.82	4.874	34.4	9.06	2.230	28.3	8.62	1.805	27.5	8.93	1.669	28.3	8.58	1.309
1.70	73.4	19.87	5.373	32.7	10.00	2.384	30.4	9.98	2.190	27.5	9.82	1.882	26.1	8.90	1.324
1.80	58.6	14.44	3.164	33.8	12.17	2.767	30.5	11.69	2.465	26.4	10.91	2.019	24.0	9.27	1.310
1.90	77.4	23.28	7.074	41.4	14.06	3.783	31.6	13.18	2.862	26.3	11.89	2.317	21.7	9.61	1.403
2.00	82.2	25.70	8.325	46.8	16.05	4.736	35.7	14.10	3.591	26.3	12.55	2.572	19.3	9.89	1.515
2.20	61.0	21.74	7.482	38.5	15.81	4.702	30.6	14.20	3.731	26.3	12.83	2.883	18.3	10.13	1.784
2.40	40.0	15.91	5.840	32.7	13.73	4.760	28.3	13.19	4.085	22.5	12.19	3.074	18.7	9.97	2.122
2.60	31.8	15.36	3.444	26.2	13.52	4.480	22.6	12.01	3.831	20.3	11.12	3.269	18.4	9.54	2.385
2.80	29.9	16.39	5.939	21.5	14.60	4.253	20.4	13.11	3.974	19.0	10.83	3.507	17.7	8.95	2.568
3.00	22.0	14.52	5.005	19.0	13.33	4.313	18.2	12.31	4.041	17.2	10.61	3.590	16.7	8.29	2.675
3.20	22.0	13.08	5.711	16.0	10.98	4.132	15.5	10.53	3.916	15.1	9.62	3.538	15.6	7.64	2.718
3.40	13.6	11.57	3.990	13.2	10.99	3.832	13.0	10.66	3.684	13.1	9.56	3.402	14.4	7.68	2.710
3.60	14.8	11.55	4.863	10.8	11.09	3.530	10.9	10.65	3.434	11.3	9.85	3.231	13.2	8.05	2.669
3.80	11.0	11.43	4.056	9.0	11.07	3.275	9.2	10.71	3.205	11.3	10.01	3.055	12.1	8.32	2.604
4.00	13.8	11.34	5.575	7.6	11.03	3.057	7.8	10.71	3.000	8.5	10.10	2.881	11.2	8.53	2.525

PER = PERIOD (SEC) AA = ABSOLUTE ACC. (GAL) RV = RELATIVE VELOCITY (CM/SEC) RD = RELATIVE DISPLACEMENT (CM)

RESPONSE SPECTRUM

RECORD = S-2113 COMPONENT = DOWN SIGNAL = GR. ACC. CORRECTION = STATION = YAMASHITA-HEN-S
 DATE AND TIME = 1987-12-17-11-08 SAMPRING INTERVAL = 0.0100(SEC) MAX-GROUND ACC. = 20.80 (GAL)
 TIME LENGTH = 59.99 (SEC) SKIPPED LENGTH = 0.00 (SEC)

PER	DAMPING = 0.			DAMPING = 0.025			DAMPING = 0.050			DAMPING = 0.100			DAMPING = 0.250		
	AA	RV	RD	AA	RV	RD	AA	RV	RD	AA	RV	RD	AA	RV	RD
0.05	36.3	0.17	0.002	23.1	0.06	0.001	22.9	0.06	0.001	22.8	0.05	0.001	22.7	0.05	0.001
0.10	164.1	2.56	0.042	46.1	0.57	0.012	38.1	0.42	0.010	34.2	0.35	0.009	29.3	0.23	0.007
0.15	229.0	5.34	0.131	50.3	1.01	0.029	41.6	0.73	0.024	34.0	0.58	0.009	29.3	0.42	0.017
0.20	108.1	3.28	0.109	71.4	2.12	0.072	62.4	1.78	0.063	47.8	1.30	0.047	34.6	0.78	0.035
0.25	183.8	6.94	0.291	91.5	3.58	0.145	65.0	2.65	0.103	46.8	1.92	0.073	32.0	1.05	0.046
0.30	116.1	5.38	0.265	69.1	3.18	0.158	50.3	2.30	0.114	36.0	1.65	0.080	29.2	1.21	0.060
0.35	158.7	7.58	0.430	75.9	4.18	0.235	56.9	3.24	0.176	42.3	2.48	0.129	29.3	1.43	0.085
0.40	281.5	17.79	1.141	90.5	5.38	0.366	67.1	3.99	0.271	47.7	2.84	0.190	30.4	1.54	0.112
0.45	192.2	13.68	0.986	77.3	5.49	0.396	51.4	3.67	0.282	40.9	2.98	0.206	28.5	1.74	0.129
0.50	172.2	13.49	1.090	71.1	5.67	0.450	50.7	3.99	0.319	34.3	2.85	0.213	24.8	1.78	0.135
0.55	118.7	10.44	0.909	44.0	3.91	0.337	35.4	3.17	0.270	27.7	2.51	0.208	21.0	1.71	0.137
0.60	133.1	12.47	1.213	36.1	3.41	0.329	25.1	2.43	0.227	20.6	2.07	0.185	18.4	1.64	0.141
0.65	172.7	17.52	0.778	28.4	2.91	0.303	22.6	2.21	0.21	20.3	1.97	0.214	16.9	1.61	0.151
0.70	105.2	11.63	1.305	29.1	3.17	0.381	25.3	2.65	0.333	20.8	2.33	0.254	15.9	1.67	0.164
0.75	152.4	18.11	2.172	46.3	5.75	0.659	33.7	4.30	0.478	23.1	3.06	0.323	14.8	1.81	0.175
0.80	162.6	20.70	2.635	53.5	6.99	0.865	36.0	4.81	0.560	22.9	3.27	0.366	13.4	1.91	0.184
0.85	97.8	9.07	1.222	40.9	5.86	0.746	31.5	4.70	0.573	22.4	3.13	0.400	12.1	1.97	0.191
0.90	97.0	14.01	1.989	41.1	5.96	0.842	29.7	4.47	0.605	19.4	3.13	0.387	11.0	2.02	0.199
0.95	93.6	14.05	2.140	28.8	4.59	0.557	21.9	3.71	0.498	16.4	2.89	0.367	10.6	2.03	0.203
1.00	62.4	10.23	1.580	23.7	4.13	0.598	18.7	3.37	0.469	15.5	2.59	0.384	10.5	2.01	0.256
1.10	39.4	7.01	1.207	24.0	4.29	0.735	18.9	3.27	0.574	14.3	2.33	0.429	9.7	1.89	0.257
1.20	34.7	6.27	1.267	16.0	3.07	0.582	13.9	2.85	0.502	11.5	2.31	0.408	9.1	1.72	0.271
1.30	29.0	6.36	1.243	14.5	3.95	0.622	11.4	2.99	0.466	10.0	2.24	0.404	8.6	1.72	0.286
1.40	40.7	9.33	2.021	15.0	3.85	0.745	11.9	2.98	0.588	8.9	2.21	0.430	7.9	1.81	0.289
1.50	21.2	5.56	1.210	17.1	3.99	0.922	13.0	3.19	0.733	8.9	2.28	0.493	7.0	1.88	0.295
1.60	35.3	8.94	2.287	17.4	4.56	1.126	12.1	3.27	0.719	8.4	2.44	0.518	6.2	1.91	0.305
1.70	33.5	9.21	2.452	15.9	4.65	1.162	11.0	3.41	0.804	7.4	2.48	0.513	5.6	1.92	0.300
1.80	20.3	6.06	1.662	11.4	3.58	0.938	8.7	3.14	0.709	6.8	2.48	0.539	5.0	1.88	0.322
1.90	18.3	5.50	1.675	13.2	4.15	1.207	9.6	3.19	0.873	6.3	2.31	0.554	4.9	1.81	0.343
2.00	37.2	11.94	3.768	13.0	4.34	1.311	8.6	3.04	0.867	5.8	2.34	0.563	4.6	1.71	0.353
2.20	15.0	5.53	1.843	7.3	3.64	0.898	5.9	2.84	0.716	4.8	2.16	0.547	4.0	1.72	0.347
2.40	9.1	4.44	1.521	6.2	3.46	0.905	4.8	2.87	0.700	3.5	2.07	0.482	3.4	1.72	0.321
2.60	8.0	3.44	1.363	3.9	2.69	0.668	3.6	2.31	0.602	3.1	2.07	0.478	2.9	1.78	0.300
2.80	5.0	2.85	1.000	3.0	2.59	0.591	2.6	2.38	0.509	2.3	2.08	0.416	2.6	1.76	0.292
3.00	3.3	2.69	0.733	2.6	2.42	0.581	2.2	2.25	0.484	1.7	2.03	0.371	2.3	1.73	0.282
3.20	2.9	2.32	0.758	2.0	2.06	0.527	1.8	1.88	0.455	1.5	1.76	0.367	2.0	1.73	0.273
3.40	1.8	2.18	0.558	1.5	2.01	0.425	1.3	1.88	0.374	1.2	1.76	0.328	1.8	1.72	0.264
3.60	1.8	1.89	0.593	1.3	1.81	0.412	1.1	1.77	0.355	1.0	1.76	0.297	1.7	1.71	0.255
3.80	1.3	2.03	0.463	0.9	1.90	0.322	0.9	1.83	0.277	0.9	1.77	0.273	1.6	1.70	0.245
4.00	1.2	1.75	0.485	0.8	1.76	0.316	0.7	1.75	0.267	0.7	1.74	0.253	1.5	1.70	0.235

PER = PERIOD (SEC) AA = ABSOLUTE ACC. (GAL) RV = RELATIVE VELOCITY (CM/SEC) RD = RELATIVE DISPLACEMENT (CM)

S-2113 YAMASHITA-HEN-S

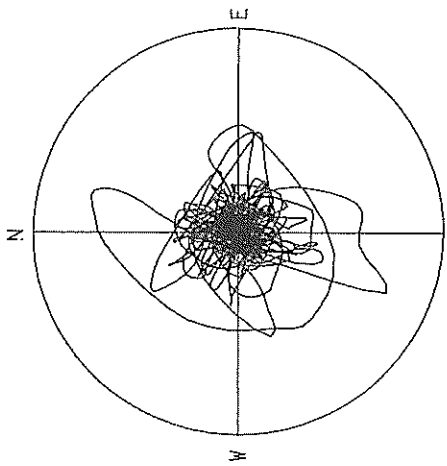

ACCELERATION
R=150.0GAL
MAX=117.2GAL

S-2113 YAMASHITA-HEN-S

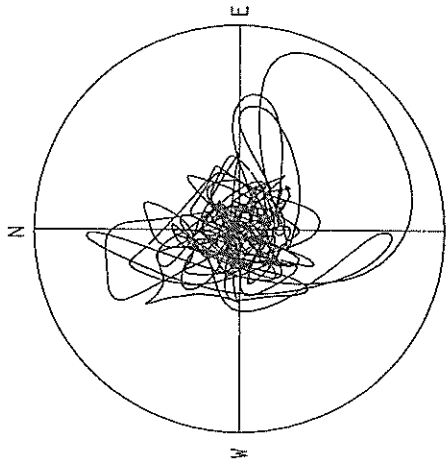

VELOCITY
R=9.0 CM/SEC.
MAX=8.4 CM/SEC.

S-2113 YAMASHITA-HEN-S

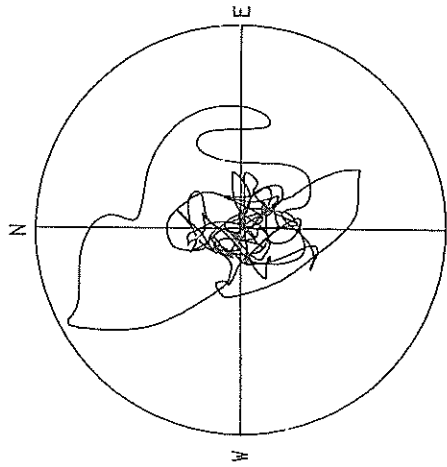

DISPLACEMENT
R=2.00 CM
MAX=1.92 CM

RECORD NUMBER
STATION

M-1183
YAMASHITA-HEN-M

EARTHQUAKE DATA

 DATA AND TIME
 LOCATION OF HYPOCENTER
 EPICENTRAL REGION
 LATITUDE
 LONGITUDE
 DEPTH
 MAGNITUDE

11: 8 DEC.17,1987

CHIBA-KEN-TOHO-OKI
 35°22' N
 140°30' E
 58KM
 6.7

PEAK VALUES OF COMPONENTS

 N S E W U D HORIZONTAL*

PARAMETER OF THE VARIABLE FILTER

FC (HZ)	0.220	0.220	0.391		
MAXIMUM ACCELERATION (GAL)					
SMAC-B2 EQUIVALENT	119.3	70.3	17.2	135.2	
ORIGINAL	140.2	86.1	23.4	160.7	
CORRECTED	142.1	85.7	23.7	161.1	
MAXIMUM VELOCITY (CM/SEC)					
FIXED FILTER	9.92	10.68	2.08	13.20	
VARIABLE FILTER	7.89	9.79	1.51	11.42	
MAXIMUM DISPLACEMENT (CM)					
FIXED FILTER	2.467	2.805	0.709	3.298	
VARIABLE FILTER	1.401	2.195	0.192	2.453	

* RESULTANT OF HORIZONTAL COMPONENTS

M-1183 YAMASHITA-HEN-M

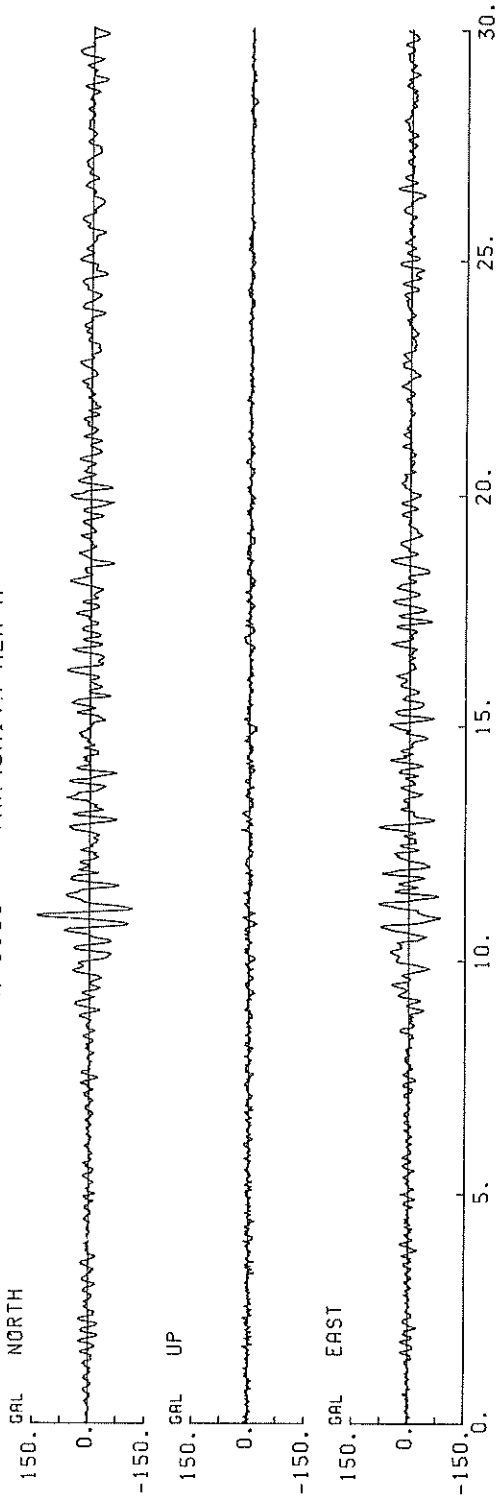

TIME (SECONDS)

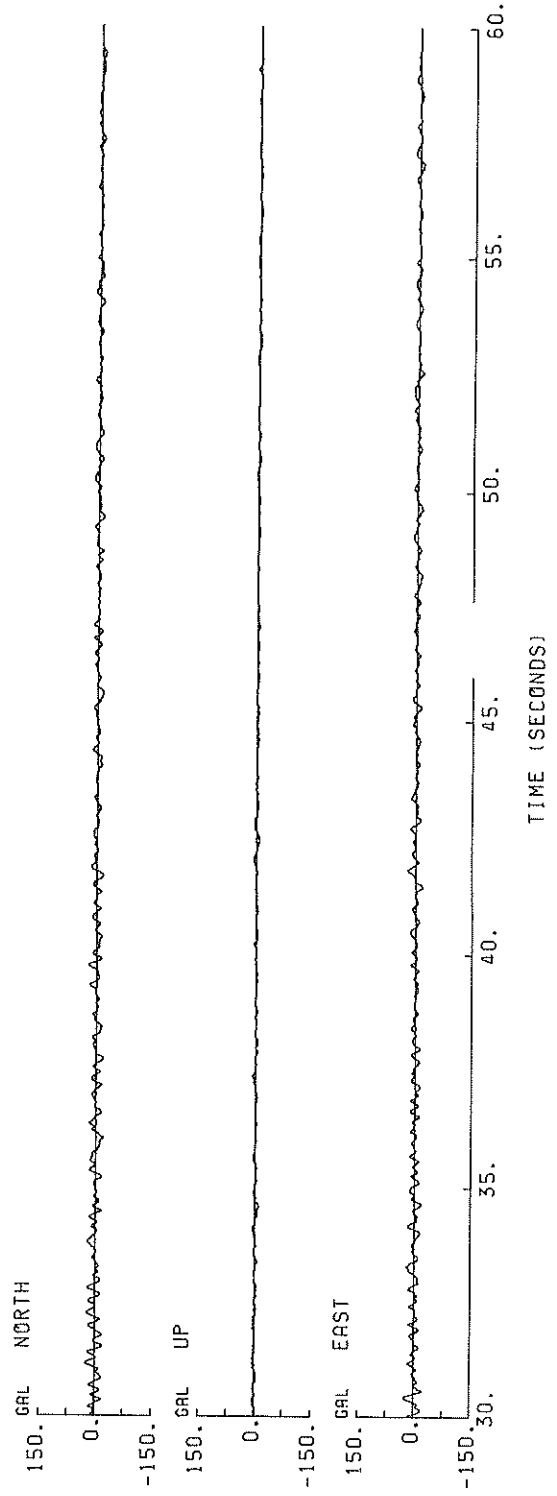

TIME (SECONDS)

M-1183 NORTH YAMASHITA-HEN-M

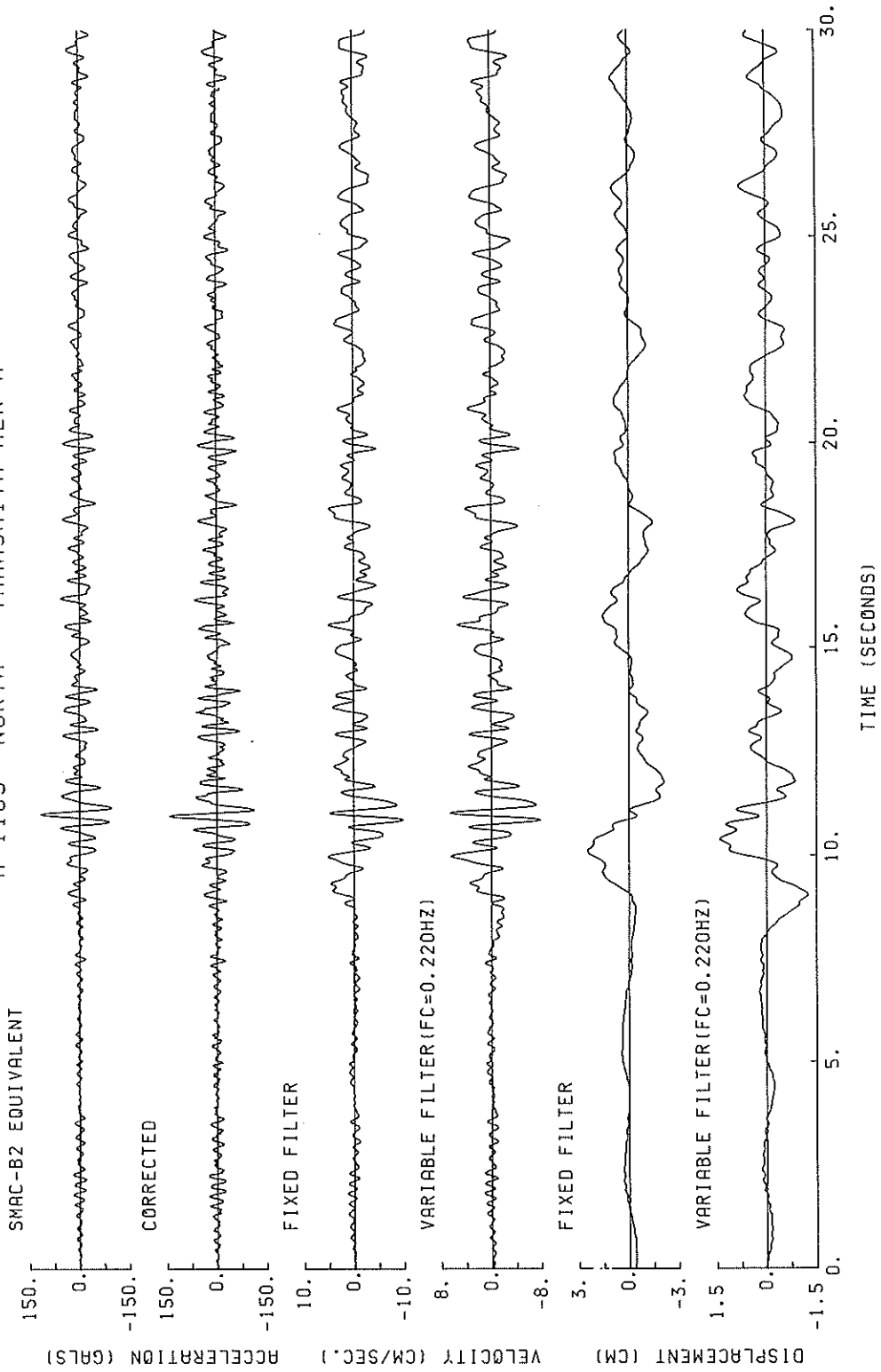

M-1183 NORTH YAMASHITA-HEN-M

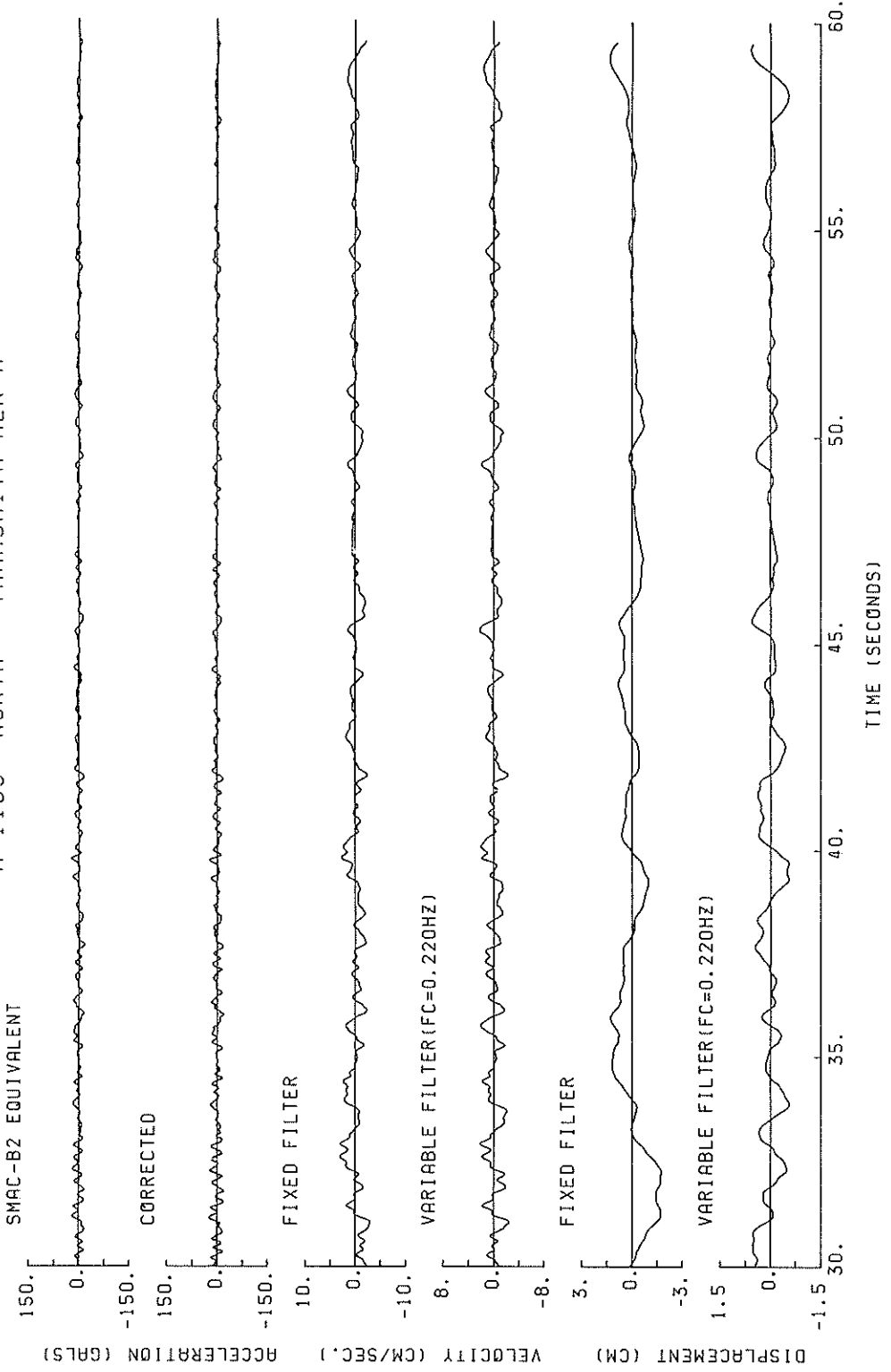

M-1183 EAST YAMASHITA-HEN-M

SMAC-B2 EQUIVALENT

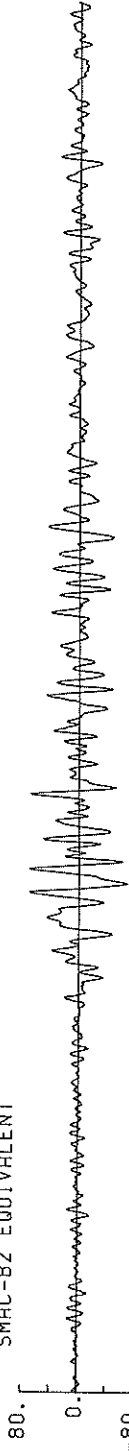

CORRECTED



FIXED FILTER

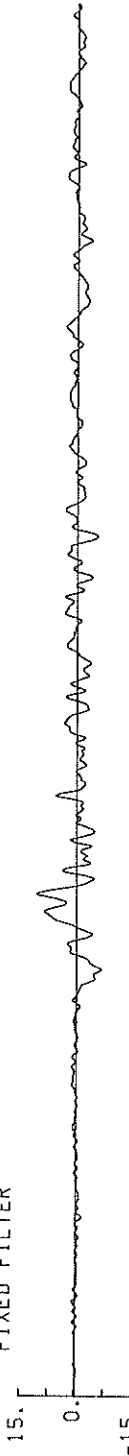

VARIABLE FILTER (FC=0.220HZ)

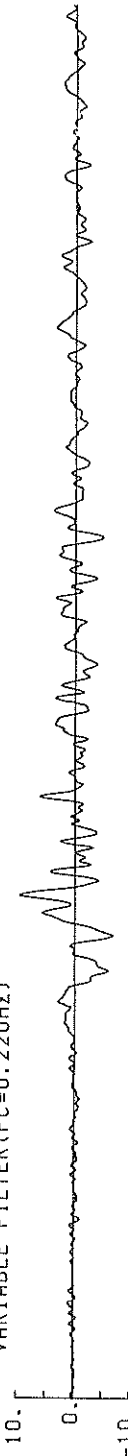

FIXED FILTER

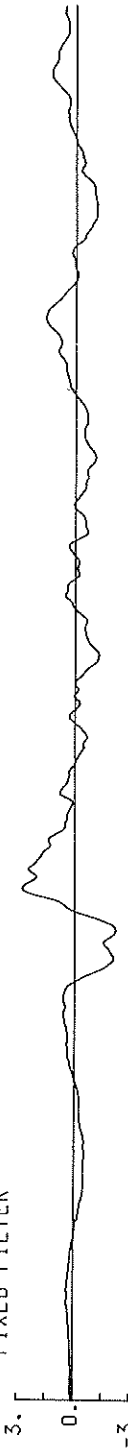

VARIABLE FILTER (FC=0.220HZ)



0. 5. 10. 15. 20. 25. 30.
TIME (SECONDS)

M-1183 EAST YAMASHITA-HEN-M

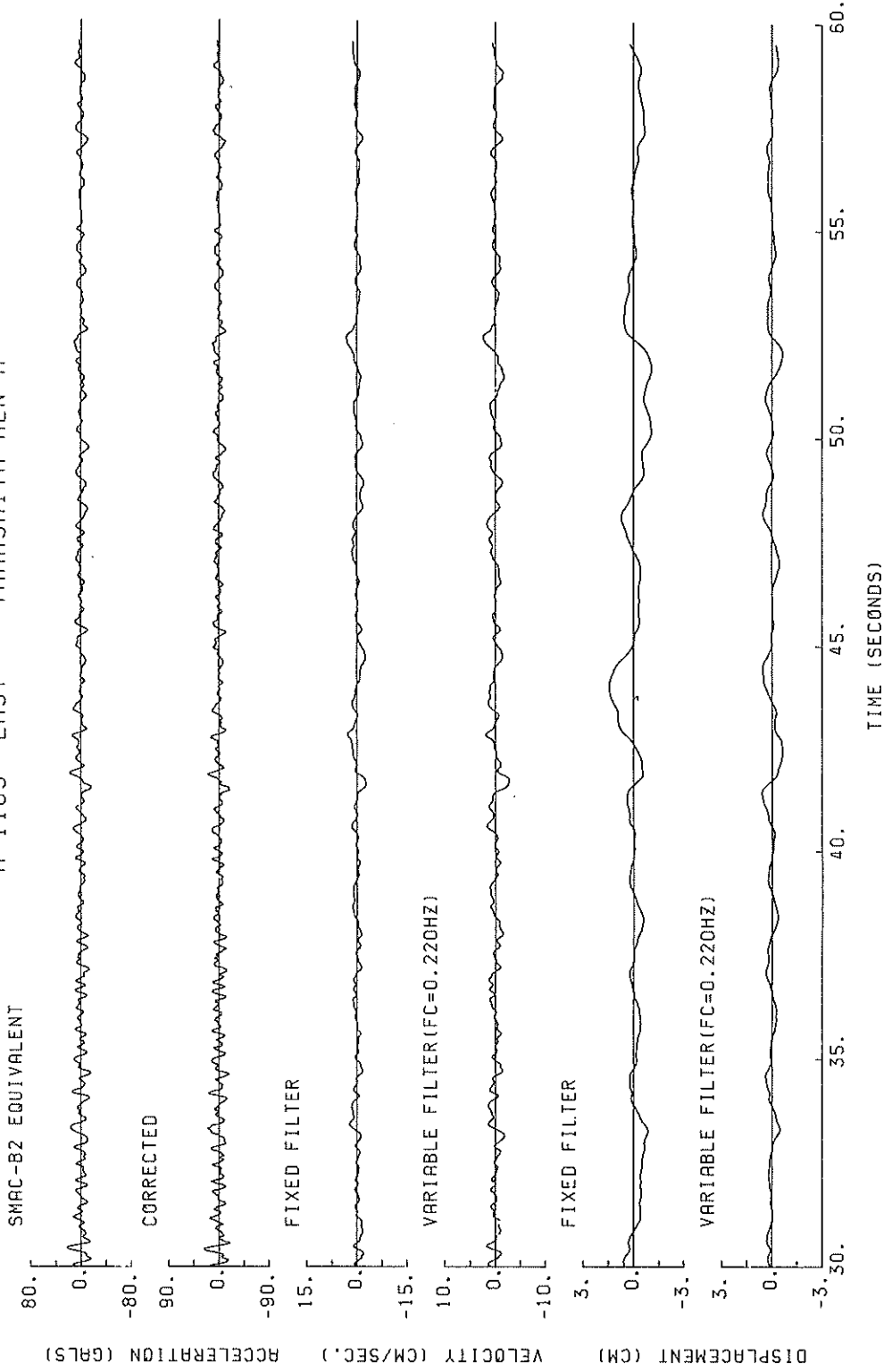

M-1183 UP YAMASHITA-HEN-M

SMAC-B2 EQUIVALENT

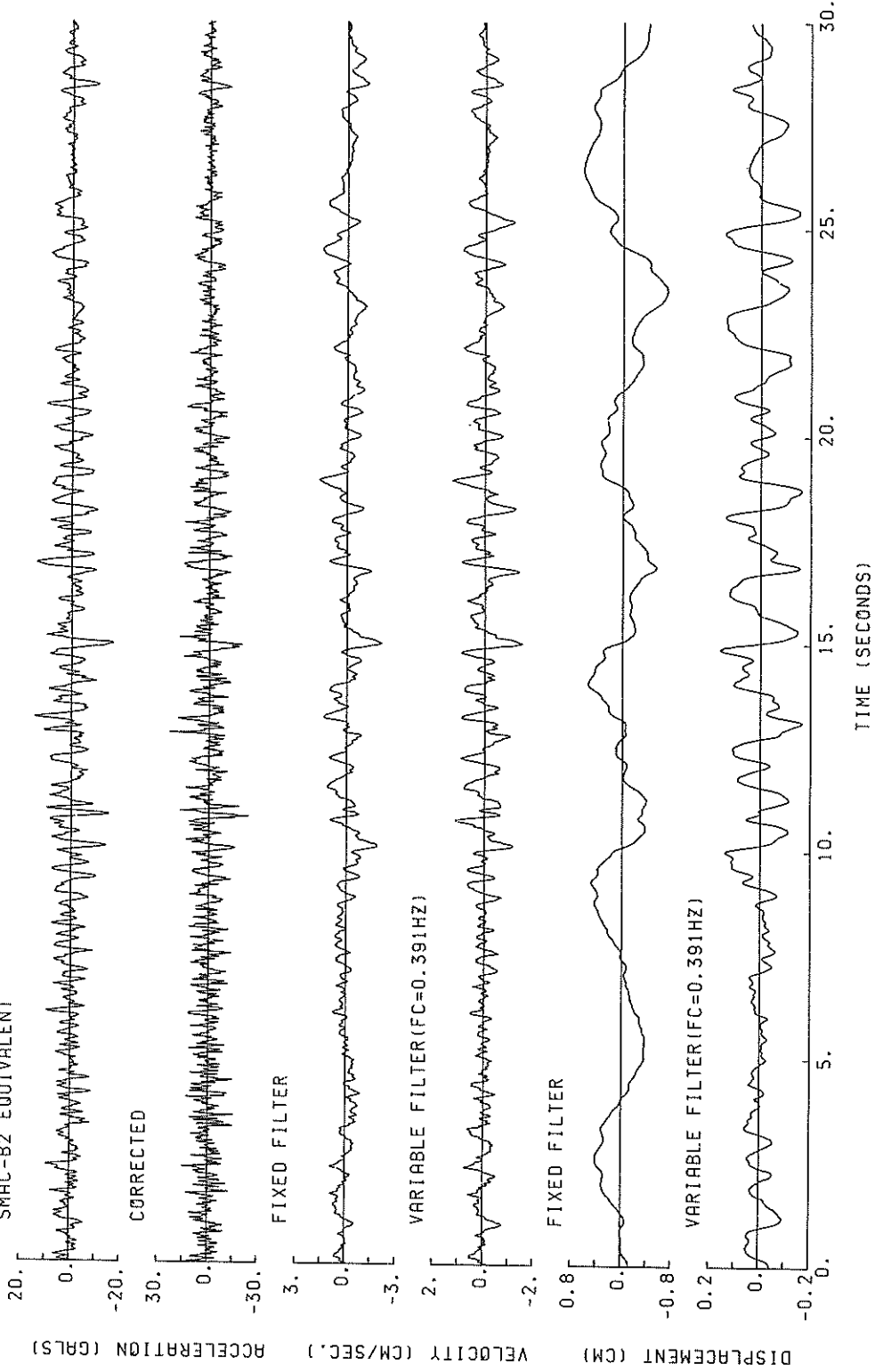

M-1183 UP YAMASHITA-HEN-M

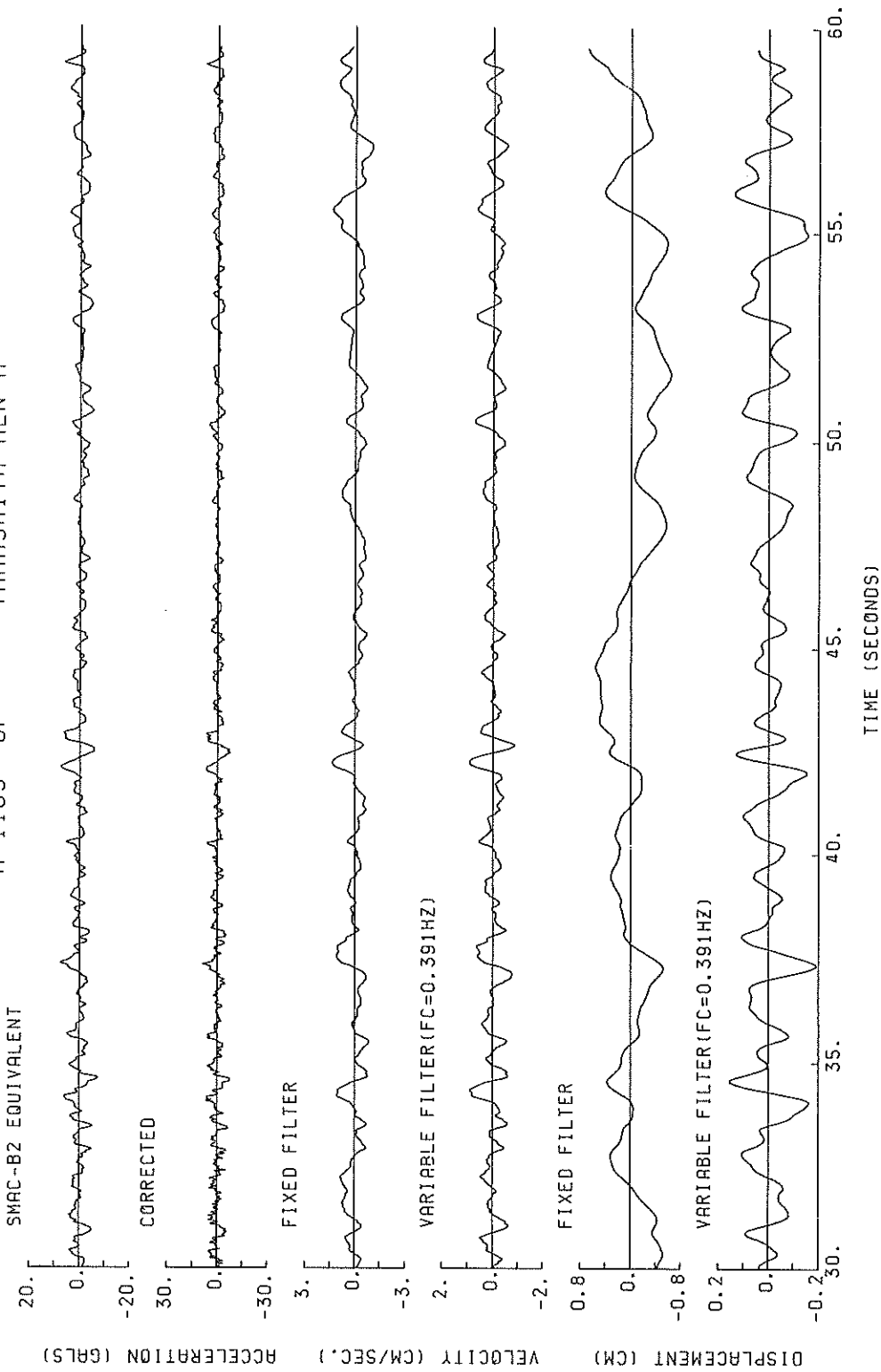

M-1163 NORTH YAMASHITA-HEN-M
(1/FC=4.54 SEC.)

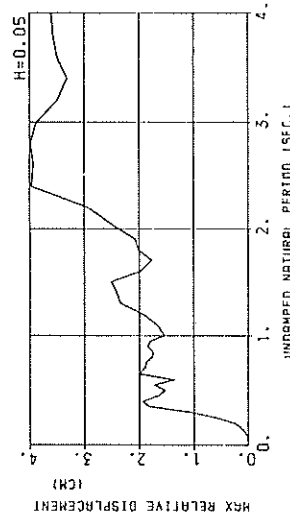
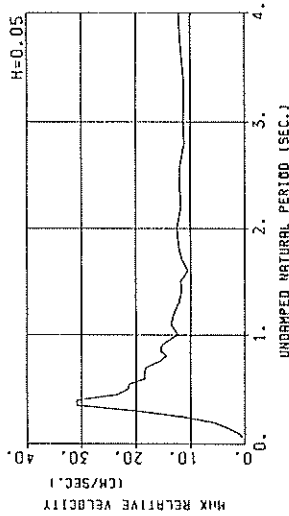
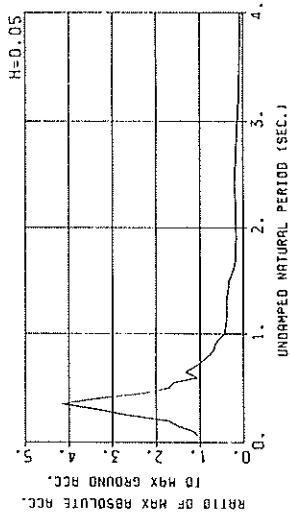

RESPONSE SPECTRA

M-1183 EAST YAMASHITA-HEN-M
(1/FC=4.55 SEC.)

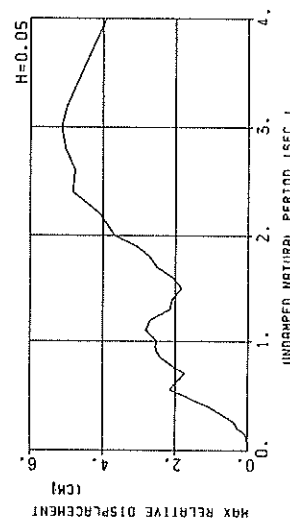
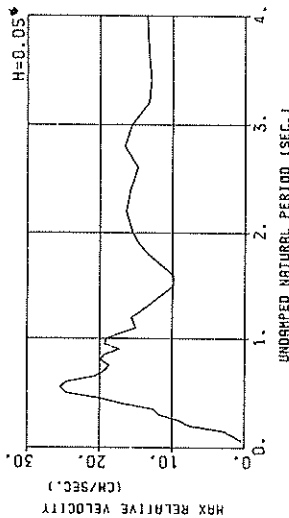
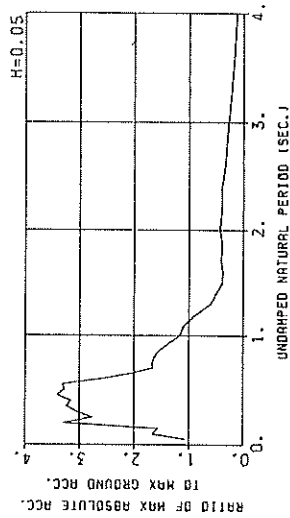

RESPONSE SPECTRA

M-1183 UP YAMASHITA-HEN-M
(1/FC=2.58 SEC.)

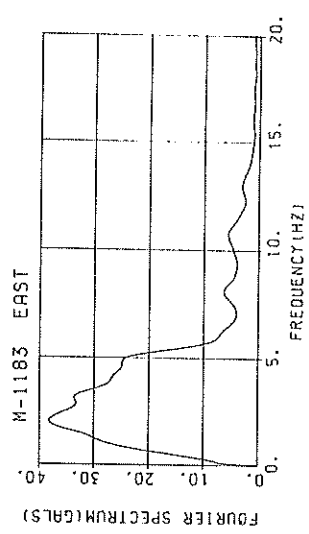
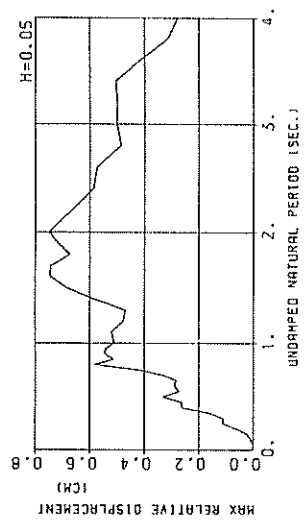
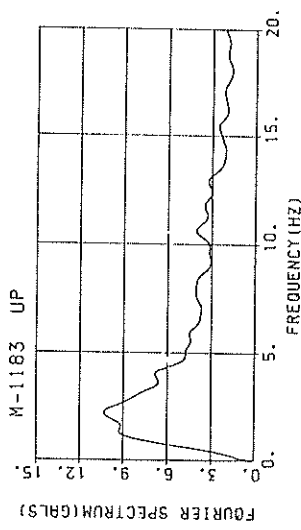
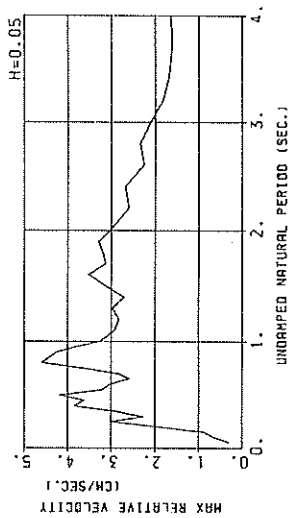
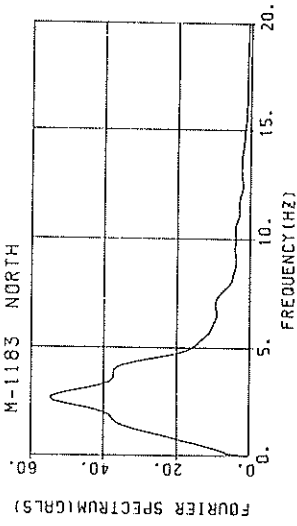
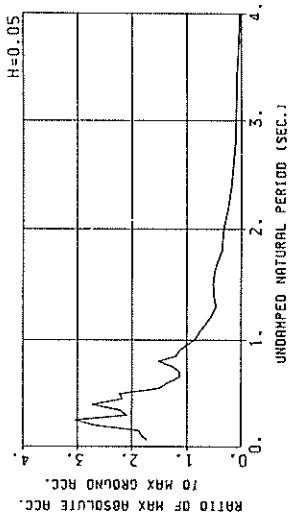

RESPONSE SPECTRA

FOURIER SPECTRA

RESPONSE SPECTRUM

RECORD = H-1183 COMPONENT = NORTH SIGNAL = GR. ACC. CORRECTION = MAX. GROUND ACC. = 142.09 (GAL) STATION = YAMASHITA-HEN-H
 DATE AND TIME = 1987-12-17-11-08 SAMPRING INTERVAL = 0.0100(SEC) SKIPPED LENGTH = 0.00 (SEC) MAX. GROUND ACC. = 142.09 (GAL)

PER	DAMPING = 0.			DAMPING = 0.025			DAMPING = 0.050			DAMPING = 0.100			DAMPING = 0.250		
	AA	RV	RD	AA	RV	RD	AA	RV	RD	AA	RV	RD	AA	RV	RD
0.05	176.0	0.50	0.011	147.0	0.32	0.009	148.5	0.30	0.009	147.7	0.26	0.009	144.7	0.20	0.009
0.10	507.7	7.75	0.129	159.5	1.71	0.040	161.9	1.23	0.041	165.7	0.84	0.042	163.0	0.77	0.041
0.15	632.5	14.78	0.260	234.2	3.94	0.134	214.5	3.35	0.122	195.9	2.87	0.120	177.5	2.04	0.094
0.20	608.5	17.77	0.215	259.8	6.69	0.283	244.4	5.83	0.287	211.9	4.52	0.214	193.0	3.83	0.188
0.25	980.0	38.76	1.551	421.7	15.52	0.669	385.0	11.96	0.767	321.2	9.91	0.505	233.8	6.95	0.344
0.30	646.1	50.78	1.473	514.1	22.06	1.169	471.6	19.72	1.076	398.6	16.12	0.894	260.0	10.39	0.543
0.35	1441.9	80.79	4.474	687.1	37.40	2.136	590.1	30.88	1.826	447.5	23.30	1.362	253.6	12.88	0.709
0.40	1159.1	74.50	4.698	641.4	40.85	2.600	481.3	30.87	1.944	371.5	22.40	1.379	214.7	13.21	0.771
0.45	719.6	51.33	3.691	361.6	27.02	1.955	322.7	23.59	1.643	252.0	18.46	1.262	170.4	12.44	0.765
0.50	504.3	39.59	3.193	273.1	23.34	1.726	242.3	21.59	1.524	199.5	17.77	1.240	137.8	11.65	0.750
0.55	389.7	33.06	2.986	275.0	25.71	2.106	227.1	21.25	1.729	171.9	16.10	1.287	115.7	11.36	0.745
0.60	427.5	40.48	3.898	179.1	20.92	1.627	150.4	18.40	1.360	120.0	15.15	1.059	95.9	11.15	0.728
0.65	694.8	72.27	7.436	252.5	45.73	2.699	188.7	18.51	2.007	124.1	14.30	1.295	78.1	10.64	0.701
0.70	503.4	55.99	6.248	211.4	24.62	2.618	153.7	18.10	1.897	106.6	13.05	1.293	67.7	9.76	0.700
0.75	383.9	45.30	5.470	175.1	21.06	2.493	132.0	15.61	1.871	90.5	12.26	1.264	60.0	8.92	0.723
0.80	220.8	28.15	3.579	125.5	16.79	2.033	109.0	14.34	1.758	80.3	11.25	1.278	52.8	8.36	0.724
0.85	288.6	39.31	5.282	126.4	18.56	2.309	96.3	15.51	1.752	68.1	11.77	1.207	48.8	8.55	0.738
0.90	360.5	52.07	7.596	130.6	20.20	2.677	90.5	15.21	1.846	62.6	11.67	1.238	46.8	8.68	0.745
0.95	205.1	30.73	4.688	105.0	17.55	2.396	79.1	13.97	1.794	57.9	11.68	1.292	46.1	8.72	0.784
1.00	130.1	20.42	3.296	66.8	13.16	1.687	61.0	12.25	1.531	51.1	10.75	1.253	44.6	9.13	0.807
1.10	191.8	33.85	5.878	81.5	14.73	2.496	54.8	13.53	1.671	39.9	11.96	1.187	34.6	9.81	0.807
1.20	82.5	15.89	3.011	58.0	13.51	2.111	53.5	13.03	1.937	41.0	12.02	1.468	33.7	10.12	0.917
1.30	109.1	21.97	4.669	63.4	14.36	2.709	54.9	12.12	2.337	42.7	11.38	1.786	28.4	10.16	1.020
1.40	154.3	35.12	7.662	65.7	13.85	3.257	49.0	11.67	2.411	38.6	10.52	1.850	25.0	10.11	1.055
1.50	169.1	39.52	9.637	67.1	16.13	3.819	44.3	11.81	2.507	29.0	10.14	1.578	22.1	10.08	1.022
1.60	53.9	13.31	3.494	36.5	10.45	2.357	30.8	10.45	1.972	23.5	10.48	1.439	20.5	10.12	0.955
1.70	69.6	19.41	5.097	32.6	12.01	2.385	24.3	11.55	1.769	19.8	11.03	1.389	20.0	10.19	0.956
1.80	62.4	18.30	5.122	34.6	12.39	2.833	24.7	12.02	2.013	19.7	11.39	1.534	19.9	10.23	1.076
1.90	50.4	16.31	4.606	28.1	12.73	2.564	23.0	12.31	2.089	19.7	11.57	1.696	19.9	10.22	1.210
2.00	36.1	13.79	3.660	27.4	13.04	2.364	23.0	12.46	2.380	19.1	11.59	1.801	20.0	10.14	1.348
2.20	63.7	23.24	7.804	31.4	12.92	3.838	24.1	11.62	2.946	19.6	10.93	2.340	19.9	9.74	1.602
2.40	37.6	15.81	5.489	31.9	13.38	4.643	27.5	11.92	3.969	21.5	9.84	2.996	19.3	9.10	1.789
2.60	48.9	20.39	8.380	34.2	13.51	4.648	23.3	11.84	3.942	18.7	9.46	3.079	18.2	8.36	1.880
2.80	51.8	24.96	10.281	25.7	13.27	5.085	20.3	11.09	3.986	16.2	10.07	3.222	16.8	8.39	1.920
3.00	50.1	17.56	6.865	21.8	13.31	4.948	17.4	11.30	3.681	14.2	10.50	3.109	15.3	8.86	2.025
3.20	23.4	16.00	6.077	17.0	13.00	4.400	13.6	11.15	3.496	12.4	10.65	2.929	13.9	9.21	2.161
3.40	23.8	14.36	6.973	12.5	11.35	3.318	11.7	11.22	3.318	11.4	10.81	3.023	12.6	9.47	2.248
3.60	13.7	12.08	4.509	11.5	11.82	3.738	11.0	11.55	3.502	10.6	11.04	3.107	11.4	9.67	2.292
3.80	14.8	12.81	5.415	10.7	12.32	3.880	10.1	11.91	3.575	9.7	11.24	3.115	10.3	9.80	2.292
4.00	11.1	13.10	4.492	9.9	12.52	4.001	9.2	12.04	3.604	8.6	11.31	3.002	9.6	9.88	2.252

PER = PERIOD (SEC) AA = ABSOLUTE ACC. (GAL) RV = RELATIVE VELOCITY (CM/SEC) RD = RELATIVE DISPLACEMENT (CM)

RESPONSE SPECTRUM

RECORD = M-1183 COMPONENT = EAST SIGNAL = GR. ACC. CORRECTION = STATION = YAMASHITA-HEN-M
 DATE AND TIME = 1987-12-17-11-08 SAMPLING INTERVAL = 0.0100(SEC) MAX. GROUND ACC. = 85.66 (GAL)
 TIME LENGTH = 59.49 (SEC) SKIPPED LENGTH = 0.00 (SEC)

PER	DAMPING = 0.				DAMPING = 0.025				DAMPING = 0.050				DAMPING = 0.100				DAMPING = 0.250			
	AA	RV	RD	AA	RV	RD	AA	RV	RD	AA	RV	RD	AA	RV	RD	AA	RV	RD		
0.05	160.6	1-10	0.010	95.2	0.27	0.006	89.1	0.23	0.006	88.1	0.22	0.006	88.1	0.20	0.006	88.1	0.20	0.006		
0.10	472.0	7-20	0.120	167.1	1.92	0.042	142.1	1.43	0.036	121.0	0.99	0.030	105.3	0.81	0.025	105.3	0.81	0.025		
0.15	297.8	6-54	0.170	158.6	3.53	0.090	133.9	2.88	0.076	110.6	2.16	0.062	114.8	1.56	0.061	114.8	1.56	0.061		
0.20	1027.3	32-56	1-041	389.2	11.07	0.395	281.9	7.61	0.286	196.7	5.19	0.196	126.6	2.95	0.120	126.6	2.95	0.120		
0.25	784.8	30-31	1-242	321.7	12.93	0.508	236.7	9.18	0.375	184.0	6.67	0.287	131.2	4.09	0.193	131.2	4.09	0.193		
0.30	1089.0	51-71	2-483	395.0	18.21	0.900	260.5	11.82	0.591	187.8	7.94	0.420	138.0	5.07	0.296	138.0	5.07	0.296		
0.35	1104.0	61-28	3-426	313.3	16.58	0.969	277.7	12.64	0.857	224.3	9.70	0.686	151.6	6.01	0.434	151.6	6.01	0.434		
0.40	566.8	36.80	2-297	323.5	22.00	1.310	270.4	16.91	1.090	211.3	12.00	0.842	149.8	7.33	0.554	149.8	7.33	0.554		
0.45	477.8	36.09	2-451	344.9	24.36	1.764	292.1	20.10	1.488	223.9	16.06	1.120	141.7	9.39	0.661	141.7	9.39	0.661		
0.50	420.8	35-06	2-665	332.8	27.96	2-108	280.9	24.61	1-771	220.0	19.09	1-365	135.1	10.43	0.755	135.1	10.43	0.755		
0.55	822.4	71-91	6-301	360.5	32.32	2-762	283.1	25.47	2-157	211.5	18.58	1-582	123.2	10.26	0.829	123.2	10.26	0.829		
0.60	411.8	39-35	3-755	267.9	28.59	2-441	224.4	24.59	2-033	189.6	19.03	1-515	105.2	10.97	0.869	105.2	10.97	0.869		
0.65	298.4	30-65	3-194	204.3	23.67	2-181	176.6	20.59	1-879	136.9	16.40	1-427	90.8	10.74	0.863	90.8	10.74	0.863		
0.70	248.0	27-21	3-078	163.2	22.39	2-024	141.4	19.27	1-743	109.9	14.94	1-342	76.2	10.02	0.854	76.2	10.02	0.854		
0.75	214.7	25-64	3-060	170.5	21.58	2-426	142.2	18.69	2-012	113.0	14.67	1-585	73.3	9.42	0.954	73.3	9.42	0.954		
0.80	262.5	34-67	4-255	156.7	22.82	2-537	138.4	19.86	2-234	111.4	15.53	1-778	70.5	9.22	1-049	70.5	9.22	1-049		
0.85	503.3	68-56	9-212	153.8	22.01	2-809	132.9	17.32	2-418	107.2	15.12	1-926	67.1	9.41	1-132	67.1	9.41	1-132		
0.90	296.6	42-52	6-085	143.4	21.35	2-940	123.2	17.33	2-512	99.4	13.76	1-900	64.2	9.74	1-185	64.2	9.74	1-185		
0.95	335.1	50-44	7-660	165.4	25.50	3-776	112.3	19.26	2-553	87.8	14.82	1-953	60.3	9.95	1-205	60.3	9.95	1-205		
1.00	144.7	26-03	3-665	115.6	21.94	2-923	99.6	19.12	2-506	78.5	15.11	1-941	57.6	9.95	1-247	57.6	9.95	1-247		
1.10	174.9	30-61	5-361	103.6	16.87	3-169	92.7	15.04	2-819	76.3	12.71	2-266	56.0	9.20	1-427	56.0	9.20	1-427		
1.20	170.7	34-38	6-225	84.7	17.93	3-083	74.3	15.64	2-682	62.7	12.74	2-191	50.8	8.95	1-495	50.8	8.95	1-495		
1.30	139.4	30-23	5-578	60.8	14.48	2-601	50.5	13.50	2-151	45.2	11.85	1-832	44.6	9.20	1-494	44.6	9.20	1-494		
1.40	139.4	30-73	6-923	54.4	14.18	2-697	42.0	11.66	2-074	35.0	10.50	1-683	39.4	9.25	1-493	39.4	9.25	1-493		
1.50	39.8	10-68	2-266	34.6	10.32	1-969	32.5	9.89	1-827	31.6	9.93	1-683	35.5	9.35	1-490	35.5	9.35	1-490		
1.60	68.0	38-6	3-929	38.6	10.94	2-502	32.3	9.89	2-058	31.5	10.28	1-908	32.5	9.66	1-507	32.5	9.66	1-507		
1.70	58.0	16-74	4-246	40.0	11.75	2-922	34.9	11.59	2-511	31.3	11.28	2-138	29.9	10.08	1-514	29.9	10.08	1-514		
1.80	81.1	20-98	5-834	37.1	14.44	3-040	33.7	13.43	2-724	29.6	12.45	2-256	27.4	10.52	1-490	27.4	10.52	1-490		
1.90	80.5	24-60	7-365	42.3	15.43	3-860	34.1	14.68	3-086	29.0	13.43	2-548	24.7	10.94	1-591	24.7	10.94	1-591		
2.00	102.3	33-42	10-367	50.2	17.57	5-069	36.9	15.52	3-694	29.0	14.13	2-816	22.6	11.29	1-725	22.6	11.29	1-725		
2.20	98.0	34-96	12-012	44.2	18.71	5-415	33.6	16.43	4-083	27.8	14.81	3-293	22.1	11.65	2-167	22.1	11.65	2-167		
2.40	40.8	18-82	7-012	39.0	16.63	5-678	33.6	15.84	4-837	26.4	14.44	3-663	22.6	11.57	2-591	22.6	11.57	2-591		
2.60	48.0	18-96	6-979	33.2	16.66	5-675	28.1	14.79	4-775	25.0	13.34	4-046	22.4	11.12	2-936	22.4	11.12	2-936		
2.80	41.8	21-06	8-301	28.1	18.58	5-559	25.9	16.58	5-050	23.7	13.59	4-410	21.6	10.43	3-183	21.6	10.43	3-183		
3.00	40.3	19-50	9-183	24.4	16.99	5-521	23.1	15.59	5-150	21.5	13.34	4-561	20.5	9.60	3-350	20.5	9.60	3-350		
3.20	35.0	18-01	9-074	20.4	13.85	5-259	19.7	13.25	4-981	19.0	12.01	4-584	19.1	8.23	3-391	19.1	8.23	3-391		
3.40	20.2	15-49	5-921	16.9	10.94	4-914	16.6	12.93	4-714	16.5	11.81	4-325	17.6	9.44	3-384	17.6	9.44	3-384		
3.60	22.2	14-32	7-274	14.1	13.57	4-608	14.0	13.23	4-445	14.2	12.23	4-128	16.2	9.92	3-326	16.2	9.92	3-326		
3.80	14.9	14-39	5-462	11.9	13.90	4-333	11.8	13.52	4-183	12.3	12.50	3-909	14.8	10.28	3-235	14.8	10.28	3-235		
4.00	15.3	14-48	6-184	10.1	13.99	4-068	10.0	13.53	3-901	10.6	12.66	3-667	13.6	10.55	3-118	13.6	10.55	3-118		

PER = PERIOD (SEC) AA = ABSOLUTE ACC. (GAL) RV = RELATIVE VELOCITY (CM/SEC) RD = RELATIVE DISPLACEMENT (CM)

RESPONSE SPECTRUM

RECORD = R-1183 COMPONENT = UP SIGNAL = GR. ACC. CORRECTION = STATION = YAMASHITA-HEN-H
 DATE AND TIME = 1987-12-17-11-08 SAMPRING INTERVAL = 0.0100(SEC) MAX-GROUND ACC. = 23.74 (GAL)
 TIME LENGTH = 59.49 (SEC) SKIPPED LENGTH = 0.00 (SEC)

PER	DAMPING = 0.025			DAMPING = 0.050			DAMPING = 0.100			DAMPING = 0.250					
	AA	RV	RD	AA	RV	RD	AA	RV	RD	AA	RV	RD			
0.05	414.5	3.28	0.026	49.4	0.36	0.003	40.4	0.26	0.003	32.6	0.18	0.002	28.1	0.11	0.002
0.10	207.1	3.30	0.052	59.5	0.90	0.015	43.4	0.64	0.011	36.6	0.48	0.009	28.9	0.31	0.007
0.15	275.5	6.48	0.157	56.3	1.30	0.032	44.9	0.89	0.025	36.3	0.66	0.020	28.5	0.40	0.015
0.20	134.2	4.24	0.136	79.9	2.47	0.081	63.2	1.88	0.064	47.4	1.30	0.047	31.5	0.72	0.030
0.25	294.1	11.65	0.466	107.9	4.42	0.171	72.1	3.01	0.113	46.6	1.99	0.072	29.4	1.09	0.043
0.30	201.0	9.41	0.458	88.3	3.15	0.155	49.6	2.26	0.113	36.2	1.58	0.082	26.3	1.19	0.058
0.35	171.1	9.45	0.531	84.1	3.58	0.198	53.3	2.89	0.164	37.5	2.31	0.114	28.8	1.43	0.083
0.40	172.8	10.86	0.700	81.2	4.93	0.328	64.8	3.85	0.262	45.7	2.73	0.182	30.1	1.48	0.111
0.45	141.6	10.07	0.726	82.3	5.66	0.422	51.7	3.62	0.264	39.9	2.98	0.196	28.3	1.77	0.129
0.50	219.5	17.10	1.390	70.1	5.46	0.444	52.8	4.20	0.532	33.6	2.79	0.209	24.8	1.80	0.156
0.55	86.6	7.49	0.664	48.4	4.40	0.371	35.6	3.21	0.272	27.2	2.51	0.204	21.1	1.69	0.137
0.60	94.3	9.29	0.860	45.2	4.18	0.411	31.8	3.03	0.288	22.7	2.33	0.203	18.3	1.59	0.141
0.65	92.1	9.33	0.985	33.6	3.28	0.359	26.6	2.58	0.283	20.6	2.10	0.217	16.7	1.55	0.150
0.70	65.6	7.47	0.814	31.3	3.47	0.388	26.6	2.84	0.329	20.9	2.17	0.254	15.9	1.62	0.165
0.75	71.1	8.13	1.014	38.5	4.65	0.548	29.5	3.61	0.419	21.8	2.53	0.303	15.0	1.74	0.180
0.80	110.3	14.05	1.788	53.5	7.14	0.867	36.0	4.59	0.581	22.0	2.96	0.348	13.8	1.86	0.188
0.85	83.0	11.22	1.519	37.4	5.73	0.684	28.2	4.43	0.513	19.6	3.03	0.350	12.2	1.91	0.187
0.90	122.9	17.47	2.521	35.6	5.59	0.730	26.7	4.25	0.544	17.9	2.98	0.359	10.8	1.89	0.194
0.95	77.0	11.65	1.761	32.6	5.19	0.745	23.8	3.83	0.542	17.1	2.88	0.383	10.4	1.85	0.214
1.00	65.4	10.41	1.658	25.5	4.14	0.644	20.3	3.26	0.511	15.9	2.59	0.395	10.1	1.82	0.229
1.10	81.7	14.56	2.505	21.4	3.80	0.655	17.1	2.92	0.520	13.6	2.25	0.405	9.1	1.78	0.244
1.20	33.2	6.50	1.210	17.5	3.60	0.636	13.1	2.82	0.476	10.6	2.28	0.378	7.9	1.75	0.243
1.30	41.2	8.54	1.764	15.5	3.84	0.664	11.0	2.98	0.469	8.0	2.33	0.332	7.1	1.78	0.249
1.40	19.6	4.79	0.973	14.7	3.47	0.727	11.9	2.71	0.588	8.8	2.37	0.428	7.0	1.87	0.280
1.50	15.6	4.45	0.890	14.7	3.60	0.836	12.1	3.13	0.687	8.7	2.55	0.478	6.9	1.91	0.307
1.60	29.4	8.07	1.904	16.9	4.90	1.092	11.6	3.52	0.747	8.7	2.45	0.542	6.5	1.93	0.320
1.70	39.9	10.85	2.917	15.3	4.66	1.118	10.3	3.14	0.745	7.7	2.38	0.542	5.9	1.92	0.316
1.80	17.6	5.46	1.444	11.4	3.56	0.937	8.3	3.19	0.674	6.2	2.57	0.493	5.2	1.87	0.299
1.90	16.3	5.11	1.491	10.2	3.86	0.927	7.9	3.29	0.717	5.8	2.59	0.508	4.7	1.79	0.319
2.00	24.4	8.05	2.469	11.2	4.01	1.133	7.5	3.03	0.751	5.6	2.56	0.530	4.5	1.69	0.332
2.20	14.3	5.34	1.752	7.0	3.27	0.856	5.5	2.59	0.665	4.6	2.04	0.519	4.0	1.57	0.327
2.40	5.8	3.44	0.847	4.8	3.02	0.699	4.0	2.68	0.586	3.2	2.20	0.440	3.3	1.52	0.312
2.60	9.8	4.53	1.674	3.9	2.64	0.667	3.4	2.26	0.574	2.8	1.96	0.449	2.7	1.61	0.305
2.80	4.4	2.94	0.873	2.8	2.58	0.560	2.5	2.35	0.485	2.1	2.05	0.395	2.4	1.68	0.293
3.00	3.3	2.19	0.758	2.6	2.16	0.602	2.2	2.09	0.502	1.8	1.96	0.401	2.1	1.70	0.289
3.20	2.5	1.74	0.661	2.0	1.77	0.519	1.9	1.81	0.488	1.7	1.82	0.413	1.9	1.70	0.283
3.40	3.4	1.96	0.981	2.1	1.66	0.621	1.8	1.69	0.507	1.5	1.72	0.408	1.7	1.68	0.290
3.60	1.6	1.66	0.531	1.4	1.60	0.450	1.3	1.62	0.412	1.2	1.67	0.366	1.5	1.67	0.281
3.80	1.2	1.62	0.421	0.9	1.56	0.330	0.9	1.60	0.314	0.9	1.65	0.313	1.4	1.66	0.269
4.00	0.9	1.62	0.377	0.7	1.64	0.286	0.7	1.64	0.278	0.8	1.65	0.279	1.3	1.65	0.255

PER = PERIOD (SEC) AA = ABSOLUTE ACC. (GAL) RV = RELATIVE VELOCITY (CH/SEC) RD = RELATIVE DISPLACEMENT (CH)

M-1183 YAMASHITA-HEN-M

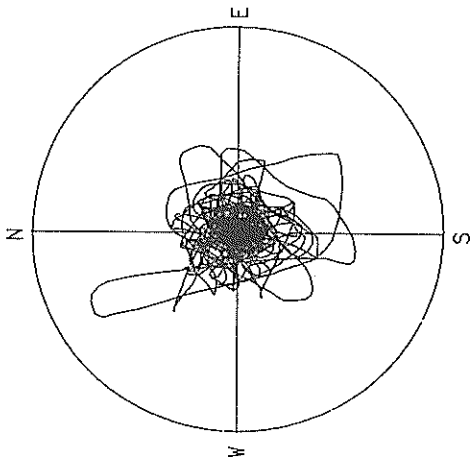

ACCELERATION
R=200.0GAL
MAX=161.1GAL

M-1183 YAMASHITA-HEN-M

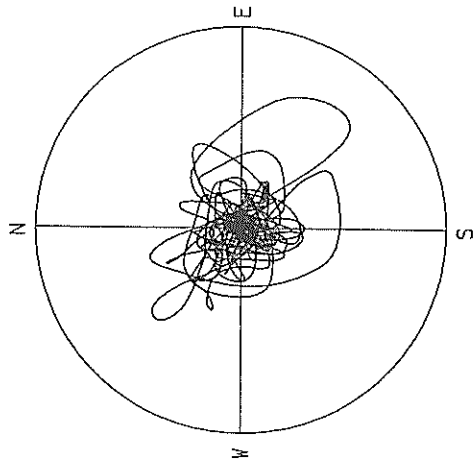

VELOCITY
R=15.0 CM/SEC.
MAX=11.4 CM/SEC.

M-1183 YAMASHITA-HEN-M

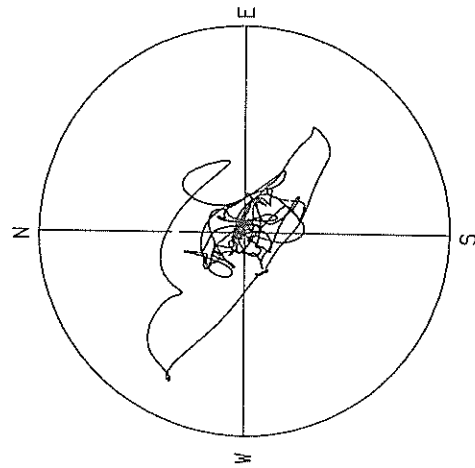

DISPLACEMENT
R=3.00 CM
MAX=2.45 CM

RECORD NUMBER
STATION

F-95

YAMASHITA-F

EARTHQUAKE DATA

DATA AND TIME *****
LOCATION OF HYPOCENTER *****
EPICENTRAL REGION *****
LATITUDE *****
LONGITUDE *****
DEPTH *****
MAGNITUDE *****

11: 8 DEC.17,1987

CHIBA-KEN-TOHO-OKI

35°22' N

140°30' E

58KM

6.7

PEAK VALUES OF COMPONENTS

N S E W U D HORIZONTAL*

PARAMETER OF THE VARIABLE FILTER

FC (HZ) 0.048 0.079 0.097
MAXIMUM ACCELERATION (GAL)
SMAC-B2 EQUIVALENT 55.6 113.3 28.6 113.6
ORIGINAL 61.7 130.7 34.7 132.0
CORRECTED 61.5 131.1 34.3 132.3
MAXIMUM VELOCITY (CM/SEC)
FIXED FILTER 6.60 9.31 2.66 11.15
VARIABLE FILTER 6.87 8.18 2.41 9.86
MAXIMUM DISPLACEMENT (CM)
FIXED FILTER 2.211 2.353 0.843 2.892
VARIABLE FILTER 3.699 3.311 0.896 4.943

* RESULTANT OF HORIZONTAL COMPONENTS

F-95 YAMASHITA-F

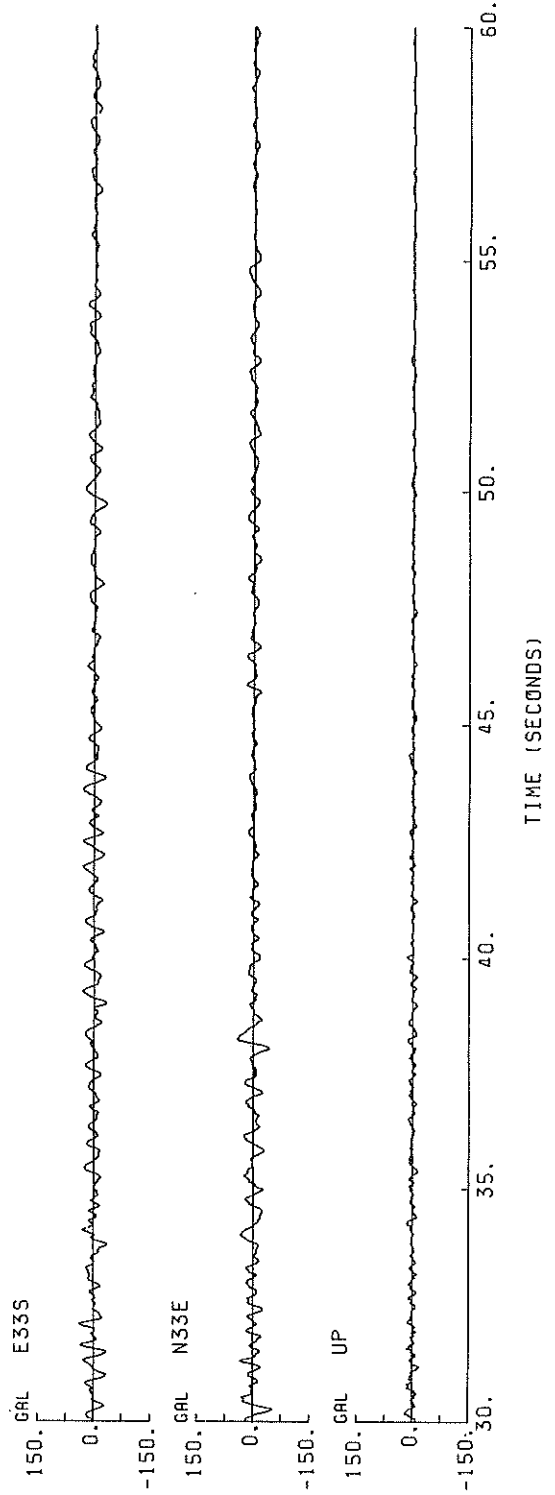
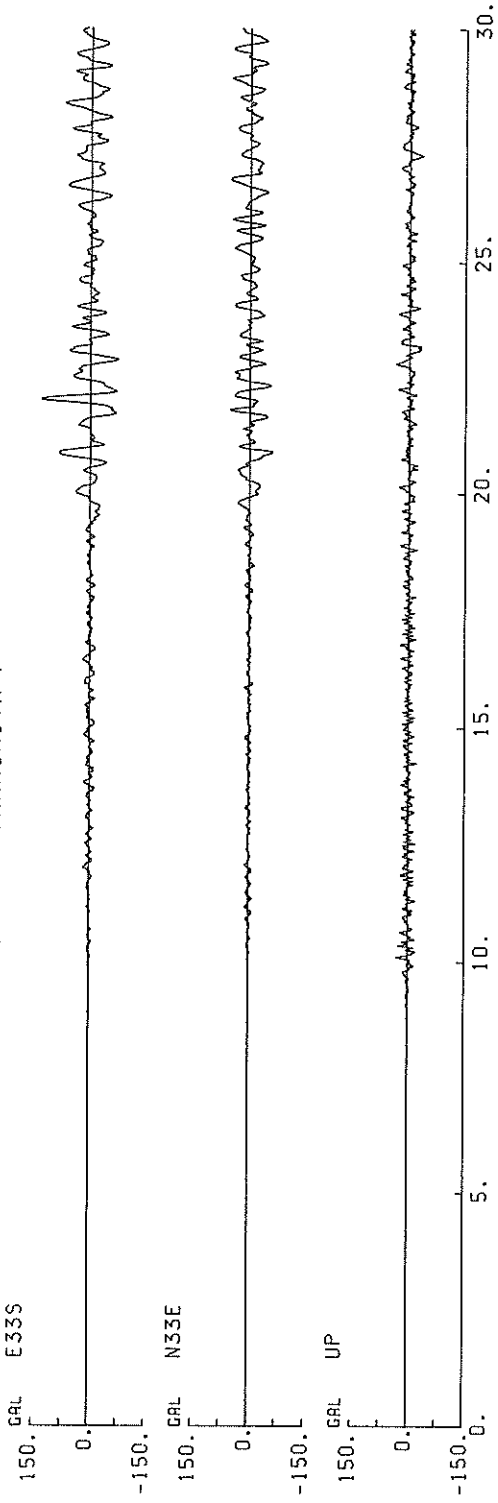

F-95 N33E YAMASHITA-F

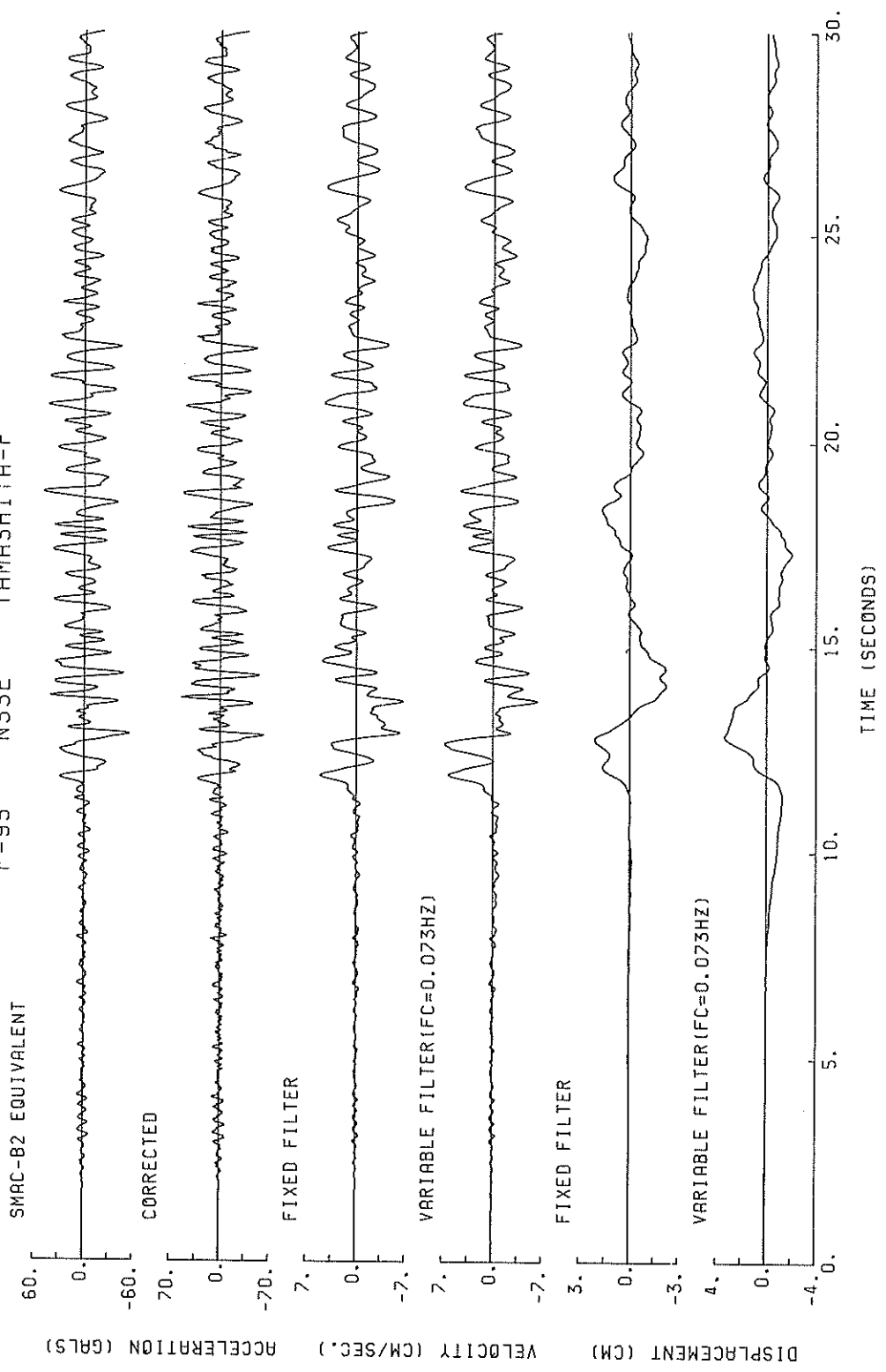

F-95 N33E YAMASHITA-F

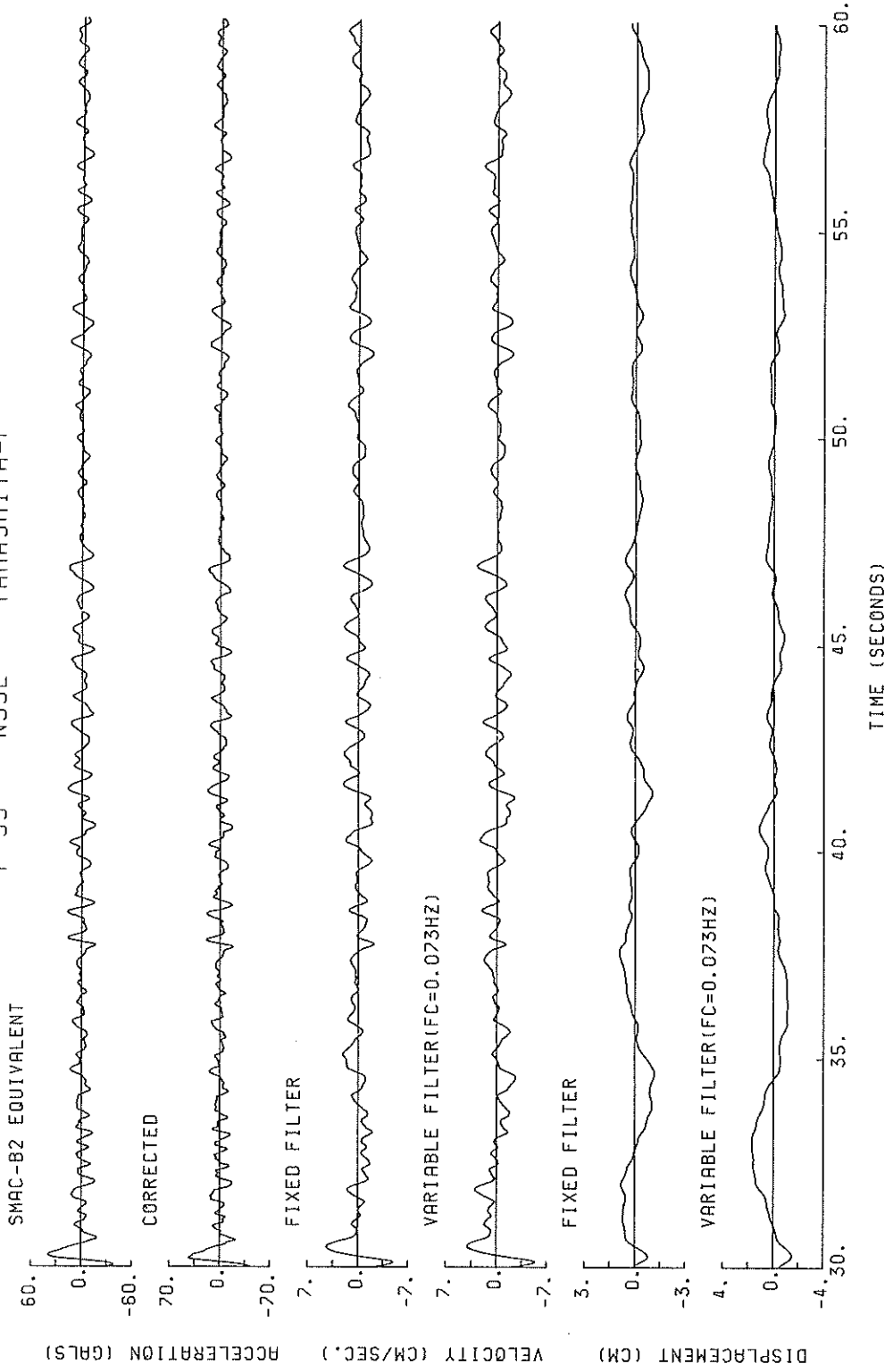

F-95 E33S YAMASHITA-F

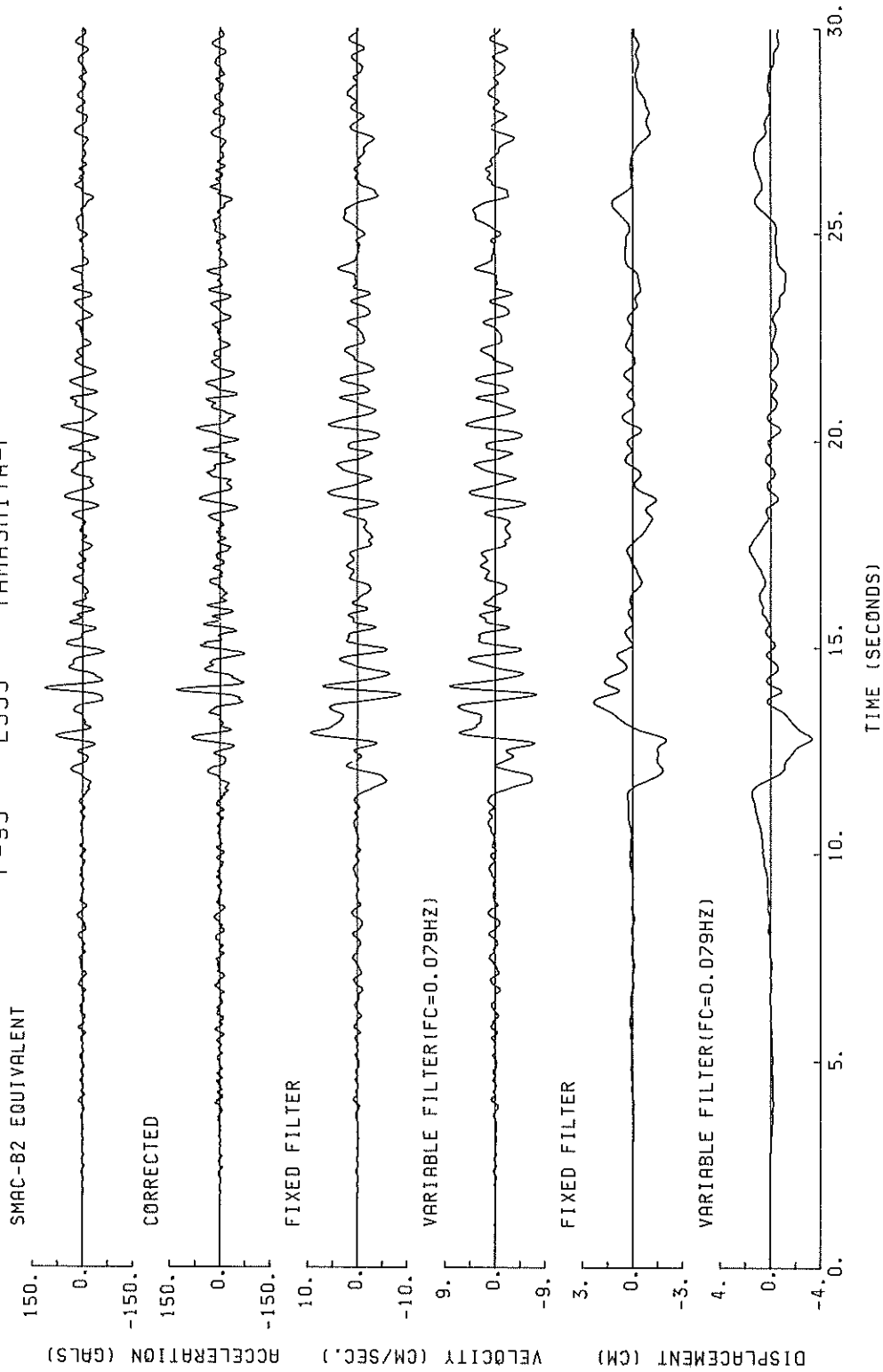

F-95 E33S YAMASHITA-F

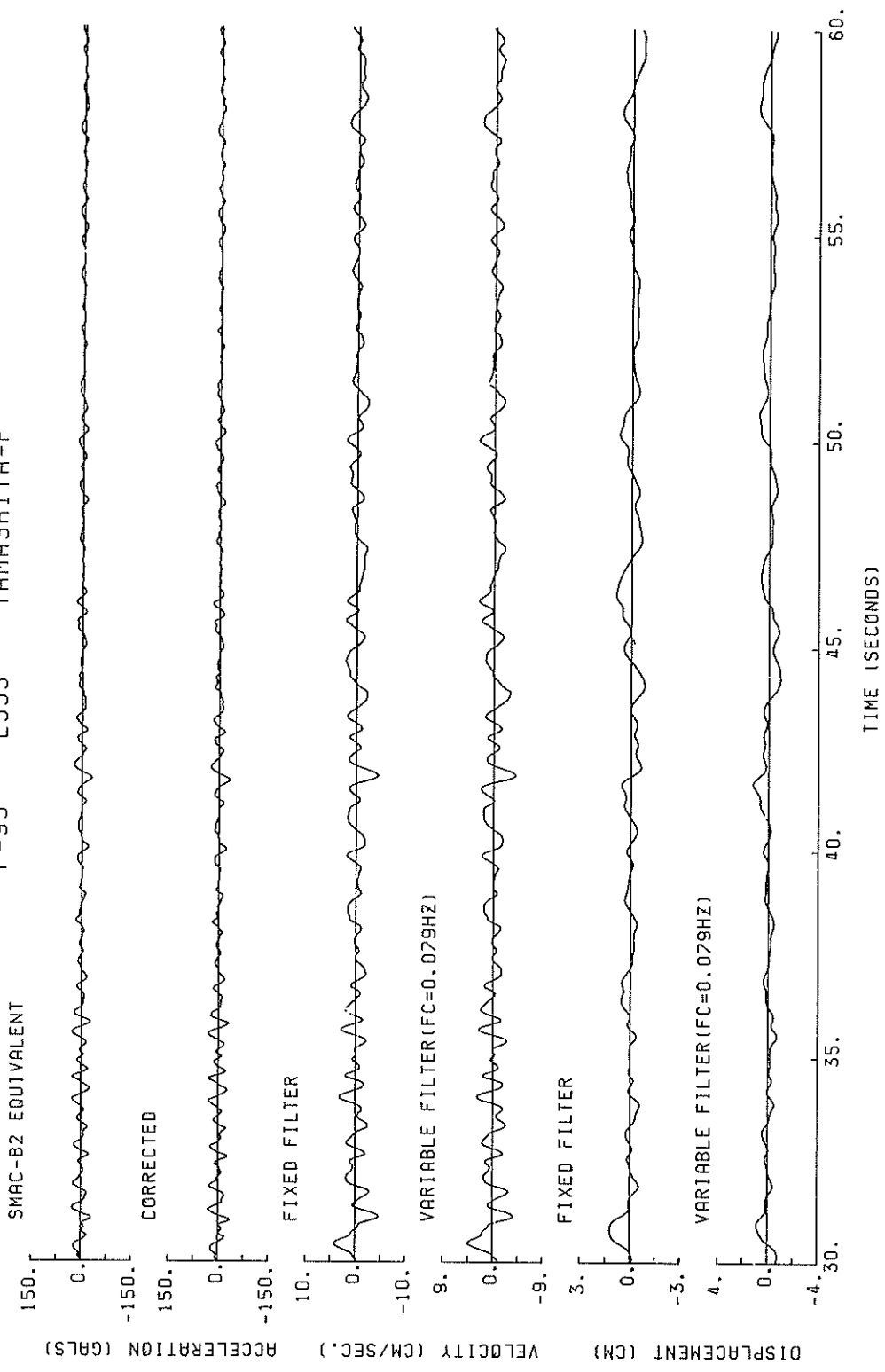

F-95 UP YAMASHITA-F

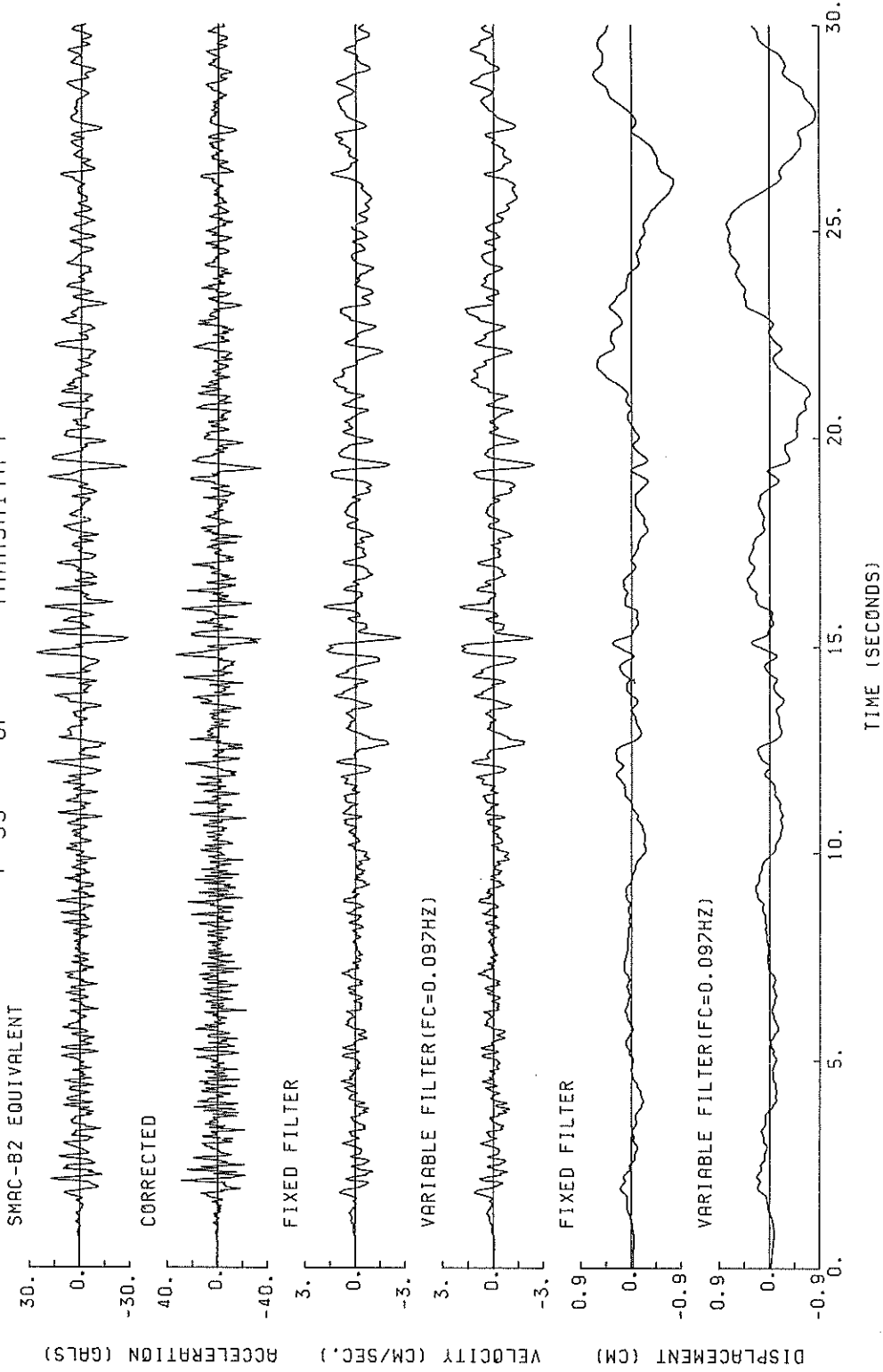

F-95 UP YAMASHITA-F

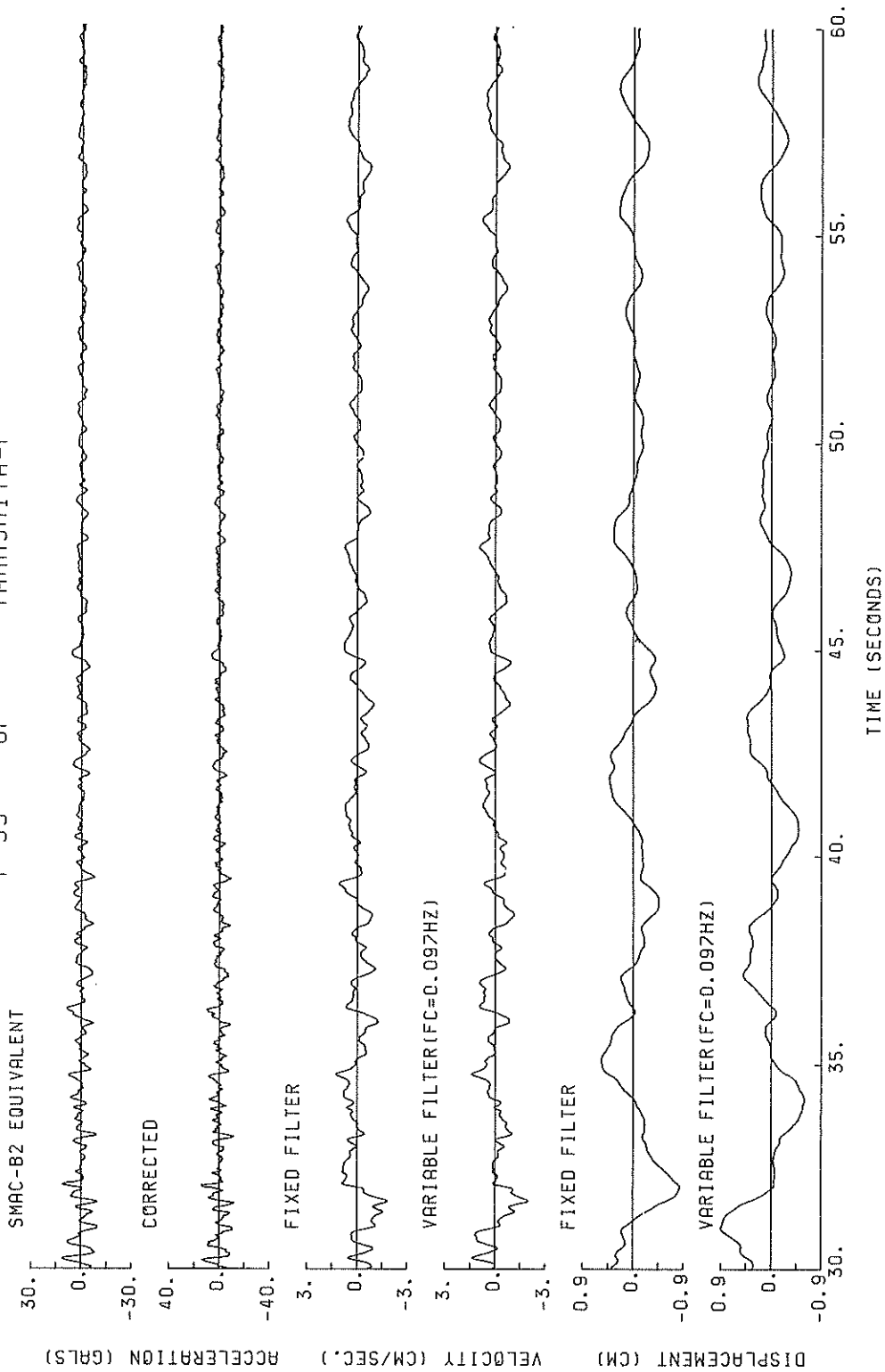

F-95 N33E YAMASHITA-F
(1/FC=20.63SEC.)

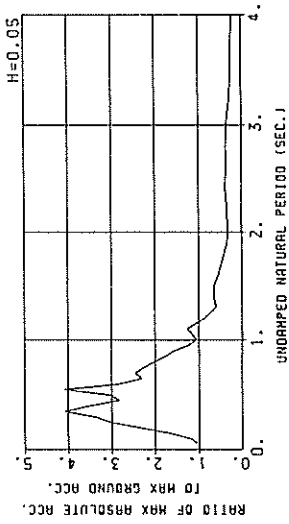

F-95 E33S YAMASHITA-F
(1/FC=12.66SEC.)

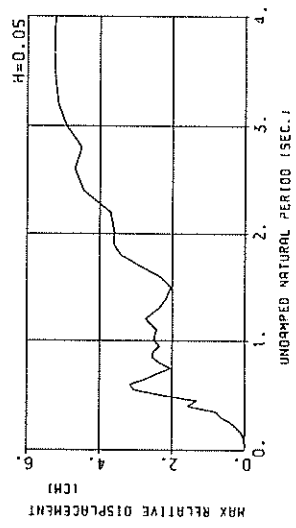
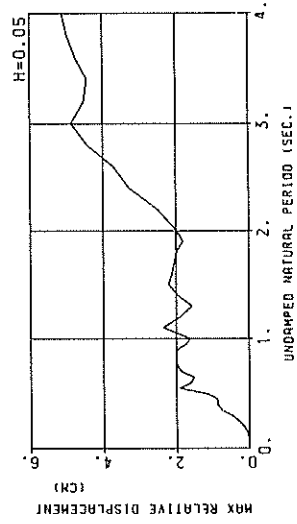
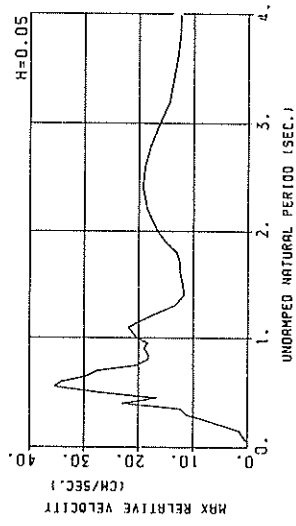
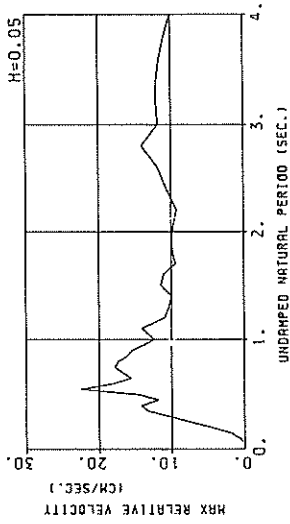
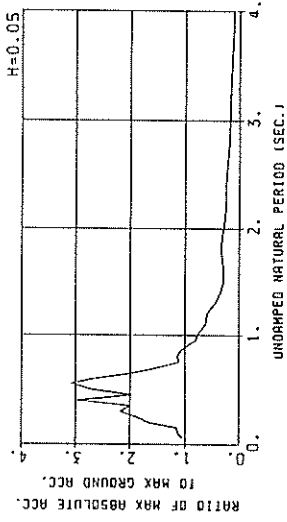

RESPONSE SPECTRA

RESPONSE SPECTRA

F-95 UP YAMASHITA-F
(1/FC=10.28SEC.)

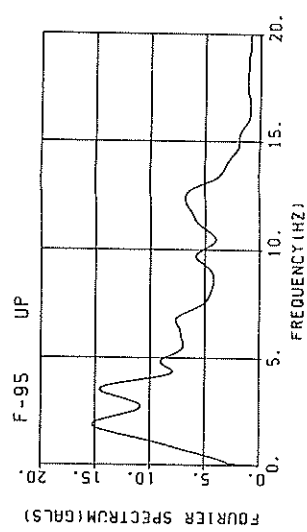
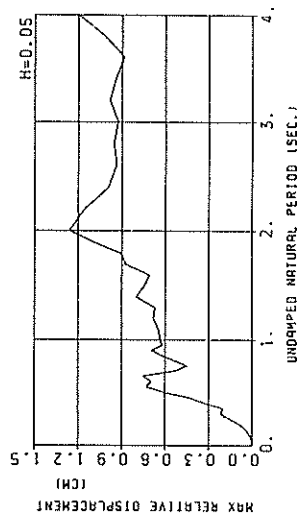
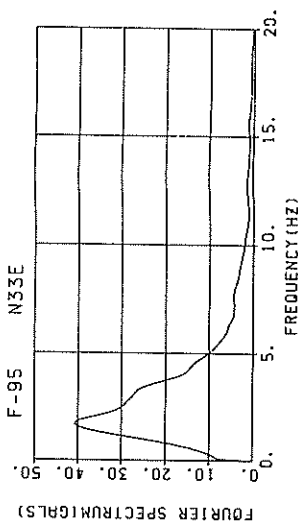
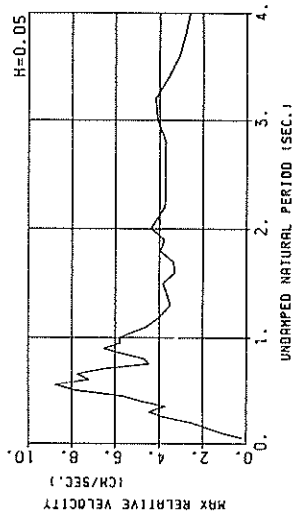
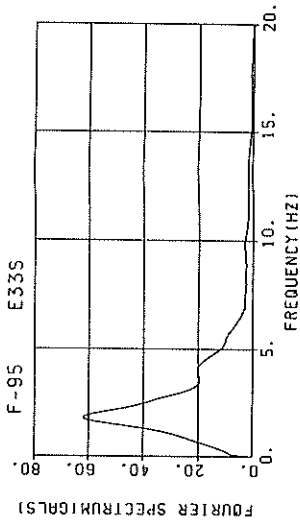
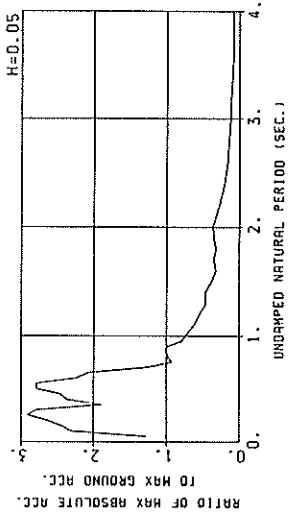

RESPONSE SPECTRA

FOURIER SPECTRA

RESPONSE SPECTRUM

RECORD = F-95
 DATE AND TIME = 1987-12-17-11-8
 TIME LENGTH = 59.99 (SEC)

COMPONENT = E33S
 SIGNAL = GR. ACC.
 SAMPRING INTERVAL = 0.0100(SEC)
 SKIPPED LENGTH = 0.00 (SEC)

STATION = YAMASHITA-F
 MAX-GROUND ACC. = 131.07 (GAL)

PERIOD (SEC) PERIOD (SEC) PERIOD (SEC) PERIOD (SEC) PERIOD (SEC) PERIOD (SEC) PERIOD (SEC) PERIOD (SEC) PERIOD (SEC) PERIOD (SEC)

PER AA RV RD AA RV RD AA RV RD AA RV RD AA RV RD AA RV RD AA RV RD AA RV RD

DAMPING = 0. DAMPING = 0.025 DAMPING = 0.050 DAMPING = 0.100 DAMPING = 0.250

0.05	159.9	0.47	0.010	136.8	0.16	0.009	135.0	0.16	0.009	134.0	0.15	0.008	133.6	0.14	0.008	133.6	0.14	0.008	133.6	0.14	0.008
0.10	360.2	4.98	0.091	145.6	1.05	0.037	146.9	0.85	0.037	147.2	0.64	0.037	145.9	0.57	0.036	145.9	0.57	0.036	145.9	0.57	0.036
0.15	285.8	6.70	0.163	138.4	1.78	0.079	150.4	1.60	0.086	161.0	1.35	0.091	161.8	1.29	0.090	161.8	1.29	0.090	161.8	1.29	0.090
0.20	474.2	14.75	0.480	220.4	4.87	0.223	217.1	4.85	0.219	207.1	4.14	0.207	178.9	3.04	0.174	180.3	3.02	0.174	180.3	3.02	0.174
0.25	827.5	32.29	1.310	304.5	12.13	0.483	246.1	7.85	0.389	214.8	6.89	0.355	180.3	5.02	0.270	180.3	5.02	0.270	180.3	5.02	0.270
0.30	483.8	21.15	1.103	341.8	13.85	0.777	285.2	11.23	0.648	233.6	9.21	0.524	178.7	6.82	0.382	178.7	6.82	0.382	178.7	6.82	0.382
0.35	454.6	24.44	1.411	295.9	14.51	0.918	260.4	12.34	0.807	242.0	11.41	0.740	185.4	8.74	0.535	185.4	8.74	0.535	185.4	8.74	0.535
0.40	854.6	54.27	3.464	491.4	29.04	1.991	389.2	23.01	1.573	287.6	17.06	1.148	191.8	10.67	0.709	191.8	10.67	0.709	191.8	10.67	0.709
0.45	310.4	22.03	1.592	253.7	17.19	1.302	258.5	14.75	1.321	247.7	16.45	1.251	189.2	11.97	0.873	189.2	11.97	0.873	189.2	11.97	0.873
0.50	780.5	60.13	4.942	446.3	33.55	2.822	355.0	27.06	2.338	270.7	20.85	1.686	186.1	12.94	1.042	186.1	12.94	1.042	186.1	12.94	1.042
0.55	988.0	87.20	7.570	554.0	49.30	4.244	402.6	35.43	3.070	269.1	23.53	2.021	177.4	13.39	1.180	177.4	13.39	1.180	177.4	13.39	1.180
0.60	675.7	64.53	6.162	439.0	43.78	3.994	349.4	34.17	3.168	238.5	22.92	2.125	160.4	14.46	1.244	160.4	14.46	1.244	160.4	14.46	1.244
0.65	663.8	70.84	7.104	323.2	36.97	3.455	256.8	29.52	2.733	197.2	23.29	2.053	138.2	14.99	1.236	138.2	14.99	1.236	138.2	14.99	1.236
0.70	297.5	38.96	3.693	233.8	32.20	2.897	194.1	27.51	2.391	146.0	21.77	1.761	115.4	14.76	1.170	115.4	14.76	1.170	115.4	14.76	1.170
0.75	318.3	38.12	4.535	174.1	24.87	2.675	143.9	20.29	2.039	121.3	17.25	1.687	95.8	14.11	1.137	95.8	14.11	1.137	95.8	14.11	1.137
0.80	267.1	34.26	4.331	165.2	21.97	2.673	147.4	18.32	2.375	121.8	14.01	1.924	88.2	13.42	1.224	88.2	13.42	1.224	88.2	13.42	1.224
0.85	332.3	44.66	6.081	159.7	21.53	2.919	140.3	18.31	2.354	114.1	15.09	2.036	82.4	13.08	1.272	82.4	13.08	1.272	82.4	13.08	1.272
0.90	404.9	58.46	8.308	140.1	21.27	2.869	123.5	19.05	2.520	101.1	15.76	2.024	75.2	13.13	1.285	75.2	13.13	1.285	75.2	13.13	1.285
0.95	386.1	58.45	8.827	123.7	22.29	2.822	103.3	18.39	2.348	86.2	15.54	1.926	67.5	13.42	1.267	67.5	13.42	1.267	67.5	13.42	1.267
1.00	205.0	34.62	5.194	117.8	22.93	2.979	99.8	20.45	2.508	76.2	17.36	1.862	59.8	13.74	1.232	59.8	13.74	1.232	59.8	13.74	1.232
1.10	193.7	33.09	5.936	90.2	24.32	2.760	79.8	21.90	2.427	66.4	18.61	1.968	55.4	14.05	1.399	55.4	14.05	1.399	55.4	14.05	1.399
1.20	333.9	63.25	12.178	98.9	19.76	3.528	75.8	17.92	2.752	64.6	16.54	2.252	54.0	13.66	1.587	54.0	13.66	1.587	54.0	13.66	1.587
1.30	147.3	30.18	6.308	67.1	14.00	2.869	55.9	13.30	2.356	53.6	13.84	2.160	50.7	12.94	1.699	50.7	12.94	1.699	50.7	12.94	1.699
1.40	77.5	18.56	3.846	53.1	13.74	2.631	43.7	11.66	2.153	44.2	12.38	2.045	47.1	12.21	1.777	47.1	12.21	1.777	47.1	12.21	1.777
1.50	45.7	11.83	2.602	34.8	11.80	1.975	36.6	11.86	2.042	39.5	11.94	2.091	43.9	11.55	1.855	43.9	11.55	1.855	43.9	11.55	1.855
1.60	93.7	23.45	6.073	41.5	12.69	2.687	36.8	12.35	2.337	38.4	11.79	2.307	41.4	10.91	1.940	41.4	10.91	1.940	41.4	10.91	1.940
1.70	83.8	22.59	6.132	42.2	13.49	3.074	40.5	12.46	2.907	38.8	11.32	2.631	39.2	10.56	2.023	39.2	10.56	2.023	39.2	10.56	2.023
1.80	76.0	23.58	6.234	48.5	15.36	3.803	42.6	13.07	3.430	38.6	12.58	2.920	37.1	11.20	2.079	37.1	11.20	2.079	37.1	11.20	2.079
1.90	73.1	37.81	11.260	50.7	19.36	4.626	40.4	15.20	3.618	36.9	14.00	3.061	34.9	11.85	2.097	34.9	11.85	2.097	34.9	11.85	2.097
2.00	126.9	36.02	7.795	44.9	17.82	4.539	36.3	16.59	3.577	35.3	15.19	3.058	32.4	12.46	2.062	32.4	12.46	2.062	32.4	12.46	2.062
2.20	65.2	24.02	7.994	35.5	19.54	4.346	30.6	18.54	3.717	25.7	16.85	3.029	27.2	13.43	2.082	27.2	13.43	2.082	27.2	13.43	2.082
2.40	39.7	21.44	5.785	34.2	20.31	4.982	30.9	19.29	4.461	26.1	17.55	3.622	21.9	13.98	2.290	21.9	13.98	2.290	21.9	13.98	2.290
2.60	34.3	20.80	5.875	30.7	19.83	5.240	27.7	18.93	4.694	23.6	17.39	3.814	18.6	14.10	2.458	18.6	14.10	2.458	18.6	14.10	2.458
2.80	53.8	24.36	10.677	28.0	18.30	5.144	23.0	17.82	4.510	20.2	16.60	3.928	16.6	13.91	2.811	16.6	13.91	2.811	16.6	13.91	2.811
3.00	38.9	21.62	8.866	25.3	16.52	5.757	22.0	16.16	4.359	19.8	15.42	4.339	15.6	13.68	3.121	15.6	13.68	3.121	15.6	13.68	3.121
3.20	32.4	17.40	8.400	21.3	15.16	5.498	20.3	14.36	4.165	18.7	14.09	4.359	15.6	12.90	3.355	15.6	12.90	3.355	15.6	12.90	3.355
3.40	22.0	15.05	6.444	18.9	14.36	5.511	18.3	13.67	5.235	17.2	12.82	4.719	14.9	12.47	3.522	14.9	12.47	3.522	14.9	12.47	3.522
3.60	21.9	13.98	7.188	16.9	13.46	5.509	16.4	12.94	5.359	15.8	12.26	4.781	14.2	11.62	3.630	14.2	11.62	3.630	14.2	11.62	3.630
3.80	17.9	13.00	6.551	15.2	12.65	5.527	14.8	12.48	5.268	14.4	12.13	4.795	13.4	11.09	3.687	13.4	11.09	3.687	13.4	11.09	3.687
4.00	24.7	15.31	10.020	13.7	12.54	5.500	13.3	12.34	5.329	13.0	11.99	4.756	12.7	11.04	3.702	12.7	11.04	3.702	12.7	11.04	3.702

PER = PERIOD (SEC) AA = ABSOLUTE ACC. (GAL) RV = RELATIVE VELOCITY (CM/SEC) RD = RELATIVE DISPLACEMENT (CM)

RESPONSE SPECTRUM

RECORD = F-95
 DATE AND TIME = 1987-12-17-11-8
 TIME LENGTH = 59.99 (SEC)
 COMPONENT = N33E
 SIGNAL = GR. ACC.
 SAMPLING INTERVAL = 0.0100(SEC)
 SKIPPED LENGTH = 0.00 (SEC)
 CORRECTION =
 MAX-GROUND ACC. = 61.34 (GAL)
 STATION = YAMASHITA-F

PER	DAMPING = 0.				DAMPING = 0.025				DAMPING = 0.050				DAMPING = 0.100				DAMPING = 0.250			
	AA	RV	RD	AA	RV	RD	AA	RV	RD	AA	RV	RD	AA	RV	RD	AA	RV	RD		
0.05	95.5	0.44	0.006	64.0	0.12	0.004	63.4	0.11	0.004	62.7	0.09	0.004	62.2	0.09	0.004	62.2	0.09	0.004		
0.10	188.8	2.38	0.048	76.8	0.79	0.019	72.9	0.58	0.018	69.9	0.46	0.018	68.9	0.40	0.017	68.9	0.40	0.017		
0.15	214.5	4.83	0.122	127.4	2.25	0.072	103.0	1.84	0.059	84.6	1.47	0.048	83.2	1.01	0.040	83.2	1.01	0.040		
0.20	352.0	10.17	0.357	154.3	5.07	0.166	143.0	4.28	0.144	118.3	3.27	0.118	89.6	1.98	0.085	89.6	1.98	0.085		
0.25	356.0	12.42	0.532	225.4	8.88	0.355	186.3	7.27	0.293	141.4	5.19	0.219	92.9	2.82	0.153	92.9	2.82	0.153		
0.30	517.9	23.83	1.181	283.8	13.33	0.648	207.1	10.09	0.472	150.3	6.74	0.338	98.6	3.57	0.209	98.6	3.57	0.209		
0.35	914.5	50.76	2.838	312.5	16.27	0.968	250.4	13.21	0.771	176.3	9.45	0.538	102.8	4.79	0.289	102.8	4.79	0.289		
0.40	672.2	42.83	2.724	294.0	19.18	1.193	217.8	14.16	0.878	151.1	9.07	0.603	89.3	5.01	0.350	89.3	5.01	0.350		
0.45	351.9	23.62	1.805	220.1	14.85	1.129	173.8	11.81	0.889	131.2	9.09	0.662	90.6	5.38	0.427	90.6	5.38	0.427		
0.50	270.1	20.94	1.710	237.1	13.77	1.500	187.2	14.45	1.180	142.0	10.99	0.882	88.2	5.69	0.501	88.2	5.69	0.501		
0.55	750.0	64.92	5.747	362.4	32.44	2.774	251.3	22.51	1.915	150.3	13.34	1.127	81.6	6.43	0.552	81.6	6.43	0.552		
0.60	616.9	58.63	5.626	244.4	24.84	2.229	176.2	18.27	1.598	125.1	12.86	1.115	83.1	6.91	0.687	83.1	6.91	0.687		
0.65	251.0	26.27	2.686	164.3	17.33	1.754	141.7	15.56	1.509	120.3	11.52	1.261	85.4	6.88	0.811	85.4	6.88	0.811		
0.70	535.8	60.35	6.626	207.7	23.75	2.575	150.6	16.69	1.858	121.6	11.26	1.474	83.8	6.73	0.905	83.8	6.73	0.905		
0.75	555.4	66.94	7.913	195.5	24.50	2.781	138.9	17.77	1.977	114.4	11.97	1.589	79.1	7.54	0.962	79.1	7.54	0.962		
0.80	483.6	51.49	6.543	180.4	22.65	2.596	124.5	17.33	2.006	102.3	13.04	1.618	72.2	8.27	0.985	72.2	8.27	0.985		
0.85	187.1	26.06	3.424	126.8	19.17	2.318	108.5	16.11	1.977	88.4	13.40	1.584	64.4	8.71	0.979	64.4	8.71	0.979		
0.90	330.4	47.00	6.779	137.6	19.42	2.819	96.3	15.37	1.967	74.9	13.08	1.511	56.4	8.86	0.952	56.4	8.86	0.952		
0.95	138.6	20.17	3.167	89.5	14.65	2.042	76.0	13.85	1.728	63.4	12.28	1.426	48.8	8.33	0.917	48.8	8.33	0.917		
1.00	146.1	22.24	3.702	85.4	14.64	2.159	64.3	12.42	1.620	56.9	11.34	1.406	43.4	8.82	0.958	43.4	8.82	0.958		
1.10	248.3	43.75	7.612	104.7	19.30	3.205	77.0	14.05	2.347	54.0	9.67	1.614	38.6	8.00	1.014	38.6	8.00	1.014		
1.20	85.5	18.56	3.120	80.2	11.91	2.192	52.2	10.88	1.891	41.0	8.77	1.448	33.5	7.27	1.031	33.5	7.27	1.031		
1.30	49.1	10.92	2.101	38.6	10.68	1.650	37.0	10.29	1.573	31.2	8.76	1.316	29.2	7.17	1.039	29.2	7.17	1.039		
1.40	102.5	23.52	5.089	49.4	11.35	2.448	39.9	9.96	1.964	32.4	8.65	1.553	25.7	7.08	1.040	25.7	7.08	1.040		
1.50	79.9	19.63	4.554	46.4	13.39	2.641	39.0	11.46	2.208	29.5	9.15	1.629	23.5	6.83	1.052	23.5	6.83	1.052		
1.60	90.5	23.42	5.869	40.4	13.31	2.615	32.8	11.02	2.104	26.9	8.84	1.663	22.4	6.82	1.117	22.4	6.82	1.117		
1.70	52.3	17.16	3.828	31.2	11.67	2.277	28.6	9.41	2.061	24.6	7.67	1.701	20.9	6.10	1.144	20.9	6.10	1.144		
1.80	50.4	14.15	4.134	31.2	10.77	2.552	24.6	9.75	1.986	20.9	8.24	1.604	19.1	6.14	1.138	19.1	6.14	1.138		
1.90	58.7	19.16	3.365	28.2	11.94	2.571	20.0	9.93	1.806	17.3	8.24	1.545	17.4	6.29	1.212	17.4	6.29	1.212		
2.00	50.4	12.35	3.082	21.3	10.36	2.156	19.5	9.81	1.965	17.7	8.33	1.741	15.8	6.52	1.316	15.8	6.52	1.316		
2.20	45.7	16.64	5.606	25.5	10.26	3.116	20.8	9.24	2.524	18.0	8.26	2.117	14.6	6.96	1.504	14.6	6.96	1.504		
2.40	30.3	13.56	4.422	25.4	11.84	3.687	22.9	10.65	3.300	19.4	9.40	2.688	14.8	7.30	1.664	14.8	7.30	1.664		
2.60	49.7	21.09	8.512	27.2	13.75	4.643	21.9	11.84	3.720	18.4	9.81	3.017	14.5	7.54	2.013	14.5	7.54	2.013		
2.80	62.6	28.14	12.429	30.0	16.46	5.952	22.7	14.06	4.456	17.7	10.95	3.384	14.7	7.68	2.312	14.7	7.68	2.312		
3.00	39.5	20.10	8.959	28.1	14.41	6.394	21.6	11.79	4.875	16.3	10.17	3.474	14.6	7.74	2.555	14.6	7.74	2.555		
3.20	28.7	18.99	7.459	21.1	14.63	5.451	17.5	11.99	4.490	15.3	10.61	3.684	14.2	7.82	2.742	14.2	7.82	2.742		
3.40	32.0	17.16	9.380	16.8	12.60	4.900	15.1	11.90	4.400	14.3	10.65	3.908	13.7	8.03	2.878	13.7	8.03	2.878		
3.60	18.0	12.80	5.910	15.8	10.40	4.713	14.5	11.48	4.713	13.1	10.40	4.188	13.0	8.05	3.052	13.0	8.05	3.052		
3.80	20.2	12.28	7.391	14.5	11.30	5.299	13.7	10.80	4.931	12.5	9.93	4.394	12.3	7.93	3.229	12.3	7.93	3.229		
4.00	14.1	11.31	5.712	13.3	10.32	5.345	12.7	9.96	5.048	11.8	9.32	4.526	11.6	7.72	3.364	11.6	7.72	3.364		

PER = PERIOD (SEC) AA = ABSOLUTE ACC. (GAL) RV = RELATIVE VELOCITY (CM/SEC) RD = RELATIVE DISPLACEMENT (CM)

RESPONSE SPECTRUM

RECORD = F-95
 DATE AND TIME = 1987-12-17-11-8
 TIME LENGTH = 59.99 (SEC)
 COMPONENT = UP
 SIGNAL = GR. ACC.
 SAMPRING INTERVAL = 0.0100(SEC)
 SKIPPED LENGTH = 0.00 (SEC)
 CORRECTION =
 MAX.GROUND ACC. = 34.29 (GAL)
 STATION = YAMASHITA-F

PER	DAMPING = 0.				DAMPING = 0.025				DAMPING = 0.050				DAMPING = 0.100				DAMPING = 0.250			
	AA	RV	RD	AA	AA	RV	RD	AA	AA	RV	RD	AA	AA	RV	RD	AA	AA	RV	RD	
0.05	163.9	1.12	0.010	46.5	0.22	0.003	43.1	0.16	0.003	39.7	0.13	0.003	36.9	0.12	0.003	36.9	0.12	0.002	0.002	
0.10	680.1	10.77	0.172	110.5	1.65	0.028	79.0	1.13	0.020	54.9	0.75	0.014	42.9	0.48	0.011	42.9	0.48	0.011	0.011	
0.15	733.0	17.19	0.418	128.9	2.90	0.073	84.2	1.92	0.048	56.3	1.15	0.032	44.6	0.71	0.024	44.6	0.71	0.024	0.024	
0.20	350.6	11.05	0.355	110.4	3.35	0.112	90.4	2.59	0.091	67.6	1.77	0.068	45.9	1.08	0.044	45.9	1.08	0.044	0.044	
0.25	438.5	17.19	0.694	117.4	4.52	0.186	99.9	3.81	0.157	76.5	2.75	0.119	49.1	1.62	0.072	49.1	1.62	0.072	0.072	
0.30	248.1	11.88	0.566	112.6	5.38	0.257	95.4	4.77	0.216	73.9	3.50	0.165	45.5	1.92	0.094	45.5	1.92	0.094	0.094	
0.35	525.1	18.06	1.009	91.5	5.09	0.285	64.8	3.68	0.201	56.2	2.85	0.172	43.8	2.09	0.122	43.8	2.09	0.122	0.122	
0.40	270.8	17.13	1.098	109.1	6.79	0.442	81.1	4.81	0.327	65.6	3.58	0.262	44.0	2.61	0.162	44.0	2.61	0.162	0.162	
0.45	192.9	13.63	0.987	99.4	6.94	0.510	84.4	5.68	0.430	66.4	4.37	0.335	45.0	3.15	0.214	45.0	3.15	0.214	0.214	
0.50	225.7	17.89	1.430	117.9	9.22	0.744	95.4	7.81	0.602	69.3	6.02	0.432	48.7	3.60	0.278	48.7	3.60	0.278	0.278	
0.55	179.9	16.90	1.379	116.3	10.56	0.890	95.7	8.76	0.729	74.3	6.63	0.555	49.0	3.74	0.328	49.0	3.74	0.328	0.328	
0.60	204.8	13.67	1.868	87.2	8.66	0.794	76.7	7.22	0.695	64.9	5.83	0.576	45.6	3.56	0.356	45.6	3.56	0.356	0.356	
0.65	168.6	17.44	1.805	88.2	9.43	0.943	70.9	7.78	0.755	54.5	5.96	0.568	40.5	3.67	0.358	40.5	3.67	0.358	0.358	
0.70	119.7	13.88	1.486	54.8	7.73	0.678	42.8	6.53	0.527	39.0	5.47	0.469	34.7	3.84	0.350	34.7	3.84	0.350	0.350	
0.75	67.4	7.89	0.961	42.4	5.31	0.603	31.7	4.47	0.449	30.0	4.56	0.413	29.9	3.88	0.340	29.9	3.88	0.340	0.340	
0.80	132.9	16.79	2.155	49.6	6.52	0.802	33.4	4.72	0.536	28.1	4.49	0.441	26.0	3.90	0.331	26.0	3.90	0.331	0.331	
0.85	87.1	12.32	1.595	43.8	7.40	0.799	34.2	5.64	0.621	26.9	4.97	0.476	22.7	3.93	0.320	22.7	3.93	0.320	0.320	
0.90	82.8	11.91	1.598	46.7	7.87	0.957	34.0	6.55	0.692	23.2	5.27	0.460	19.6	3.90	0.303	19.6	3.90	0.303	0.303	
0.95	68.1	10.04	1.557	32.7	6.15	0.745	27.3	5.80	0.619	21.1	4.98	0.465	16.8	3.82	0.291	16.8	3.82	0.291	0.291	
1.00	118.6	18.81	3.004	34.9	7.67	0.884	25.2	5.81	0.634	18.9	4.41	0.465	14.4	3.71	0.285	14.4	3.71	0.285	0.285	
1.10	58.6	10.50	1.796	28.3	5.77	0.865	21.2	4.59	0.646	16.8	3.56	0.489	12.2	3.44	0.277	12.2	3.44	0.277	0.277	
1.20	35.6	6.97	1.398	24.9	4.99	0.907	18.8	3.95	0.680	12.8	3.16	0.454	10.8	3.25	0.301	10.8	3.25	0.301	0.301	
1.30	35.0	7.26	1.496	17.6	4.35	0.752	15.7	3.50	0.669	12.3	3.22	0.514	9.9	3.17	0.336	9.9	3.17	0.336	0.336	
1.40	50.1	11.37	2.485	23.0	5.17	1.139	19.1	3.44	0.796	11.8	3.42	0.573	8.9	3.11	0.361	8.9	3.11	0.361	0.361	
1.50	20.6	6.65	1.175	14.9	4.40	0.845	13.0	3.82	0.740	10.4	3.36	0.585	8.4	3.05	0.377	8.4	3.05	0.377	0.377	
1.60	28.8	7.48	1.868	16.1	4.17	1.041	11.0	3.27	0.707	9.2	2.96	0.566	7.8	2.92	0.383	7.8	2.92	0.383	0.383	
1.70	26.0	7.05	1.901	16.4	4.55	1.199	12.0	3.56	0.875	8.5	2.62	0.591	7.1	2.81	0.404	7.1	2.81	0.404	0.404	
1.80	32.9	9.51	2.702	15.9	5.08	1.301	11.1	3.95	0.905	8.2	2.92	0.660	6.3	2.72	0.427	6.3	2.72	0.427	0.427	
1.90	22.7	7.04	2.074	16.4	4.98	1.499	12.1	3.75	1.098	8.5	2.98	0.762	5.6	2.65	0.448	5.6	2.65	0.448	0.448	
2.00	26.5	8.58	2.685	17.0	5.71	1.725	12.5	4.40	1.260	7.9	3.02	0.787	5.4	2.61	0.464	5.4	2.61	0.464	0.464	
2.20	13.4	4.81	1.645	11.6	4.25	1.420	9.5	3.76	1.154	6.7	2.92	0.808	5.1	2.59	0.503	5.1	2.59	0.503	0.503	
2.40	17.9	6.77	2.610	8.6	4.50	1.250	6.9	3.71	0.992	5.2	3.05	0.758	4.7	2.68	0.534	4.7	2.68	0.534	0.534	
2.60	25.6	10.48	4.391	11.0	4.48	1.885	7.4	3.74	1.264	4.3	3.21	0.795	4.3	2.83	0.564	4.3	2.83	0.564	0.564	
2.80	11.9	5.50	2.372	6.5	3.85	1.285	5.2	3.71	1.026	4.0	3.43	0.775	4.0	2.96	0.594	4.0	2.96	0.594	0.594	
3.00	6.7	4.73	1.521	4.7	4.38	1.043	4.1	4.09	0.926	3.6	3.67	0.793	3.7	3.05	0.616	3.7	3.05	0.616	0.616	
3.20	9.1	5.50	2.356	5.1	4.56	1.326	3.9	4.16	0.999	3.1	3.66	0.777	3.4	3.06	0.629	3.4	3.06	0.629	0.629	
3.40	10.6	5.77	3.095	5.5	3.67	1.603	4.0	3.56	1.168	2.9	3.38	0.823	3.1	3.02	0.662	3.1	3.02	0.662	0.662	
3.60	6.1	3.70	1.999	3.5	3.28	1.160	2.9	3.08	0.945	2.5	3.01	0.754	2.9	2.94	0.664	2.9	2.94	0.664	0.664	
3.80	4.1	2.85	1.485	3.2	2.84	1.185	2.8	2.80	1.019	2.2	2.75	0.807	2.8	2.85	0.701	2.8	2.85	0.701	0.701	
4.00	3.7	2.73	1.505	3.4	2.51	1.359	3.0	2.56	1.196	2.3	2.60	0.919	2.7	2.77	0.755	2.7	2.77	0.755	0.755	

PER = PERIOD (SEC) AA = ABSOLUTE ACC. (GAL) RV = RELATIVE VELOCITY (CM/SEC) RD = RELATIVE DISPLACEMENT (CM)

F-95 YAMASHITA-F

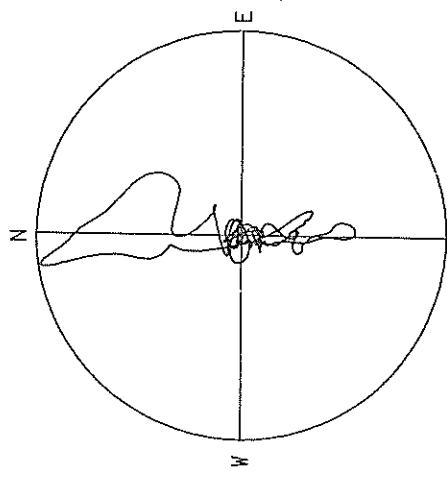

DISPLACEMENT
R=5.00 CM
MAX=4.94 CM

F-95 YAMASHITA-F

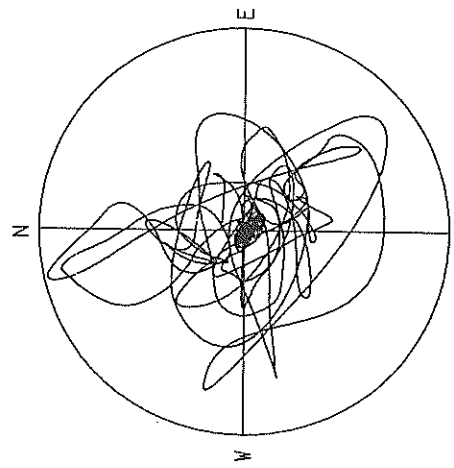

VELOCITY
R=10.0 CM/SEC.
MAX=9.9 CM/SEC.

F-95 YAMASHITA-F

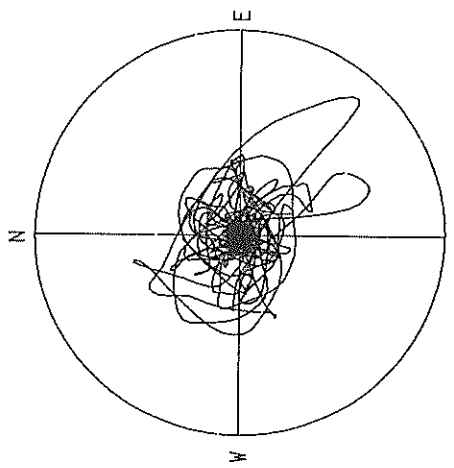

ACCELERATION
R=150.0 GAL
MAX=132.3 GAL

RECORD NUMBER
STATION

F-98

KAWASAKI-F

EARTHQUAKE DATA

 DATA AND TIME *****
 LOCATION OF HYPOCENTER *****
 EPICENTRAL REGION *****
 LATITUDE *****
 LONGITUDE *****
 DEPTH *****
 MAGNITUDE *****

11: 8 DEC.17,1987

CHIBA-KEN-TOHO-OKI

35°22' N

140°30' E

58KM

6.7

PEAK VALUES OF COMPONENTS

 N S E W U D HORIZONTAL*

PARAMETER OF THE VARIABLE FILTER

 FC (HZ) 0.061 0.079 0.110

 MAXIMUM ACCELERATION (GAL)

 SMAC-B2 EQUIVALENT
 ORIGINAL 78.0 69.7 22.2 78.0
 CORRECTED 86.4 89.5 26.6 91.2

 MAXIMUM VELOCITY (CM/SEC)

 FIXED FILTER
 VARIABLE FILTER 18.73 9.37 3.07 18.86
 MAXIMUM DISPLACEMENT (CM)

 FIXED FILTER
 VARIABLE FILTER 20.07 8.90 2.89 20.19

 FIXED FILTER 6.912 2.369 0.680 7.061
 VARIABLE FILTER 5.718 1.925 0.699 5.899

* RESULTANT OF HORIZONTAL COMPONENTS

F-98 KAWASAKI-F

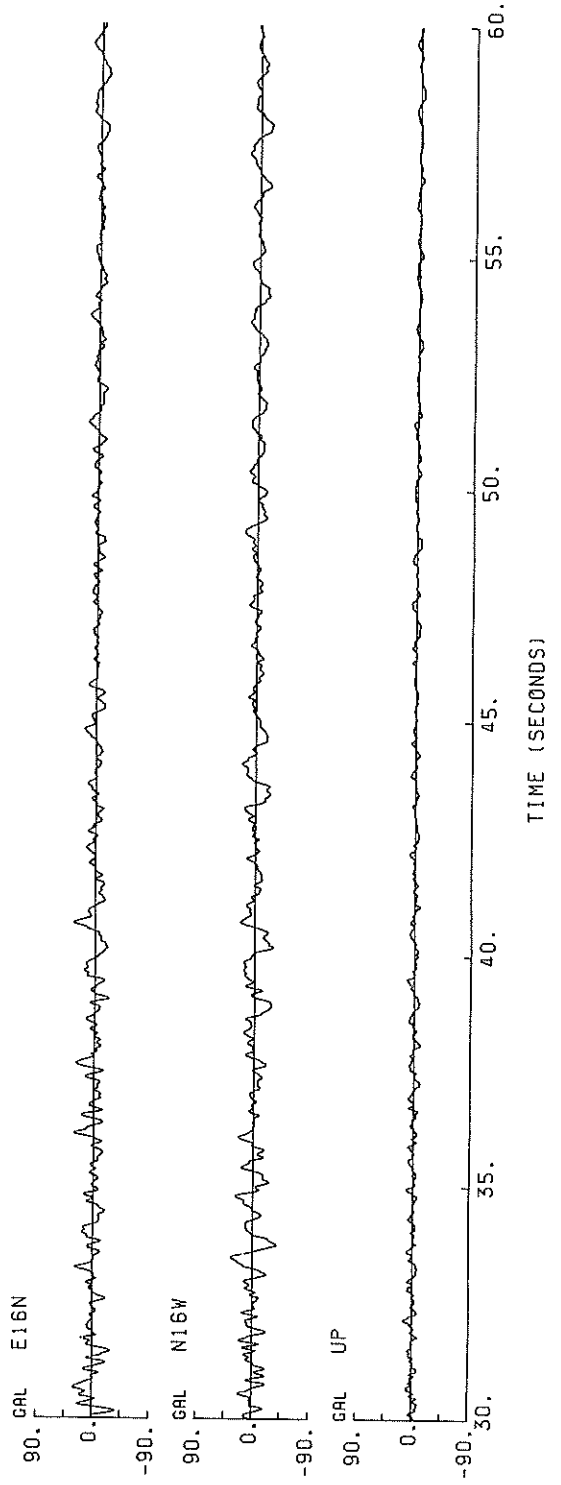
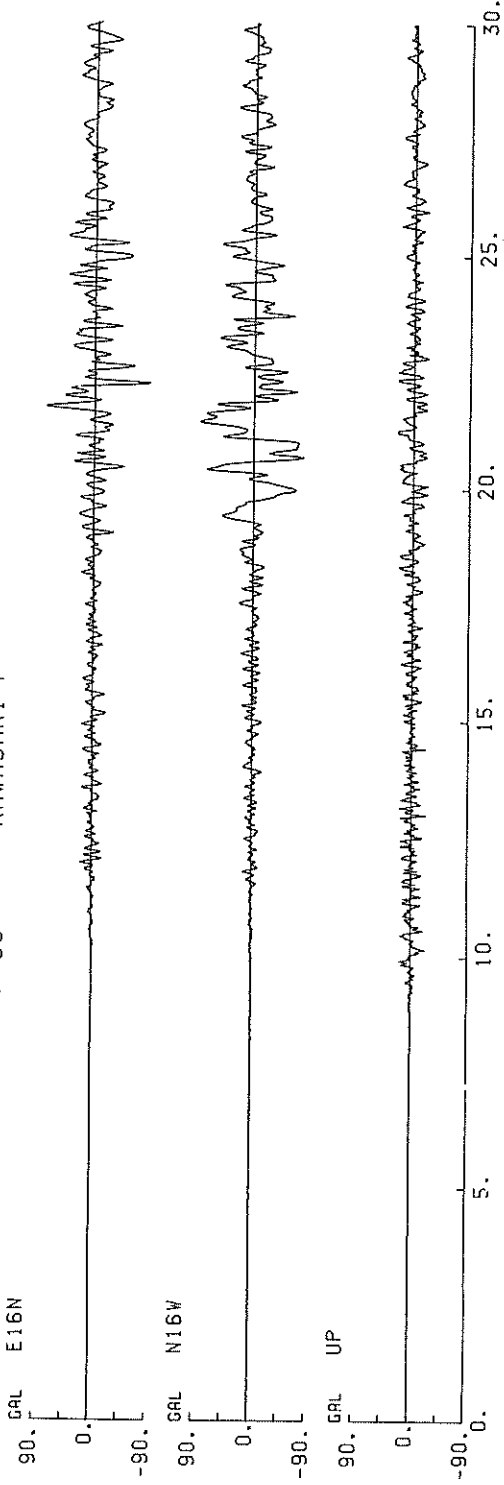

F-98 N16W KAWASAKI-F

SMAC-B2 EQUIVALENT

80.

ACCELERATION (GALS)

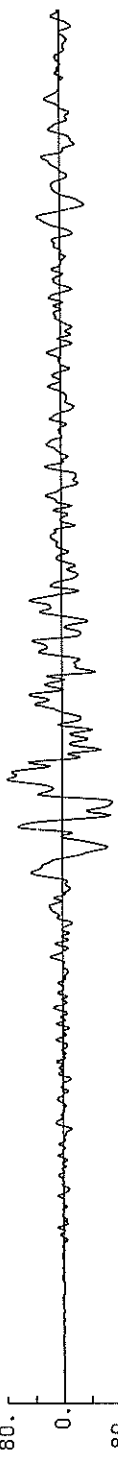

CORRECTED

90.



FIXED FILTER

20.



VARIABLE FILTER (FC=0.073HZ)

-20.



FIXED FILTER

7.

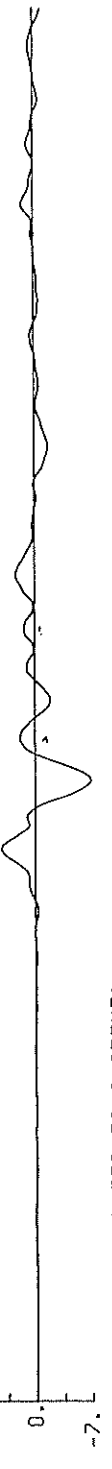

VARIABLE FILTER (FC=0.073HZ)

-7.

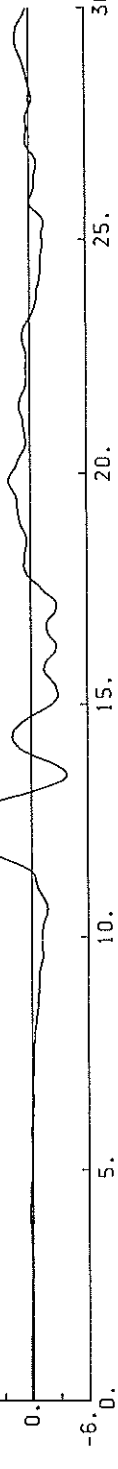

-6.0.

30.

TIME (SECONDS)

F-98 N16W KAWASAKI-F

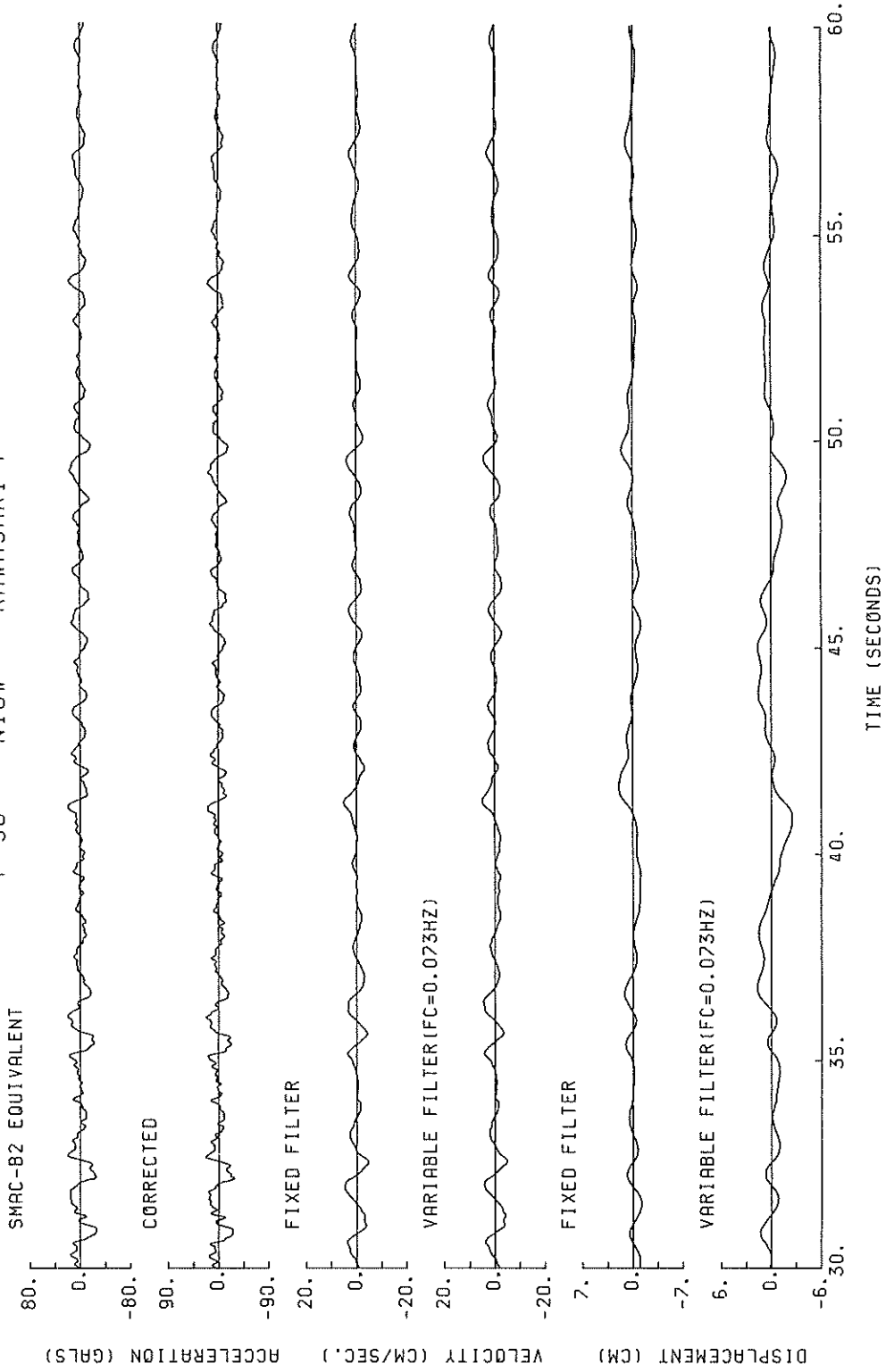

F-98 E16N KAWASAKI-F

SMAC-B2 EQUIVALENT

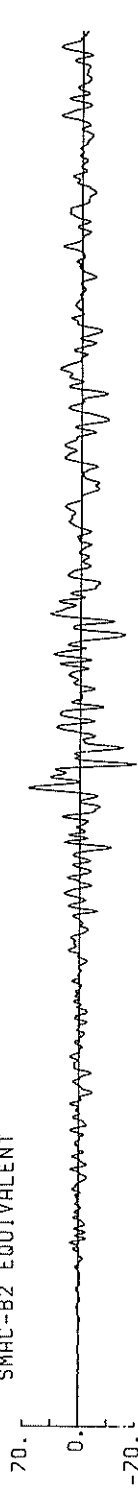

CORRECTED



FIXED FILTER



VARIABLE FILTER (FC=0.079HZ)

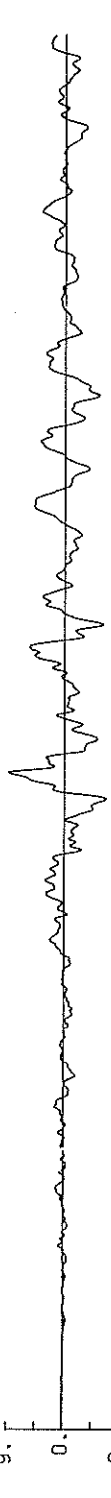

FIXED FILTER



VARIABLE FILTER (FC=0.079HZ)

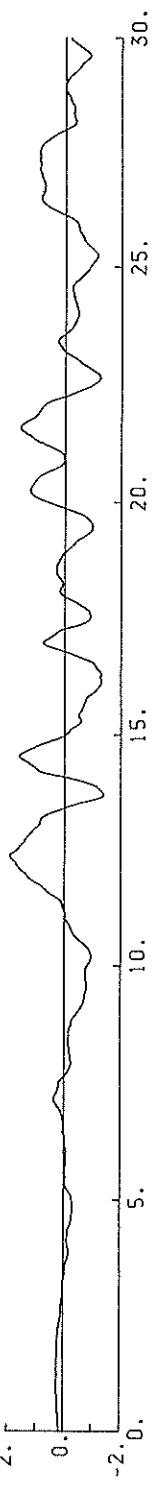

TIME (SECONDS)

5. 10. 15. 20. 25. 30.

F-98 E16N KAWASAKI-F

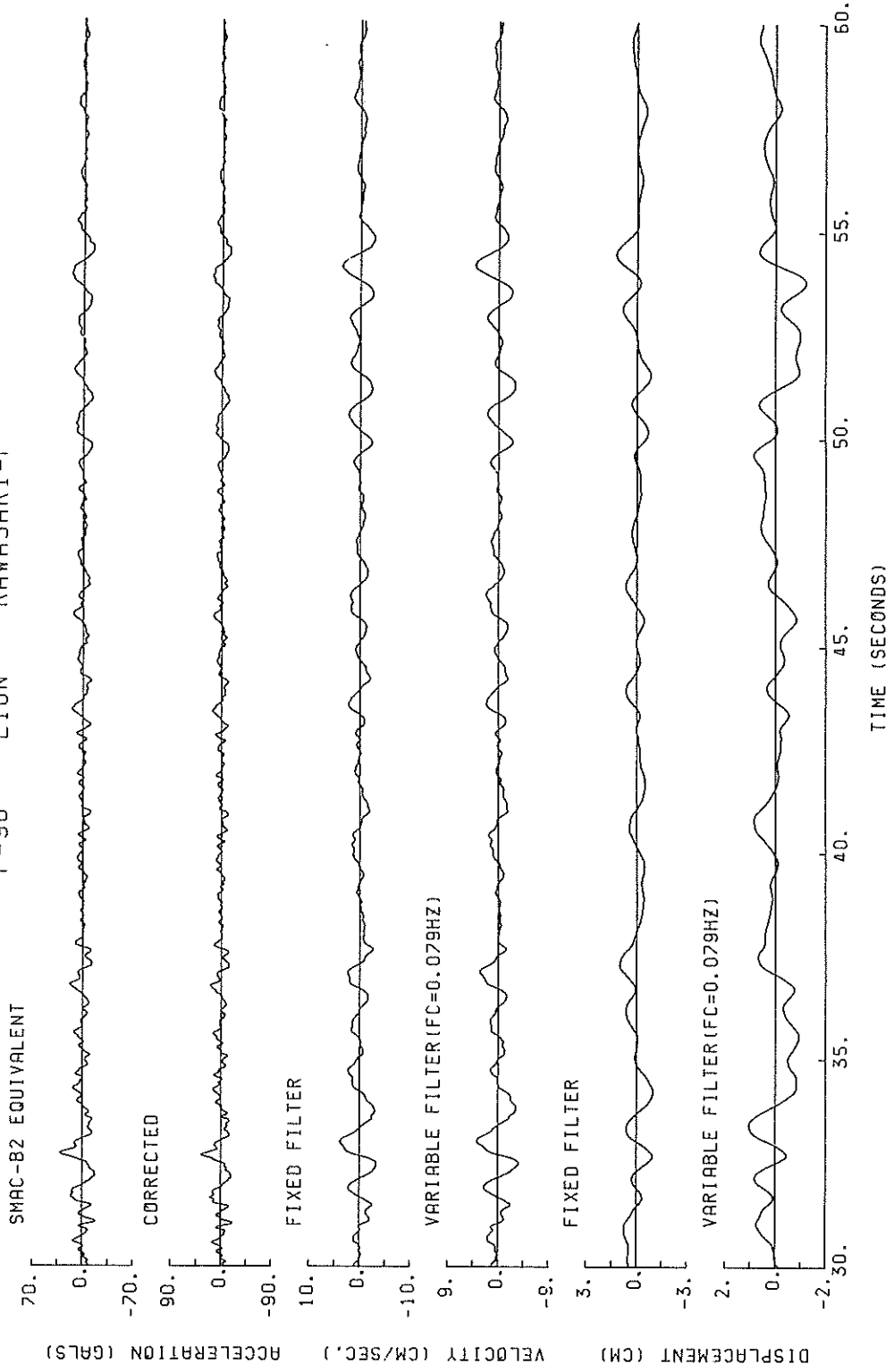

F-98 UP KAWASAKI-F

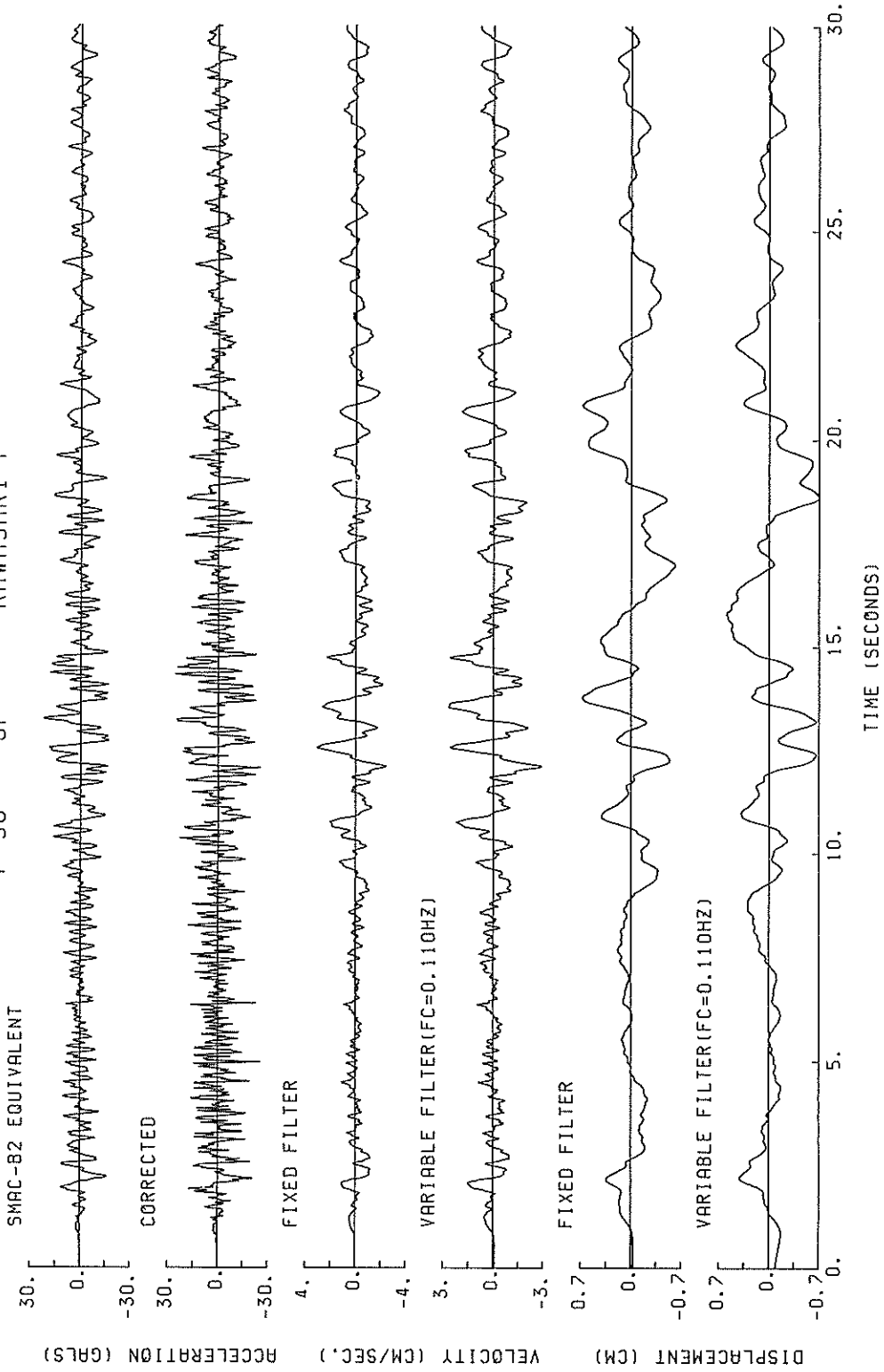

F-98 UP KAWASAKI-F

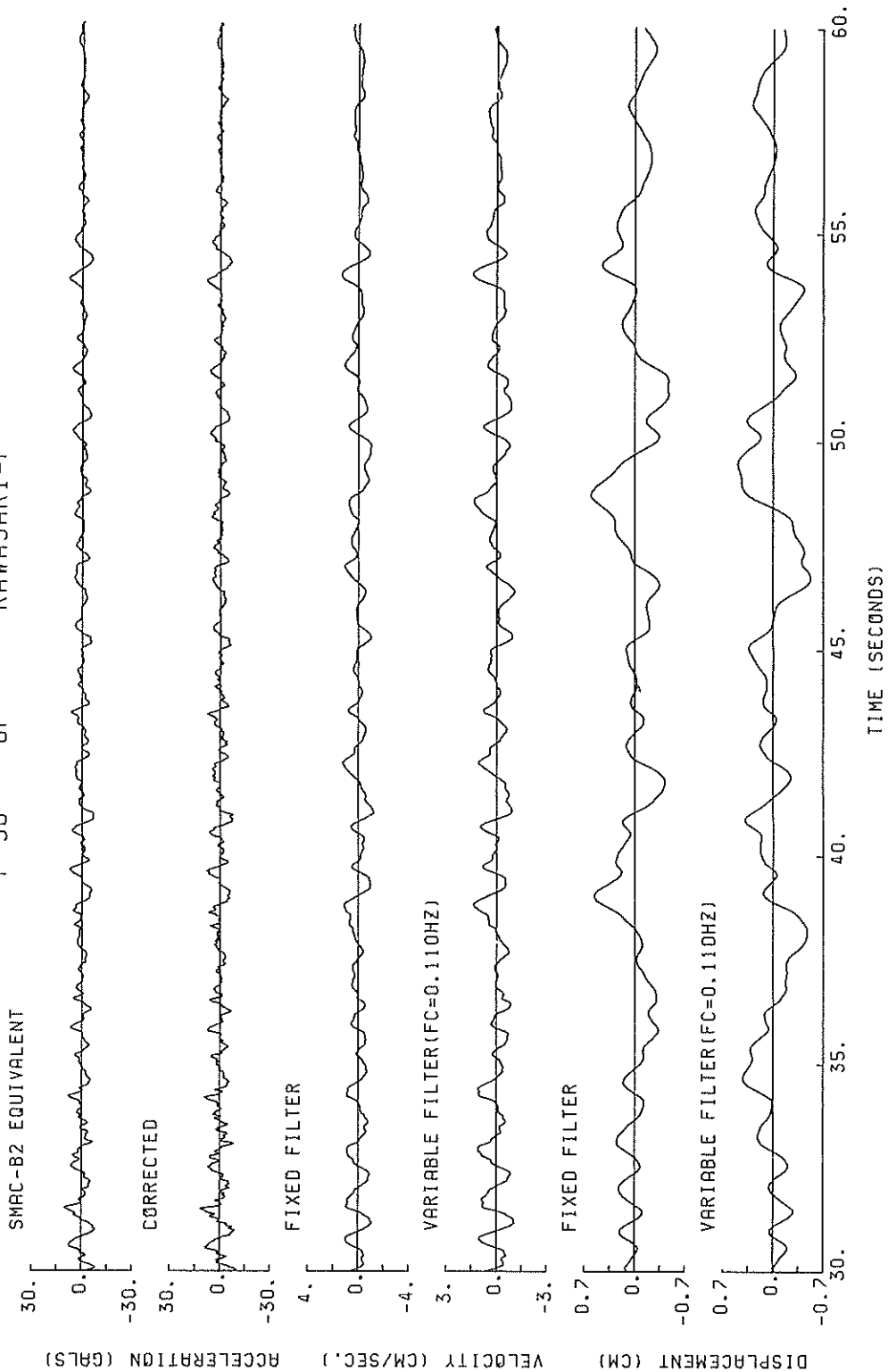

F-98 N16W KAWASAKI-F
(1/FC=16.48SEC.)

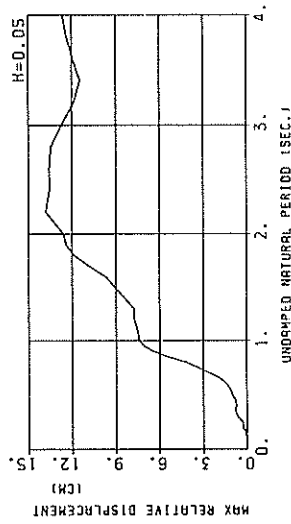
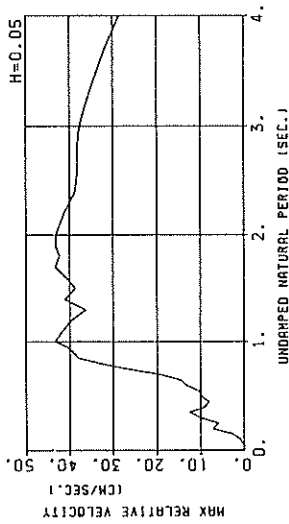
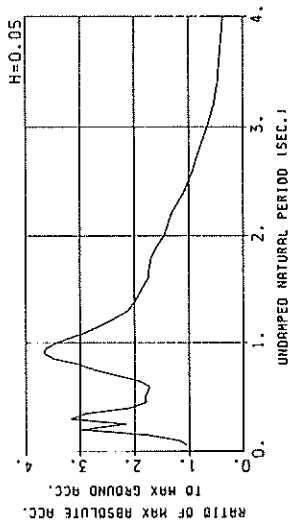

RESPONSE SPECTRA

F-98 E16N KAWASAKI-F
(1/FC=12.66SEC.)

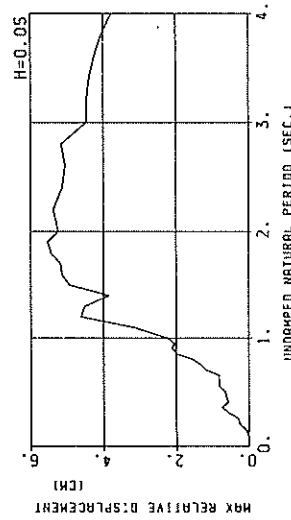
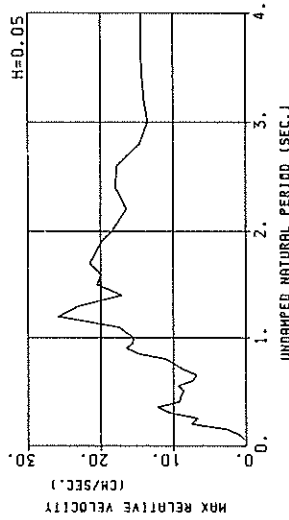
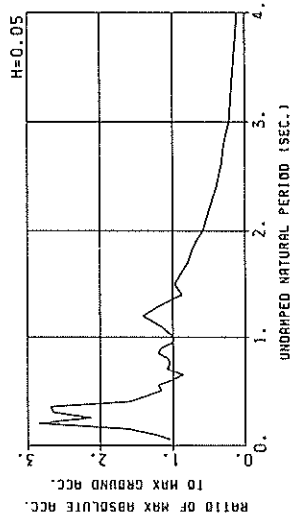

RESPONSE SPECTRA

F-98 UP KAWASAKI-F
(1/FC=9.13 SEC.)

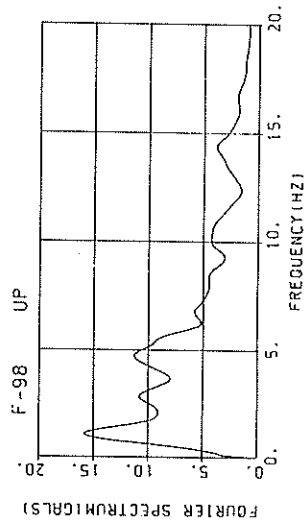
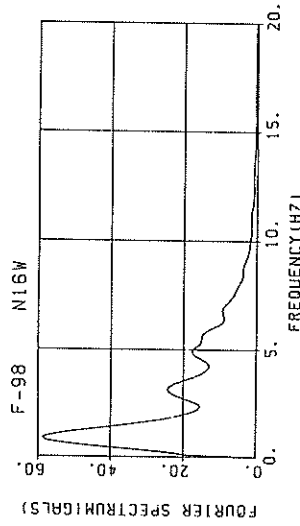
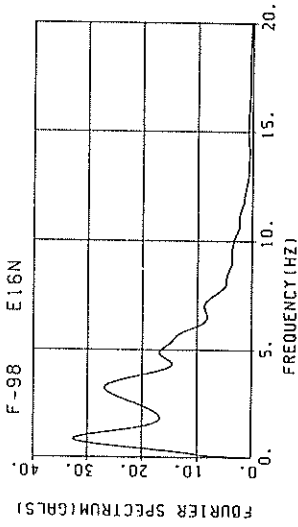
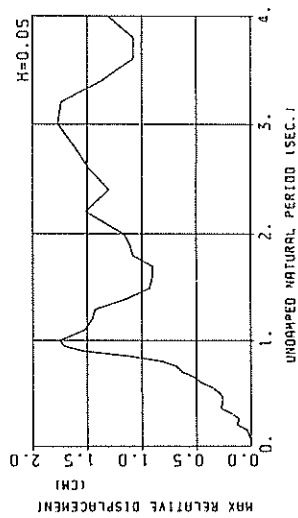
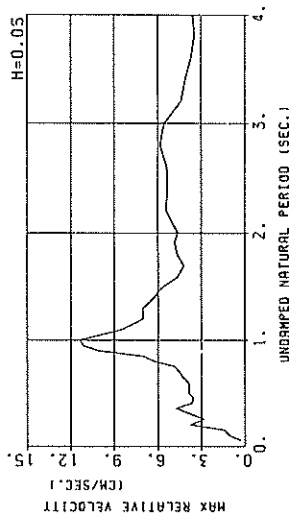
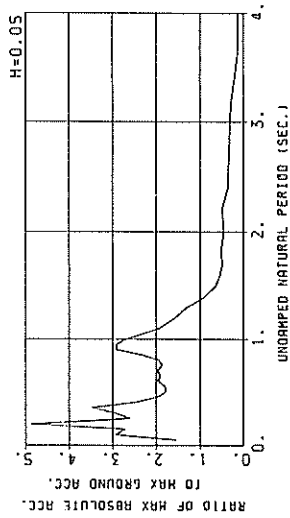

RESPONSE SPECTRA

FOURIER SPECTRA

RESPONSE SPECTRUM

RECORD = F-98
 DATE AND TIME = 1987-12-17-11-9
 TIME LENGTH = 59.99 (SEC)

COMPONENT = E16N
 SIGNAL = GR. ACC.
 SAMPRING INTERVAL = 0.0100(SEC)
 SKIPPED LENGTH = 0.00 (SEC)

STATION = KAWASAKI-F
 MAX-GROUND ACC. = 89.96 (GAL)

PER AA RV RD AA RV RD AA RV RD AA RV RD AA RV RD

DAMPING = 0. DAMPING = 0.025 DAMPING = 0.050 DAMPING = 0.100 DAMPING = 0.250

0.05	133.9	0.48	0.008	92.3	0.14	0.006	92.2	0.14	0.006	92.4	0.14	0.006	92.8	0.13	0.006
0.10	310.4	3.99	0.079	112.2	1.17	0.029	112.1	0.87	0.028	112.9	0.85	0.028	106.8	0.62	0.026
0.15	459.6	18.81	0.262	176.7	3.63	0.101	145.4	2.55	0.083	144.2	2.21	0.081	127.8	1.70	0.069
0.20	1198.8	38.07	1.215	325.3	9.90	0.329	255.6	7.48	0.257	196.9	5.38	0.195	138.4	2.96	0.129
0.25	372.8	14.30	0.590	225.0	7.94	0.355	191.3	6.63	0.301	145.3	4.84	0.326	115.0	3.34	0.166
0.30	1005.8	47.57	2.593	349.9	15.57	0.794	238.0	10.48	0.542	164.4	7.09	0.368	114.4	3.97	0.236
0.35	172.3	26.53	1.484	295.8	14.84	0.918	241.3	12.22	0.745	172.9	8.21	0.526	111.7	4.71	0.306
0.40	230.4	14.77	0.934	143.4	9.14	0.582	141.9	9.15	0.572	120.9	7.84	0.481	95.7	5.25	0.358
0.45	336.3	24.68	1.725	157.7	11.73	0.808	121.6	8.93	0.620	94.7	7.06	0.476	80.0	5.26	0.368
0.50	290.2	22.48	1.838	125.1	10.36	0.790	104.1	8.56	0.656	91.2	7.06	0.565	77.9	5.07	0.440
0.55	310.4	26.74	2.378	121.8	10.97	0.931	107.9	9.33	0.823	91.0	7.25	0.683	75.3	4.94	0.510
0.60	141.2	14.04	1.288	105.2	9.62	0.957	91.5	7.31	0.829	84.4	6.68	0.751	71.7	5.19	0.575
0.65	149.6	14.36	1.801	72.6	7.47	0.776	76.9	6.85	0.818	77.3	6.71	0.806	68.3	5.73	0.632
0.70	177.4	17.65	2.302	119.4	12.58	1.480	96.6	8.54	1.192	77.5	6.97	0.939	64.1	6.50	0.685
0.75	270.0	32.64	3.847	125.5	14.88	1.788	93.6	9.79	1.527	76.6	8.39	1.068	60.4	7.37	0.743
0.80	118.5	15.26	1.921	102.3	11.32	1.657	95.7	11.08	1.544	81.3	10.37	1.292	56.7	8.24	0.801
0.85	172.3	22.86	3.153	127.7	16.62	2.335	108.0	16.49	1.968	84.2	12.40	1.509	53.2	9.01	0.898
0.90	278.0	39.51	5.705	139.9	20.54	2.868	103.9	16.49	2.120	81.5	13.64	1.634	51.6	9.63	0.995
0.95	217.9	32.26	4.980	109.6	15.89	2.501	90.0	15.55	2.046	75.1	13.90	1.681	51.4	10.02	1.086
1.00	323.5	50.66	8.195	112.6	17.06	2.850	88.8	15.48	2.241	71.2	13.91	1.796	50.6	10.22	1.174
1.10	453.8	77.69	13.910	156.1	26.48	4.781	103.1	17.50	3.145	77.5	13.99	2.327	50.9	10.14	1.385
1.20	415.4	79.72	15.153	171.3	34.97	6.240	127.1	25.87	4.616	82.6	16.70	2.962	50.3	9.54	1.607
1.30	277.3	58.09	11.870	132.2	28.48	5.651	106.1	23.08	4.513	73.6	15.91	3.069	46.6	9.15	1.771
1.40	161.3	34.78	8.009	104.7	20.78	5.188	77.9	17.06	3.843	58.7	13.44	2.864	43.2	8.86	1.949
1.50	253.6	61.13	14.454	118.4	28.24	6.741	87.0	20.50	4.934	56.8	14.89	3.170	40.7	9.09	2.118
1.60	126.9	33.48	8.231	97.6	24.80	6.321	79.7	19.93	5.138	56.2	14.72	3.565	38.3	9.65	2.264
1.70	141.5	38.72	10.355	86.9	25.48	6.352	71.1	21.49	5.179	50.9	15.25	3.672	37.3	10.11	2.384
1.80	151.1	43.65	12.399	90.4	27.06	7.408	66.7	20.64	5.441	46.5	14.17	3.690	35.5	10.46	2.469
1.90	138.6	42.57	12.672	81.1	26.33	7.400	61.0	19.89	5.539	43.3	14.05	3.820	33.2	10.69	2.512
2.00	93.1	33.02	9.433	68.2	24.14	6.898	52.2	18.37	5.248	38.8	13.96	3.790	31.9	10.77	2.509
2.20	61.6	22.79	7.551	51.8	19.19	6.338	44.2	16.38	5.383	34.2	13.08	4.021	29.4	10.61	2.659
2.40	74.5	11.91	10.868	41.5	20.39	6.035	35.4	17.99	5.128	26.9	14.25	3.811	26.8	10.12	2.765
2.60	39.1	22.06	6.694	33.9	19.69	5.750	29.7	17.73	5.082	23.4	14.70	3.910	24.4	9.78	2.817
2.80	35.9	18.91	7.122	29.7	15.56	5.877	26.3	14.59	5.159	21.6	12.94	4.066	22.1	9.93	2.822
3.00	46.8	22.83	10.673	27.7	16.96	6.294	19.9	13.56	4.451	17.5	12.63	3.901	19.9	10.46	2.842
3.20	45.1	24.58	11.697	20.9	14.49	5.377	17.4	13.98	4.445	15.8	13.07	3.956	17.9	10.88	2.881
3.40	21.2	15.18	6.220	15.9	14.70	4.640	14.1	14.22	4.384	14.1	13.35	3.922	16.1	11.20	2.887
3.60	14.5	15.28	4.758	13.8	14.81	4.493	13.3	14.36	4.250	12.5	13.52	3.816	14.4	11.43	2.864
3.80	12.3	15.28	4.509	11.8	14.83	4.266	11.4	14.41	4.001	10.9	13.60	3.641	12.9	11.58	2.755
4.00	10.4	15.19	4.196	9.9	14.78	3.970	9.6	14.37	3.763	9.4	13.60	3.402	11.5	11.66	2.626

PER = PERIOD (SEC) AA = ABSOLUTE ACC. (GAL) RV = RELATIVE VELOCITY (CM/SEC) RD = RELATIVE DISPLACEMENT (CM)

RESPONSE SPECTRUM

RECORD = F-98				COMPONENT = N16W				SIGNAL = GR. ACC.				CORRECTION =				STATION = KAWASAKI-F			
DATE AND TIME = 1987-12-17-11-9				SAMPLE INTERVAL = 0.0100(SEC)				MAX. GROUND ACC. =				85.16 (GAL)							
TIME LENGTH = 59.99 (SEC)				DAMPING = 0.025				DAMPING = 0.050				DAMPING = 0.100				DAMPING = 0.250			
				SKIP LENGTH = 0.00 (SEC)															
PER	AA	RV	RD	AA	RV	RD	AA	RV	RD	AA	RV	RD	AA	RV	RD				
0.05	124.8	0.56	0.008	89.1	0.15	0.006	87.7	0.15	0.006	87.6	0.14	0.006	87.5	0.13	0.006				
0.10	225.1	2.70	0.057	109.8	0.88	0.028	102.4	0.86	0.026	97.4	0.82	0.025	93.1	0.66	0.023				
0.15	719.4	17.16	0.410	189.2	3.70	0.108	152.4	2.72	0.087	134.7	2.43	0.076	110.8	1.55	0.060				
0.20	1006.0	31.74	1.019	381.1	11.13	0.303	256.6	7.14	0.260	170.0	4.15	0.171	116.7	2.36	0.111				
0.25	600.5	23.33	0.951	223.4	7.79	0.354	185.3	5.92	0.293	149.3	4.27	0.234	116.0	2.67	0.176				
0.30	754.2	35.80	1.719	323.5	13.33	0.736	222.8	9.80	0.617	201.6	7.00	0.554	128.1	4.30	0.273				
0.35	882.4	48.54	2.738	324.8	15.75	1.087	248.2	12.61	0.766	189.1	9.04	0.578	135.1	5.14	0.385				
0.40	292.7	16.11	1.186	194.9	9.91	0.788	179.8	8.91	0.725	163.0	7.91	0.651	129.8	5.95	0.477				
0.45	214.9	13.91	1.102	154.6	7.67	0.793	153.7	8.04	0.786	146.4	8.00	0.738	122.0	6.75	0.567				
0.50	479.2	37.46	3.034	164.3	12.71	1.040	155.5	9.75	0.981	142.5	9.05	0.888	116.4	7.62	0.670				
0.55	227.0	19.08	1.739	151.5	11.22	1.160	151.0	10.30	1.153	140.3	10.04	1.060	112.7	8.59	0.796				
0.60	441.6	41.44	4.027	208.2	19.12	1.896	148.6	13.07	1.351	142.2	11.32	1.282	111.6	9.87	0.961				
0.65	707.7	72.85	7.574	202.6	20.36	2.165	185.1	14.56	1.761	153.0	13.51	1.619	115.2	10.86	1.174				
0.70	350.0	37.10	4.344	218.5	20.49	2.709	201.0	19.23	2.486	172.9	16.95	2.121	121.4	12.00	1.430				
0.75	401.7	47.44	5.723	260.9	30.13	3.715	234.0	26.60	3.322	192.8	21.30	2.714	127.3	12.88	1.718				
0.80	448.9	56.79	7.277	309.6	38.59	5.013	281.5	33.28	4.225	209.2	25.34	3.547	132.2	13.65	2.018				
0.85	459.4	57.48	8.407	364.1	45.96	6.654	300.1	38.10	5.468	219.5	27.78	3.956	135.2	14.18	2.288				
0.90	660.7	93.98	13.556	381.6	47.99	7.819	316.0	39.21	6.459	231.6	28.33	4.684	134.5	14.21	2.551				
0.95	644.5	98.38	14.735	368.5	52.21	8.417	311.1	40.48	7.086	233.5	28.15	5.259	136.1	13.97	2.918				
1.00	623.4	97.90	15.790	350.9	53.03	8.876	294.2	43.52	7.416	236.5	30.57	5.641	138.1	15.23	3.230				
1.10	328.3	55.21	10.062	285.7	47.68	8.746	246.4	41.66	7.518	193.0	31.92	5.807	133.0	17.30	3.669				
1.20	606.0	116.43	22.104	243.6	44.35	8.876	212.5	39.72	7.717	167.3	32.51	5.986	121.8	19.64	3.968				
1.30	422.8	88.05	18.101	218.6	47.88	9.345	181.8	36.20	7.747	147.9	30.13	6.244	109.6	20.36	4.291				
1.40	404.1	90.45	20.061	205.3	50.24	10.177	169.9	41.09	8.388	134.1	28.67	6.519	100.9	20.17	4.600				
1.50	380.8	92.45	21.702	190.0	44.84	10.814	180.6	38.75	9.098	122.8	29.26	6.890	96.0	19.66	4.909				
1.60	385.8	99.91	25.019	173.0	46.58	11.205	150.5	40.68	9.708	121.0	31.03	7.685	91.8	19.46	5.244				
1.70	286.2	78.07	20.955	169.3	50.36	12.382	148.7	43.29	10.840	117.1	32.67	8.420	88.3	20.32	5.611				
1.80	274.7	79.61	22.545	166.2	49.22	13.616	145.5	42.33	11.857	113.5	34.43	9.095	85.2	20.89	5.994				
1.90	255.4	78.53	23.352	157.5	48.24	14.082	136.6	43.21	12.413	106.7	35.02	9.558	82.3	21.13	6.382				
2.00	185.7	61.07	18.812	146.9	49.23	14.864	125.3	43.07	12.631	103.5	33.89	10.264	79.2	21.90	6.765				
2.20	146.8	55.96	17.993	127.8	47.75	15.843	113.6	41.25	13.827	92.4	34.21	11.009	72.3	23.76	7.422				
2.40	120.5	48.09	17.581	105.7	43.08	15.399	93.6	38.75	13.560	80.4	32.30	11.311	64.3	25.13	7.813				
2.60	96.1	46.74	16.447	86.3	42.09	14.762	79.6	38.09	13.554	69.6	32.92	11.584	56.4	25.88	7.905				
2.80	83.2	43.30	16.530	73.9	40.61	14.648	68.3	38.25	13.445	59.4	34.23	11.492	49.8	26.05	7.971				
3.00	65.9	41.61	15.025	60.6	39.57	13.808	56.3	37.66	12.745	50.0	34.27	10.997	43.2	26.48	7.563				
3.20	53.1	38.90	13.767	49.4	37.55	12.788	46.1	36.18	11.874	41.1	33.66	10.284	37.6	26.67	7.693				
3.40	50.4	36.49	14.751	40.8	35.59	11.902	39.4	34.47	11.400	37.0	32.30	10.441	35.5	26.52	8.168				
3.60	44.4	34.67	14.585	38.2	33.66	12.994	36.9	32.70	11.932	34.7	30.90	10.911	33.4	26.08	8.561				
3.80	38.7	32.22	14.161	35.7	31.43	12.394	34.3	30.70	12.363	32.5	29.31	11.274	31.4	25.46	8.876				
4.00	34.5	29.33	13.980	32.8	28.92	13.246	31.7	28.51	12.600	30.1	27.62	11.503	29.4	24.72	9.115				

PER = PERIOD (SEC) AA = ABSOLUTE ACC. (GAL) RV = RELATIVE VELOCITY (CM/SEC) RD = RELATIVE DISPLACEMENT (CM)

RESPONSE SPECTRUM

RECORD = F-98
 DATE AND TIME = 1987-12-17-11-9
 TIME LENGTH = 59.99 (SEC)

COMPONENT = UP
 SIGNAL = GR. ACC.
 INTERVAL = 0.0100(SEC)
 SKIPPED LENGTH = 0.00 (SEC)

CORRECTION =
 MAX-GROUND ACC. = 25.89 (GAL)

STATION = KAWASAKI-F

PER	DAMPING = 0.				DAMPING = 0.025				DAMPING = 0.050				DAMPING = 0.100				DAMPING = 0.250			
	AA	RV	RD	AA	RV	RD	AA	RV	RD	AA	RV	RD	AA	RV	RD	AA	RV	RD		
0.05	155.9	1.07	0.010	45.6	0.25	0.003	39.3	0.21	0.002	38.5	0.17	0.002	35.6	0.14	0.002	35.6	0.14	0.002		
0.10	336.6	5.22	0.085	105.8	1.56	0.027	76.1	1.08	0.019	50.9	0.75	0.013	39.3	0.46	0.009	39.3	0.46	0.009		
0.15	292.7	6.89	0.167	93.9	2.02	0.053	56.4	1.43	0.040	56.4	1.05	0.032	45.5	0.76	0.023	45.5	0.76	0.023		
0.20	419.5	13.27	0.425	164.8	5.04	0.166	126.0	3.74	0.127	83.8	2.41	0.083	42.1	1.19	0.042	42.1	1.19	0.042		
0.25	165.9	6.88	0.233	91.2	3.79	0.144	67.4	2.80	0.107	53.0	1.80	0.082	38.5	1.25	0.055	38.5	1.25	0.055		
0.30	187.9	8.80	0.428	111.0	5.36	0.255	75.8	3.70	0.172	52.0	2.53	0.116	35.7	1.51	0.075	35.7	1.51	0.075		
0.35	381.9	21.31	1.185	134.0	7.43	0.415	89.8	4.73	0.276	59.0	2.88	0.180	35.2	1.48	0.100	35.2	1.48	0.100		
0.40	134.3	8.23	0.336	73.7	4.19	0.299	64.0	3.61	0.258	49.0	2.71	0.195	31.2	1.61	0.120	31.2	1.61	0.120		
0.45	114.7	7.76	0.588	64.0	4.54	0.328	50.5	3.57	0.258	37.8	2.60	0.191	29.5	1.76	0.143	29.5	1.76	0.143		
0.50	118.4	9.29	0.750	57.8	4.82	0.365	46.1	3.90	0.290	37.0	2.92	0.229	29.6	1.82	0.175	29.6	1.82	0.175		
0.55	168.1	14.62	1.288	58.5	4.93	0.448	46.6	3.83	0.356	38.1	2.85	0.288	30.9	1.97	0.218	30.9	1.97	0.218		
0.60	98.8	9.31	0.901	53.0	4.17	0.485	50.8	3.93	0.462	43.2	3.19	0.386	32.0	2.33	0.263	32.0	2.33	0.263		
0.65	90.8	9.13	0.972	52.7	5.06	0.565	49.2	4.31	0.524	42.4	3.52	0.444	31.9	2.60	0.302	31.9	2.60	0.302		
0.70	150.7	16.25	1.871	60.5	6.65	0.749	51.0	4.51	0.630	42.1	3.54	0.513	31.1	2.83	0.337	31.1	2.83	0.337		
0.75	106.6	12.67	1.519	57.5	6.64	0.818	48.3	4.59	0.684	42.7	3.80	0.596	30.0	3.04	0.370	30.0	3.04	0.370		
0.80	217.2	27.60	3.521	68.7	8.50	1.112	50.5	6.28	0.815	44.2	4.68	0.700	29.1	3.35	0.410	29.1	3.35	0.410		
0.85	126.1	16.98	2.307	69.1	8.76	1.262	40.5	7.04	1.102	47.2	6.03	0.848	27.8	3.84	0.442	27.8	3.84	0.442		
0.90	301.5	43.08	6.186	97.6	13.65	2.000	75.7	10.10	1.543	51.7	7.41	1.036	27.7	4.20	0.480	27.7	4.20	0.480		
0.95	150.9	23.87	5.449	97.4	14.18	2.224	69.7	11.17	1.717	50.3	7.89	1.129	26.1	4.37	0.519	26.1	4.37	0.519		
1.00	211.4	33.66	5.356	90.5	14.83	2.290	65.7	11.42	1.755	47.0	7.89	1.171	24.3	4.34	0.538	24.3	4.34	0.538		
1.10	66.3	12.06	2.032	54.0	9.58	1.652	49.8	8.49	1.516	38.4	6.54	1.157	22.1	4.18	0.594	22.1	4.18	0.594		
1.20	138.1	26.55	5.039	43.8	8.97	1.597	40.1	7.03	1.452	33.2	5.75	1.172	21.1	4.00	0.662	21.1	4.00	0.662		
1.30	126.5	26.08	5.417	41.3	8.90	1.764	33.5	7.05	1.427	26.8	5.61	1.111	19.3	3.67	0.671	19.3	3.67	0.671		
1.40	83.9	19.24	4.165	29.1	7.19	1.441	23.3	6.31	1.150	19.7	5.19	0.959	16.8	3.38	0.662	16.8	3.38	0.662		
1.50	40.8	10.27	2.323	20.8	6.40	1.184	16.3	5.71	0.928	14.4	4.87	0.799	14.2	3.25	0.599	14.2	3.25	0.599		
1.60	31.5	7.86	2.040	19.0	5.05	1.227	14.0	4.62	0.901	11.6	4.35	0.708	12.2	3.35	0.613	12.2	3.35	0.613		
1.70	29.1	8.62	2.134	19.2	5.44	1.404	13.8	4.48	1.005	10.6	4.09	0.732	11.5	3.35	0.643	11.5	3.35	0.643		
1.80	29.0	8.76	2.377	17.1	5.49	1.401	13.3	4.64	1.082	10.5	4.20	0.810	10.9	3.37	0.674	10.9	3.37	0.674		
1.90	19.2	6.17	1.759	14.7	5.39	1.345	12.2	4.81	1.112	10.5	4.24	0.904	10.4	3.40	0.702	10.4	3.40	0.702		
2.00	23.8	8.78	2.413	15.6	5.72	1.580	11.6	4.61	1.168	10.1	4.12	0.969	9.9	3.53	0.725	9.9	3.53	0.725		
2.20	30.1	11.42	3.689	15.8	6.69	1.933	12.5	5.41	1.514	9.2	4.50	1.066	8.8	3.81	0.746	8.8	3.81	0.746		
2.40	19.3	11.4	2.816	11.4	5.82	1.661	9.1	5.34	1.302	7.7	4.88	1.042	7.6	4.02	0.725	7.6	4.02	0.725		
2.60	10.2	5.36	1.749	9.6	5.46	1.631	8.8	5.59	1.487	7.3	5.06	1.197	6.4	4.14	0.697	6.4	4.14	0.697		
2.80	12.6	7.08	2.502	10.0	6.36	1.977	8.3	5.86	1.625	6.5	5.20	1.194	5.3	4.09	0.718	5.3	4.09	0.718		
3.00	9.4	7.31	2.882	9.4	6.05	2.142	7.9	5.53	1.774	6.3	4.94	1.330	5.0	3.95	0.816	5.0	3.95	0.816		
3.20	12.6	6.05	2.431	7.8	4.57	2.023	6.8	4.35	1.735	5.7	4.31	1.360	4.9	3.95	0.869	4.9	3.95	0.869		
3.40	10.3	5.86	3.018	4.8	4.47	1.386	4.7	4.05	1.352	4.6	3.73	1.228	4.6	3.78	0.884	4.6	3.78	0.884		
3.60	5.5	3.75	1.806	3.8	3.73	1.254	3.4	3.68	1.079	3.7	3.44	1.095	4.2	3.62	0.878	4.2	3.62	0.878		
3.80	4.9	3.35	1.796	3.2	3.43	1.181	3.0	3.48	1.063	3.2	3.40	1.036	3.9	3.48	0.861	3.9	3.48	0.861		
4.00	3.4	3.70	1.370	3.4	3.65	1.372	3.2	3.59	1.301	2.9	3.43	1.119	3.6	3.36	0.836	3.6	3.36	0.836		

PER = PERIOD (SEC) AA = ABSOLUTE ACC. (GAL) RV = RELATIVE VELOCITY (CM/SEC) RD = RELATIVE DISPLACEMENT (CM)

F-98 KAWASAKI-F

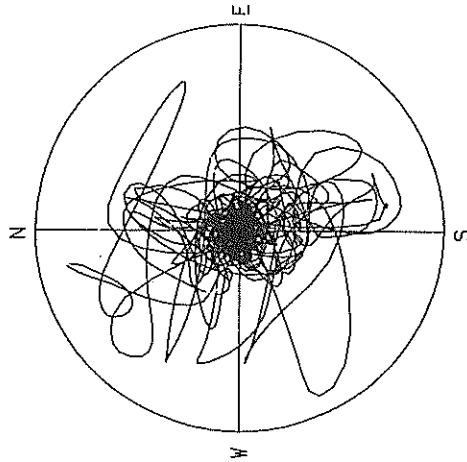

ACCELERATION
R=100.0GAL
MAX=91.2 GAL

F-98 KAWASAKI-F

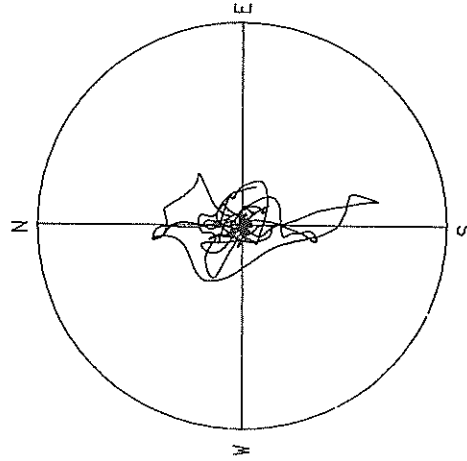

VELOCITY
R=30.0 CM/SEC.
MAX=20.2 CM/SEC.

F-98

KAWASAKI-F

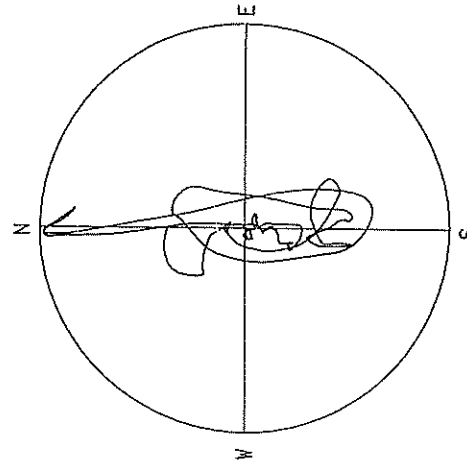

DISPLACEMENT
R=6.00 CM
MAX=5.90 CM

RECORD = S-2106 COMPONENT = NORTH STATION = KOKEN-S
 DATE AND TIME = 1987-12-17-11-08 TOTAL NUMBER OF DATA = 5850
 SAMPLING INTERVAL = 0.010 (SEC) SCAL = 0.10000
 SIGNAL = GR. ACC.
 CONNECTION POINT IN DATA NUMBER = 3012, 5850,

CONTINUED< S-2106 NORTH >
 NO. (1) (2) (3) (4) (5) (6) (7) (8) (9) (10)

NO. (1) (2) (3) (4) (5) (6) (7) (8) (9) (10)

TO BE CONTINUED

CONTINUED(S-2106 NORTH)

	(1)	(2)	(3)	(4)	(5)	(6)	(7)	(8)	(9)	(10)
1030	232	280	307	312	302	280	247	213	189	170
1040	154	137	115	82	44	3	-37	-70	-105	-159
1050	-319	-372	-333	-398	-656	-513	-537	-525	-498	-447
1060	-387	-343	-319	-309	-302	-291	-282	-208	-115	19
1070	157	250	310	364	410	458	511	559	621	679
1080	703	711	704	664	588	486	363	193	15	-152
1090	-293	-370	-422	-464	-487	-491	-475	-438	-381	-303
1100	-198	-103	-43	-20	-16	-25	-54	-83	-118	-156
1110	-210	-280	-331	-358	-363	-346	-301	-231	-144	-99
1120	64	123	185	224	237	235	222	191	166	29
1130	56	21	5	5	57	94	153	226	314	422
1140	527	588	619	622	598	544	461	365	241	86
1150	-89	-257	-372	-475	-533	-546	-514	-439	-330	-203
1160	-73	75	236	320	336	333	316	280	236	201
1170	165	136	111	82	55	35	21	7	-4	-16
1180	-36	-58	-81	-94	-86	-60	-29	3	15	11
1190	-11	-42	-59	-57	-35	4	43	70	86	100
1200	112	123	133	144	153	155	149	126	82	34
1210	-13	-61	-105	-146	-181	-208	-228	-239	-245	-242
1220	-233	-219	-204	-190	-174	-159	-149	-146	-144	-143
1230	-132	-98	-44	14	79	134	166	180	181	171
1240	151	110	52	0	-36	-48	-61	-23	-1	14
1250	21	8	-30	-77	-324	-159	-180	-138	-138	-136
1260	-185	-190	-203	-222	-238	-240	-227	-203	-172	-137
1270	-99	-49	14	83	157	222	252	260	262	256
1280	247	240	237	233	222	189	123	54	-6	-64
1290	-99	-111	-115	-119	-123	-127	-136	-144	-149	-151
1300	-148	-145	-141	-135	-130	-126	-123	-119	-117	-113
1310	-102	-72	-35	5	49	66	71	71	58	26
1320	-16	-63	-94	-100	-72	-15	41	101	144	159
1330	157	136	95	53	32	37	59	85	102	104
1340	94	63	20	-23	-56	-63	-50	-19	23	66
1350	110	161	202	228	244	252	254	246	226	181
1360	115	57	8	-39	-83	-108	-116	-112	-103	-94
1370	-88	-82	-84	-84	-83	-85	-88	-87	-82	-71
1380	-47	-19	10	52	99	133	131	135	134	130
1390	122	109	87	64	34	-13	-62	-98	-110	-110
1400	-107	-107	-112	-123	-137	-147	-149	-141	-115	-76
1410	-35	7	45	77	104	125	143	158	167	171
1420	164	142	111	79	48	16	-16	-44	-69	-94
1430	-115	-133	-147	-158	-168	-173	-175	-175	-173	-173
1440	-166	-152	-127	-94	-53	-11	37	100	162	209
1450	250	267	269	258	227	182	129	82	52	75
1460	10	-1	-14	-26	-40	-52	-60	-66	-70	-75
1470	-81	-81	-77	-63	-41	-22	-10	-6	-4	-5
1480	-5	-4	1	5	9	10	8	6	3	0
1490	-1	-1	2	10	21	32	44	55	59	60
1500	60	52	30	6	-12	-25	-33	-34	-30	-23
1510	-14	-7	-2	-2	7	-7	-15	-25	-28	-32
1520	4	29	55	76	93	111	120	126	131	135
1530	137	137	136	136	138	139	139	141	143	145
1540	146	147	146	137	113	82	53	32	22	24
1550	30	37	47	56	68	84	105	125	141	148
1560	143	123	89	53	24	-4	-32	-55	-74	-91

TO BE CONTINUED

CONTINUED(S-2106 NORTH)

	(1)	(2)	(3)	(4)	(5)	(6)	(7)	(8)	(9)	(10)
1570	-103	-107	-106	-100	-92	-81	-68	-54	-40	-23
1580	-5	7	17	21	22	21	20	19	15	11
1590	8	2	-3	-7	-16	-27	-37	-45	-60	-76
1600	-138	-163	-180	-183	-161	-117	-71	-22	29	76
1610	113	136	147	152	150	145	135	118	96	72
1620	47	24	4	-13	-32	-51	-68	-85	-102	-111
1630	-102	-65	-19	20	44	64	78	83	80	83
1640	76	69	58	46	25	0	-26	-107	-68	-82
1650	-96	-107	-114	-119	-125	-127	-120	-107	-91	-76
1660	-60	-43	-28	-11	7	24	40	57	71	79
1670	81	79	79	85	97	104	101	77	33	-15
1680	-68	-117	-156	-172	-169	-153	-119	-107	-107	-107
1690	-97	-97	-95	-89	-79	-55	-14	18	33	37
1700	35	30	25	23	29	41	54	66	73	76
1710	65	39	14	4	-22	-32	-32	-32	-35	-42
1720	-52	-64	-73	-74	-69	-54	-35	-15	7	24
1730	40	55	69	82	92	97	99	99	94	83
1740	69	52	35	16	-7	-33	-59	-77	-93	-111
1750	-127	-139	-152	-161	-167	-169	-169	-165	-155	-139
1760	-119	-94	-67	-38	-7	14	28	36	37	34
1770	29	22	13	4	-3	-9	-12	-12	-11	-9
1780	8	-10	-15	-20	-26	-30	-30	-26	-19	-10
1790	-2	4	15	18	24	26	30	32	38	45
1800	56	65	70	72	69	61	51	41	36	34
1810	38	44	54	66	79	94	110	125	136	139
1820	133	121	103	84	66	49	35	23	11	-4
1830	-19	-33	-43	-51	-58	-63	-67	-70	-70	-67
1840	-60	-52	-41	-31	-24	-21	-21	-26	-35	-48
1850	-61	-73	-84	-93	-100	-105	-109	-110	-110	-109
1860	-104	-101	-99	-97	-94	-89	-80	-65	-45	-22
1870	4	32	53	66	78	86	88	86	77	62
1880	45	27	8	-12	-32	-50	-66	-81	-94	-102
1890	-105	-106	-102	-92	-81	-67	-48	-24	4	37
1900	68	96	124	141	142	129	105	81	55	30
1910	9	-6	-20	-35	-48	-55	-68	-69	-66	-66
1920	-62	-61	-59	-58	-54	-48	-41	-31	-22	-16
1930	-14	-12	-10	-12	-12	-13	-13	-9	-5	0
1940	6	13	22	28	35	44	49	50	47	37
1950	27	16	6	0	-4	-9	-16	-24	-31	-36
1960	-37	-33	-23	-11	2	17	32	45	54	59
1970	58	52	41	28	14	1	-10	-22	-36	-47
1980	-58	-70	-80	-91	-100	-104	-104	-101	-94	-84
1990	-71	-55	-35	-10	14	31	44	52	51	41
2000	29	14	-3	-14	-17	-15	-7	5	20	34
2010	52	70	84	91	91	82	64	44	22	4
2020	-19	-30	-40	-50	-61	-72	-82	-91	-96	-94
2030	-86	-75	-62	-49	-34	-15	0	11	17	22
2040	26	29	32	32	28	20	8	-5	-19	-37
2050	-53	-63	-71	-78	-82	-86	-89	-89	-88	-87
2060	-85	-80	-68	-50	-27	-6	14	31	43	53
2070	62	75	92	108	122	132	136	131	121	114
2080	108	104	100	86	61	38	22	9	2	0
2090	-2	-4	-8	-11	-17	-22	-26	-32	-42	-56
2100	-70	-85	-98	-108	-115	-119	-121	-122	-122	-117

TO BE CONTINUED

CONTINUED (S-2106 NORTH)

NO.	(1)	(2)	(3)	(4)	(5)	(6)	(7)	(8)	(9)	(10)	
2110	-110	-101	-91	-80	-70	-62	-49	109	-29	-7	13
2120	31	51	69	81	89	97	105	110	105	105	105
2130	90	73	51	34	22	15	6	0	-5	-12	-12
2140	-16	-18	-18	-18	-15	-13	-7	-2	2	9	9
2150	18	28	38	48	56	59	58	54	44	29	29
2160	7	-18	-66	-75	-99	-116	-127	-130	-126	-118	-118
2170	-107	-93	-78	-63	-48	-34	-23	-15	-7	0	0
2180	8	16	25	33	40	45	48	45	41	41	41
2190	40	39	38	35	33	29	22	15	8	5	5
2200	-4	-9	-14	-18	-18	-16	-9	-2	5	14	14
2210	22	29	35	46	57	71	84	95	103	106	106
2220	102	95	90	86	78	65	48	27	3	-16	-16
2230	-30	-37	-40	-37	-34	-35	-38	-41	-44	-44	-44
2240	-42	-39	-35	-34	-34	-38	-45	-54	-60	-64	-64
2250	-68	-70	-70	-68	-66	-68	-73	-78	-80	-80	-80
2260	-79	-74	-69	-62	-53	-42	-30	-15	2	21	21
2270	36	49	58	61	59	54	46	37	27	18	18
2280	10	6	2	5	12	20	25	27	29	30	30
2290	30	31	30	28	24	23	18	14	9	3	3
2300	-1	-6	-13	-19	-24	-27	-28	-29	-27	-24	-24
2310	-17	-19	-18	-14	-14	-12	-11	-9	-5	-1	-1
2320	-21	-16	-15	-14	13	16	18	20	21	24	24
2330	1	6	10	13	16	18	32	28	22	14	14
2340	28	33	37	38	39	36	32	28	22	14	14
2350	7	-1	-7	-13	-17	-18	-15	-13	-10	-7	-7
2360	-5	1	6	11	17	23	30	34	40	45	45
2370	50	53	50	50	44	35	26	17	6	-1	-1
2380	-8	-16	-25	-35	-45	-55	-67	-81	-95	-111	-111
2390	-72	-70	-67	-59	-48	-32	-17	-3	9	20	20
2400	27	32	33	34	34	34	36	40	46	48	48
2410	47	44	38	34	31	30	29	29	29	28	28
2420	27	27	29	30	31	31	30	30	30	31	31
2430	30	28	23	17	11	6	0	-5	-11	-16	-16
2440	-18	-20	-19	-16	-13	-8	0	8	15	22	22
2450	31	39	46	52	59	66	74	79	79	71	71
2460	58	42	23	2	-20	-40	-57	-68	-77	-84	-84
2470	-89	-90	-92	-94	-94	-93	-91	-89	-87	-84	-84
2480	-78	-73	-68	-59	-49	-35	-23	-13	-6	-1	-1
2490	1	4	6	7	7	9	10	13	14	16	16
2500	19	21	22	22	21	21	24	28	34	44	44
2510	41	49	55	58	59	57	55	52	48	44	44
2520	39	33	27	19	11	4	-2	-7	-10	-12	-12
2530	-14	-16	-16	-15	-16	-17	-17	-17	-16	-16	-16
2540	-12	-10	-9	-7	-8	-14	-21	-29	-36	-45	-45
2550	-53	-55	-55	-53	-48	-43	-36	-27	-19	-11	-11
2560	-5	-1	3	8	13	20	27	35	41	46	46
2570	49	51	53	55	56	55	50	44	37	30	30
2580	23	15	9	4	0	-2	-2	-3	-3	-3	-3
2590	-4	-7	-11	-11	-8	-3	12	19	25	33	33
2600	30	31	30	28	24	18	13	10	9	9	9
2610	6	6	4	2	0	-1	-3	-3	-5	-11	-11
2620	-18	-25	-34	-42	-47	-51	-53	-53	-53	-50	-50
2630	-45	-40	-33	-25	-19	-15	-11	-7	-4	-1	-1
2640	0	-1	-2	-5	-6	-7	-9	-10	-9	-8	-8

TO BE CONTINUED

CONTINUED (S-2106 NORTH)

NO.	(1)	(2)	(3)	(4)	(5)	(6)	(7)	(8)	(9)	(10)	
2650	-8	-7	-6	-3	-1	2	9	16	22	25	25
2660	25	32	42	46	47	45	40	33	24	13	13
2670	-25	-34	-42	-46	-47	-45	-40	-33	-24	-13	-13
2680	-4	4	11	19	24	28	31	32	32	31	31
2690	29	25	22	20	17	13	11	5	-2	-12	-12
2700	-21	-28	-36	-41	-46	-51	-53	-53	-51	-50	-50
2710	58	64	69	74	80	86	91	96	101	106	106
2720	-10	-10	-10	-9	-10	-12	-13	-12	-8	-5	-5
2730	-2	0	0	0	3	4	6	6	5	4	4
2740	3	1	0	0	0	0	-1	-4	-3	-1	-1
2750	2	2	2	2	5	7	8	12	18	22	22
2760	25	27	29	30	31	32	35	35	34	33	33
2770	32	32	32	29	22	17	11	6	0	-2	-2
2780	-5	-7	-10	-10	-10	-8	-4	0	0	5	5
2790	12	12	12	11	11	12	13	14	13	10	10
2800	6	2	-2	-4	-4	-3	-2	-1	0	2	2
2810	4	5	6	9	14	19	22	25	28	29	29
2820	30	29	25	24	21	20	17	15	12	10	10
2830	10	10	10	11	12	15	17	19	18	16	16
2840	16	16	16	15	15	16	15	14	12	9	9
2850	6	5	1	-1	-4	-8	-12	-16	-21	-28	-28
2860	-38	-47	-55	-63	-69	-76	-82	-86	-87	-84	-84
2870	-78	-72	-64	-55	-44	-35	-29	-24	-19	-16	-16
2880	-15	-13	-14	-13	-11	-9	-9	-8	-7	-7	-7
2890	-7	-6	-4	-2	3	10	16	24	27	30	30
2900	31	32	34	35	35	34	33	32	32	31	31
2910	30	28	25	23	19	13	7	0	-8	-15	-15
2920	-1	-8	-16	-23	-31	-40	-50	-62	-73	-85	-85
2930	-74	-72	-69	-62	-58	-55	-52	-48	-42	-35	-35
2940	-26	-15	-5	3	11	18	22	25	29	32	32
2950	35	37	38	41	44	46	45	44	41	38	38
2960	34	31	29	24	20	15	7	0	-4	-8	-8
2970	13	-16	-21	-25	-30	-35	-41	-46	-48	-49	-49
2980	-48	-45	-42	-38	-33	-30	-28	-30	-32	-31	-31
2990	-50	-50	-50	-50	-50	-50	-50	-50	-50	-50	-50
3000	27	38	49	59	68	73	77	80	83	84	84
3010	86	87	91	87	80	72	64	57	51	45	45
3020	40	36	30	21	11	0	-10	-19	-29	-38	-38
3030	16	4	-3	-7	-10	-10	-10	-10	-9	-8	-8
3040	-23	-20	-17	-13	-9	-6	-4	-4	-4	-4	-4
3050	-45	-43	-42	-42	-41	-39	-35	-31	-27	-24	-24
3060	-19	-13	-7	-3	0	6	10	13	16	20	20
3070	23	26	31	36	41	45	47	48	47	46	46
3080	46	47	46	44	42	40	36	33	29	26	26
3090	24	21	18	16	14	12	10	8	4	2	2
3100	-1	-6	-11	-15	-20	-24	-29	-34	-38	-43	-43
3110	-68	-68	-68	-68	-68	-68	-68	-68	-68	-68	-68
3120	-54	-54	-54	-54	-54	-54	-54	-54	-54	-54	-54
3130	38	41	43	45	45	45	45	45	45	45	45
3140	43	45	47	53	58	61	66	72	76	77	77
3150	75	73	71	67	60	52	44	33	23	14	14
3160	6	0	-2	-3	-5	-6	-6	-6	-5	-4	-4
3170	-4	-4	-4	-4	-4	-4	-4	-4	-4	-4	-4
3180	-14	-15	-15	-15	-15	-15	-15	-15	-15	-15	-15

TO BE CONTINUED

CONTINUED (S-2106 NORTH)

CONTINUED (S-2106 NORTH)

NO.	(1)	(2)	(3)	(4)	(5)	(6)	(7)	(8)	(9)	(10)
3190	-12	-14	-17	-19	-23	-27	-31	-33	-36	-38
3200	-40	-42	-44	-44	-44	-42	-42	-42	-41	-42
3210	-42	-41	-41	-41	-40	-39	-37	-33	-27	-23
3220	-20	-15	-10	-6	0	20	7	13	16	21
3230	21	19	17	19	22	26	29	30	34	38
3240	39	42	45	48	49	49	49	48	48	45
3250	43	40	37	35	31	25	18	10	4	2
3260	2	2	2	2	2	2	2	2	2	2
3270	-4	-6	-9	-13	-17	-20	-24	-26	-26	-24
3280	-6	-5	-3	-3	-16	-13	-12	-9	-7	-6
3290	17	17	17	17	17	17	19	24	26	31
3300	34	35	38	39	41	44	45	45	44	46
3310	49	49	46	45	43	43	43	45	46	47
3320	48	49	49	45	40	36	30	25	20	14
3330	8	1	-3	-8	-12	-16	-19	-23	-26	-27
3340	-27	-26	-26	-26	-26	-28	-29	-30	-32	-36
3350	-40	-42	-43	-44	-46	-47	-47	-47	-47	-47
3360	-47	-46	-46	-46	-45	-43	-42	-41	-39	-39
3370	-29	-29	-26	-25	-23	-20	-14	-9	-4	0
3380	3	4	7	11	15	17	22	28	32	35
3390	38	41	43	43	42	39	36	34	32	30
3400	27	24	22	20	17	13	9	3	-1	-4
3410	-4	-7	-9	-11	-12	-11	-10	-10	-10	-10
3420	-11	-12	-12	-10	-8	-7	-7	-9	-11	-12
3430	-15	-15	-15	-16	-17	-19	-20	-20	-20	-19
3450	-15	-11	-7	-3	1	5	11	14	17	24
3460	30	34	39	44	47	50	52	51	50	49
3470	47	42	38	34	31	27	20	16	13	10
3480	10	12	15	17	21	24	27	33	39	41
3490	43	45	45	45	45	43	39	34	29	23
3500	16	9	4	1	-1	-4	-6	-6	-6	-5
3510	-4	-1	-1	0	3	5	7	7	4	0
3520	-2	-4	-5	-8	-12	-17	-24	-28	-32	-37
3530	-41	-44	-46	-46	-47	-47	-47	-46	-46	-44
3540	-40	-36	-31	-28	-25	-20	-14	-7	-1	4
3550	8	12	13	16	19	22	23	24	25	24
3560	30	32	28	26	25	26	26	25	24	24
3570	22	21	20	18	17	15	10	7	4	0
3580	-3	-7	-11	-11	-11	-12	-15	-15	-16	-21
3590	-24	-26	-29	-30	-29	-23	-18	-13	-9	-4
3600	3	7	10	14	20	25	29	31	33	32
3610	31	30	29	27	26	23	19	15	12	9
3620	5	2	2	0	-2	-6	-10	-15	-18	-22
3630	-24	-26	-27	-27	-24	-19	-14	-9	-7	4
3640	12	19	25	32	41	48	55	57	65	70
3650	71	74	79	82	84	87	87	87	87	87
3660	86	84	81	79	74	68	60	51	43	35
3670	29	22	17	13	11	7	3	1	-1	-3
3680	-5	-4	-3	-6	-9	-10	-7	-4	-2	0
3690	3	7	10	12	14	16	17	19	19	19
3700	18	18	17	16	15	15	16	17	15	15
3710	14	15	12	12	12	8	5	1	0	-1
3720	-4	-7	-11	-19	-22	-27	-30	-34	-35	-35

TO BE CONTINUED

TO BE CONTINUED

CONTINUED(S-2106 NORTH)

NO.	(1)	(2)	(3)	(4)	(5)	(6)	(7)	(8)	(9)	(10)
4270	5	3	2	0	-1	-1	0	-1	0	2
4280	0	0	2	3	3	7	8	0	6	5
4290	5	7	6	4	3	2	1	0	-1	2
4300	-3	-6	-9	-10	-12	-22	-25	-25	-30	-30
4310	-32	-34	-35	-38	-38	-36	-36	-36	-36	-35
4320	-32	-32	-28	-24	-24	-22	-21	-20	-19	-19
4330	-20	-19	-17	-15	-15	-20	-21	-19	-19	-19
4340	-19	-16	-15	-15	-15	-11	-7	-8	-10	-10
4350	-10	-7	-5	-5	-5	-9	-7	-9	-10	-10
4360	-11	-11	-12	-10	-9	-9	-8	-6	-6	-6
4370	-6	-2	-3	-2	-3	-3	-1	0	0	0
4380	2	4	4	5	-5	-6	-6	-7	-10	-10
4390	0	-1	-3	-5	-5	-5	0	3	4	4
4400	-13	-13	-11	-9	-14	-15	18	19	19	19
4410	6	13	12	14	17	27	31	28	25	25
4420	20	22	24	27	27	30	31	28	25	25
4430	21	20	17	15	12	9	10	10	10	10
4440	10	10	10	9	9	8	10	10	9	8
4450	8	9	10	12	16	16	16	12	10	11
4460	12	8	5	5	4	3	3	3	2	2
4470	1	0	0	-2	-2	-2	-5	-5	-5	-5
4480	-9	-12	-12	-14	-14	-12	-11	-14	-18	-18
4490	-20	-21	-23	-25	-26	-24	-24	-28	-30	-30
4500	-30	-28	-26	-25	-25	-22	-19	-16	-13	-13
4510	-12	-12	-10	-6	-4	-2	0	0	1	2
4520	3	3	2	1	0	0	0	0	0	0
4530	0	0	0	1	2	1	0	2	5	6
4540	8	10	12	13	12	15	11	10	9	9
4550	8	5	4	1	-3	-8	-11	-16	-18	-19
4560	-20	-19	-20	-21	-21	-20	-21	-18	-16	-16
4570	-13	-9	-6	-7	-7	-3	0	-1	-2	-2
4580	-2	-2	-2	-2	-2	-1	0	0	0	0
4590	-2	-6	-7	-5	-6	-6	-6	-5	-4	-3
4600	-2	-2	-2	-1	1	4	7	10	10	11
4610	13	12	13	13	14	15	17	17	18	18
4620	20	22	19	18	17	17	19	16	14	14
4630	11	13	16	15	13	13	13	13	12	12
4640	11	9	6	4	2	2	1	0	0	0
4650	-2	-4	-4	-2	-2	-6	-6	-7	-9	-11
4660	-13	-16	-18	-19	-18	-17	-18	-19	-18	-18
4670	-16	-14	-14	-14	-11	-7	-4	0	6	10
4680	11	12	14	19	23	23	24	23	22	22
4690	20	19	18	18	19	18	17	17	17	17
4700	16	14	13	10	14	12	12	13	12	12
4710	12	11	10	9	7	4	4	3	2	0
4720	-2	-3	-1	-1	-2	-2	-1	0	1	1
4730	0	0	1	2	3	4	4	3	2	0
4740	1	2	0	1	2	0	-2	-2	-2	-1
4750	-1	0	0	1	3	5	8	10	13	15
4760	17	19	20	20	22	24	24	22	19	17
4770	16	15	12	9	6	3	0	-3	-5	-6
4780	-8	-10	-11	-12	-15	-16	-16	-18	-19	-19
4790	-20	-22	-21	-21	-19	-17	-16	-15	-16	-16
4800	-17	-18	-19	-19	-19	-18	-17	-15	-10	-10

TO BE CONTINUED

TO BE CONTINUED

RECORD = S-2106 COMPONENT = EAST STATION = KOKEN-S
 DATE AND TIME = 1987-12-17-11-08 TOTAL NUMBER OF DATA = 5850
 SAMPLING INTERVAL = 0.010 (SEC) SIGNAL = GR. ACC.
 CONNECTION POINT IN DATA NUMBER = 3008, 5850,

NO.	(1)	(2)	(3)	(4)	(5)	(6)	(7)	(8)	(9)	(10)
5350	0	0	-1	-2	-2	-4	-7	-9	-12	-12
5360	-12	-12	-12	-13	-13	-15	-16	-16	-15	-14
5370	-14	-13	-11	-11	-12	-12	-12	-12	-12	-10
5380	-9	-6	-5	-5	-6	-8	-8	-5	-6	-7
5390	-7	-6	-4	-2	-1	-3	-4	-3	0	0
5400	0	1	2	3	7	10	10	9	10	11
5410	12	14	16	17	18	20	20	21	22	22
5420	20	18	17	17	16	14	13	14	14	14
5430	11	7	7	6	2	1	0	-1	-1	-2
5440	-7	-13	-16	-20	-32	-24	-26	-27	-29	-32
5450	-35	-34	-36	-36	-36	-37	-35	-34	-35	-35
5460	-36	-31	-28	-25	-25	-22	-22	-20	-19	-18
5470	-18	-17	-17	-17	-17	-17	-18	-19	-18	-19
5480	-17	-19	-20	-20	-20	-19	-17	-17	-17	-18
5490	-19	-18	-18	-17	-15	-15	-14	-12	-9	-9
5500	-9	-9	-6	-3	-1	-1	0	0	0	1
5510	0	-1	-1	-2	0	2	0	0	0	2
5520	0	4	3	4	4	4	3	4	4	7
5530	8	6	4	6	8	8	10	12	11	13
5540	13	13	12	12	11	10	11	12	11	10
5550	10	10	10	10	8	7	8	6	6	7
5560	6	4	3	2	2	3	3	1	0	1
5570	2	0	0	0	0	1	2	2	2	2
5580	3	4	5	9	8	8	8	8	12	14
5590	15	17	17	19	20	22	24	25	24	23
5600	22	22	22	21	20	19	19	17	15	12
5610	9	7	4	2	2	2	2	3	3	2
5620	2	3	5	6	6	9	12	14	15	17
5630	19	20	20	19	19	20	19	20	19	20
5640	18	17	17	17	16	13	13	13	12	12
5650	8	5	4	3	3	3	3	4	5	4
5660	3	1	-1	-3	-4	-4	-4	-4	-5	-6
5670	-7	-8	-7	-6	-6	-5	-5	-7	-7	-7
5680	-3	-2	-1	-1	-1	0	0	0	0	3
5690	5	5	5	5	6	5	6	7	7	6
5700	5	5	7	9	10	10	10	11	12	11
5710	9	11	16	17	17	17	18	17	15	14
5720	15	17	15	14	12	10	12	10	7	5
5730	4	1	0	0	-3	-6	-7	-8	-9	-11
5740	-7	-5	-8	-12	-16	-18	-17	-16	-17	-14
5750	-20	-20	-20	-21	-19	-18	-17	-16	-14	-14
5760	-13	-12	-9	-6	-4	-4	-4	-4	-3	-2
5770	0	0	0	0	1	2	2	2	3	4
5780	6	7	8	8	8	8	10	11	12	13
5790	13	10	7	5	5	4	5	3	1	0
5800	0	-3	-4	-4	-5	-3	-1	-1	-1	0
5810	-1	-2	-2	-2	-3	-4	-7	-7	-4	-4
5820	-6	-9	-10	-10	-12	-12	-12	-13	-14	-14
5830	-16	-17	-19	-19	-21	-21	-23	-23	-22	-21
5840	-22	-24	-24	-24	-24	-24	-24	-23	-21	-20

END

NO.	(1)	(2)	(3)	(4)	(5)	(6)	(7)	(8)	(9)	(10)
0	19	19	19	19	18	17	16	15	14	13
10	12	11	10	9	7	6	5	5	5	2
20	1	3	4	6	8	10	12	14	16	16
30	17	17	17	17	15	14	12	10	9	8
40	8	8	8	8	8	9	10	11	13	13
50	12	9	6	1	-3	-8	-11	-14	-13	-11
60	-7	-2	2	5	7	9	9	8	8	9
70	10	11	11	10	11	12	14	15	14	14
80	12	11	11	11	10	11	12	14	15	14
90	37	34	28	21	14	11	11	12	13	12
100	9	4	0	-2	-2	-1	0	0	-1	-1
110	-1	0	0	0	-1	-5	-9	-13	-15	-15
120	-16	-14	-13	-12	-9	-3	6	15	22	22
130	28	34	35	33	32	31	29	26	25	24
140	25	25	20	18	17	13	8	0	-7	-14
150	-20	-22	-21	-16	-9	0	9	19	27	-27
160	22	13	3	-2	-3	-1	1	4	4	0
170	-2	-1	2	8	16	22	25	26	25	25
180	27	30	33	34	32	28	16	11	7	1
190	-4	-5	-2	0	8	13	15	13	9	5
200	3	1	0	0	1	4	9	18	28	34
210	40	41	37	30	23	20	17	15	16	13
220	9	3	0	0	3	8	15	17	13	7
230	2	1	3	8	13	15	13	8	6	7
240	11	13	13	11	8	6	8	14	19	20
250	19	16	15	15	21	25	25	18	9	0
260	0	5	15	23	27	24	15	6	0	-3
270	2	9	15	16	14	6	-3	-10	-15	-12
280	-3	5	13	19	21	19	16	14	14	16
290	18	20	21	17	12	10	11	14	18	17
300	13	8	-2	0	-1	-1	-2	-3	-4	-5
310	-6	-7	-6	-2	2	6	11	14	17	20
320	21	19	19	15	12	8	10	12	15	17
330	19	20	20	20	18	13	8	6	5	9
340	12	14	13	9	4	0	-5	-8	-9	-11
350	-11	-7	-3	8	12	16	19	21	24	24
360	-28	-20	-29	-26	-23	-19	-17	-18	-20	-19
370	17	15	12	11	12	13	12	11	9	9
380	9	9	7	4	0	-2	-3	-5	-4	-1
390	2	3	4	2	-2	-8	-10	-5	3	12
400	18	19	17	10	5	4	10	19	28	32
410	34	29	21	15	10	14	16	16	16	16
420	13	8	2	0	3	5	4	0	-3	0
430	-5	-4	-2	0	0	0	0	1	6	12
440	15	16	15	10	5	1	0	-3	-13	-20
450	-26	-30	-35	-15	-10	-17	-20	-19	19	19
460	22	30	38	45	46	42	36	31	26	24
470	23	20	11	-12	-13	-21	-24	-24	-23	-24
480	-29	-30	-31	-25	-12	-2	3	4	5	5

TO BE CONTINUED

CONTINUED(S-2106 EAST)

NO.	(1)	(2)	(3)	(4)	(5)	(6)	(7)	(8)	(9)	(10)
490	7	16	30	38	38	30	15	0	-11	-17
500	-19	-17	-13	9	-2	7	16	23	-25	24
510	20	14	-7	-1	-3	-5	-5	-10	-15	-20
520	-22	-23	-22	-19	-14	-5	6	20	29	29
530	31	29	22	13	9	10	12	18	21	20
540	18	19	21	22	12	3	-4	-9	-9	-9
550	-10	-9	-9	-9	-9	-9	-9	-9	-9	-9
560	-2	-2	-12	-18	-20	-21	-20	-18	-18	-21
570	22	20	12	25	12	25	54	35	34	35
580	33	30	27	24	18	9	0	-9	-13	-25
590	-30	-29	-22	-11	11	22	29	32	33	33
600	34	31	24	18	14	13	13	9	3	3
610	-3	-8	-12	-9	-1	21	24	26	28	28
620	28	28	30	31	30	23	10	-6	-9	-9
630	-10	-8	-12	-21	-33	-45	-51	-8	-38	-23
640	-7	2	9	13	17	23	50	35	38	34
650	23	9	-1	-8	-9	-6	-5	-4	-4	-3
660	-1	2	6	7	3	-3	-10	-14	-13	-7
670	0	6	9	7	5	2	1	-5	-6	-8
680	-9	-9	-9	-5	0	1	0	0	-3	-3
690	0	1	2	0	-2	-5	-1	6	16	23
700	22	14	0	-14	-22	-25	-20	-8	3	8
710	11	13	15	20	26	29	50	29	25	18
720	13	8	6	4	2	0	-4	-9	-14	-15
730	-16	-17	-16	-13	-9	-5	-3	-4	-7	-12
740	-20	-22	-17	-5	2	4	0	-8	-17	-19
750	-13	-1	12	21	24	19	9	3	5	12
760	23	32	37	39	42	50	60	67	69	66
770	58	43	26	11	-8	-20	-34	-45	-51	-51
780	-53	-47	-36	-28	-27	-32	-37	-40	-36	-24
790	-6	8	14	10	-3	-18	-28	-33	-32	-30
800	-30	-31	-32	-32	-26	-16	3	9	10	10
810	11	13	19	24	25	23	15	4	-6	-13
820	-14	-13	-8	0	5	9	11	13	13	11
830	7	1	-4	-6	-5	-2	2	4	7	7
840	3	0	-5	-11	-15	-19	-19	-21	-24	-26
850	-26	-26	-26	-23	-14	-3	6	18	33	46
860	54	56	52	45	31	15	2	-5	-11	-14
870	-14	-9	-3	0	1	2	3	0	-4	-10
880	-16	-21	-22	-23	-23	-23	-23	-24	-28	-34
890	-37	-41	-45	-45	-45	-61	-60	-59	-53	-64
900	-76	-85	-96	-97	-94	-88	-80	-72	-70	-71
910	-76	-81	-93	-96	-96	-96	-92	-87	-78	-66
920	-53	-39	-21	-1	10	14	14	14	15	15
930	16	20	21	22	23	25	26	29	35	45
940	55	59	58	51	43	37	28	16	5	-5
950	-18	-29	-39	-44	-46	-49	-50	-51	-53	-56
960	-62	-70	-78	-83	-87	-90	-93	-92	-87	-78
970	-66	-48	-28	-11	2	7	5	-1	-14	-25
980	-26	-15	16	67	123	175	233	309	376	420
990	447	457	460	460	459	455	452	448	437	404
1000	348	285	205	101	-18	-145	-261	-370	-485	-567
1010	-605	-619	-614	-591	-554	-514	-480	-443	-426	-396
1020	-362	-324	-281	-239	-194	-156	-134	-122	-113	-105

TO BE CONTINUED

CONTINUED(S-2106 EAST)

NO.	(1)	(2)	(3)	(4)	(5)	(6)	(7)	(8)	(9)	(10)
1030	-93	-72	-25	62	153	256	373	483	580	653
1040	688	702	699	677	626	534	439	334	282	129
1050	36	73	73	83	101	115	111	76	-1	-105
1060	-200	-262	-292	-297	-280	-254	-229	-213	-210	-221
1070	-247	-285	-317	-339	-360	-372	-372	-356	-325	-276
1080	-195	-92	14	106	180	216	228	238	199	131
1090	64	2	-50	-70	-81	8	110	158	257	285
1100	290	285	277	274	286	310	338	352	348	297
1110	235	165	97	52	15	-24	-69	-130	-200	-265
1120	-305	-319	-319	-312	-304	-302	-306	-315	-325	-333
1130	-338	-342	-350	-359	-362	-350	-305	-223	-108	35
1140	165	246	289	296	274	232	180	125	77	33
1150	-5	-30	-39	-36	-21	2	22	39	54	68
1160	84	112	155	202	269	309	328	331	305	238
1170	143	44	-18	-46	-52	-47	-59	-37	-50	-84
1180	-118	-133	-141	-147	-158	-183	-225	-274	-316	-353
1190	-310	-239	-140	-37	40	72	77	72	61	49
1200	43	44	49	56	63	75	100	137	176	212
1210	234	241	221	176	125	81	50	36	36	53
1220	78	108	137	161	175	178	173	156	120	61
1230	-17	-92	-150	-195	-232	-252	-257	-240	-200	-138
1240	-64	31	97	124	129	122	108	98	99	109
1250	127	146	154	142	110	65	11	-50	-96	-127
1260	-149	-164	-170	-167	-156	-139	-119	-103	-95	-82
1270	-91	-91	-88	-81	-69	-50	-21	8	40	77
1280	121	164	200	232	257	271	275	270	254	206
1290	136	73	36	18	11	8	2	-21	-76	-148
1300	-204	-238	-252	-257	-259	-259	-255	-247	-232	-206
1310	-165	-99	-67	-59	-61	-71	-88	-94	-83	-56
1320	-12	23	37	35	20	-1	-18	-23	-17	-4
1330	9	28	54	86	118	149	169	170	150	113
1340	60	10	-33	-74	-116	-163	-199	-216	-220	-212
1350	-181	-135	-78	-17	36	80	130	183	242	287
1360	312	319	305	268	215	163	114	74	64	16
1370	-20	-60	-91	-110	-119	-118	-106	-90	-62	-29
1380	5	26	47	68	81	94	111	126	138	143
1390	144	140	126	104	84	64	48	41	36	33
1400	28	23	19	16	13	11	10	8	2	-7
1410	-70	-26	30	-26	-17	-11	-10	-15	-23	-51
1420	-70	-78	-78	-70	-59	-47	-37	-28	-23	-19
1430	-15	-11	-5	0	3	3	0	6	18	32
1440	-45	-56	-59	-54	-34	11	76	118	151	165
1450	163	147	111	82	64	57	50	42	30	4
1460	-24	-42	-44	-42	0	35	64	88	101	102
1470	93	75	42	-15	-79	-123	-147	-157	-148	-124
1480	-36	-52	-14	10	28	43	55	61	60	52
1490	36	15	-6	-25	-43	-64	-90	-124	-161	-198
1500	-219	-226	-218	-201	-175	-143	-119	-97	-78	-56
1510	-29	-1	26	6	45	41	31	21	17	15
1520	14	11	7	0	-12	-23	-30	-32	-27	-13
1530	2	16	31	47	61	71	80	86	93	103
1540	115	130	143	154	159	158	149	131	109	82
1550	50	25	5	-17	-40	-66	-95	-120	-138	-148
1560	-150	-147	-139	-142	-149	-149	-150	-149	-146	-144

TO BE CONTINUED

CONTINUED(S-2106 EAST)

CONTINUED(S-2106 EAST)

NO.	(1)	(2)	(3)	(4)	(5)	(6)	(7)	(8)	(9)	(10)
1570	-141	-135	-124	-107	-80	-45	-14	9	27	41
1580	48	56	66	78	90	98	101	100	95	92
1590	85	76	61	36	8	-17	-33	-39	-40	-33
1600	-23	-15	7	1	11	27	47	64	74	76
1610	73	66	58	49	42	55	27	18	6	-7
1620	-24	-42	-59	-75	-88	-96	-97	-92	-80	-64
1630	-44	-26	-13	-5	3	12	20	28	36	43
1640	45	45	45	47	54	71	96	125	141	145
1650	137	117	94	79	71	66	64	59	50	35
1660	24	16	11	12	14	13	7	-4	-16	-30
1670	-39	-44	-47	-69	-51	-51	-51	-50	-48	-48
1680	-51	-60	-72	-86	-98	-101	-98	-89	-74	-56
1690	-36	-14	7	28	45	52	51	44	33	19
1700	5	-5	-10	-13	-13	-10	-4	3	15	28
1710	41	52	61	65	63	61	54	46	38	30
1720	23	16	8	3	0	8	-2	-12	-19	-29
1730	70	72	65	45	23	8	-2	19	29	44
1740	-45	-61	-71	-72	-70	-65	-56	-50	-46	-46
1750	-50	-54	-57	-54	-42	-30	-19	-11	-8	-7
1760	-9	-11	-11	-11	-10	-7	-6	-5	-4	-4
1770	0	3	5	7	16	26	35	43	49	54
1780	56	53	46	38	28	10	-15	-43	-70	-88
1790	-94	-90	-80	-62	-44	-31	-21	-11	-7	2
1800	7	13	17	16	12	7	6	4	7	16
1810	26	32	34	31	16	-8	-35	-63	-83	-95
1820	-101	-102	-95	-85	-75	-66	-56	-42	-20	6
1830	35	61	79	91	96	94	89	82	75	66
1840	57	48	36	22	12	8	14	30	51	66
1850	73	74	68	56	45	38	34	29	24	16
1860	6	-5	-10	-9	-4	2	5	0	-16	-46
1870	-73	-90	-95	-95	-91	-85	-79	-75	-69	-60
1880	-49	-38	-27	-19	-11	-5	0	3	8	15
1890	23	29	29	25	16	0	-19	-38	-54	-64
1900	-70	-71	-69	-63	-52	-40	-33	-31	-31	-32
1910	-34	-35	-36	-34	-28	-22	-16	-10	-6	-1
1920	8	20	32	37	35	27	14	0	-16	-33
1930	-48	-63	-72	-79	-83	-81	-78	-75	-71	-70
1940	-70	-70	-68	-66	-61	-54	-44	-30	-11	4
1950	20	33	40	44	44	44	35	32	28	24
1960	20	16	13	13	22	36	54	73	87	97
1970	102	99	87	73	62	53	43	30	12	-5
1980	-16	-21	-19	-16	-9	-3	0	-2	-2	-2
1990	-3	0	2	4	5	3	0	-4	-4	-4
2000	-2	3	8	7	6	4	1	-2	0	0
2010	7	19	29	35	39	40	41	42	41	38
2020	37	35	30	14	-12	-39	-57	-68	-76	-77
2030	-76	-74	-74	-80	-88	-94	-96	-95	-89	-79
2040	-65	-54	-44	-34	-23	-11	14	27	36	44
2050	43	51	62	70	74	78	78	76	73	68
2060	65	63	55	44	26	3	-18	-35	-41	-36
2070	-26	-14	3	6	15	27	40	53	62	62
2080	57	47	34	24	19	17	15	10	1	-11
2090	-26	-36	-39	-36	-29	-24	-22	-23	-24	-25
2100	-18	-13	-9	-4	0	1	0	0	2	7

TO BE CONTINUED

TO BE CONTINUED

CONTINUED(S-2106 EAST)

NO.	(1)	(2)	(3)	(4)	(5)	(6)	(7)	(8)	(9)	(10)
2650	-37	-33	-27	-21	-14	-7	0	3	7	10
2660	9	6	2	-1	-4	-5	-6	-10	-17	-23
2670	-27	-30	-31	-32	-32	-30	-27	-21	-14	0
2680	13	25	36	45	50	54	58	60	58	58
2690	56	52	48	44	38	33	26	16	6	0
2700	-6	-8	-9	-7	-6	-5	-5	-8	-15	-23
2710	-30	-35	-37	-38	-38	-36	-33	-33	-29	-29
2720	-25	-20	-15	-9	-3	2	5	7	10	12
2730	14	17	14	20	20	18	15	12	8	2
2740	-5	-14	-24	-34	-41	-46	-51	-57	-63	-70
2750	-81	-87	-91	-93	-91	-87	-83	-78	-74	-70
2760	-79	-76	-73	-67	-64	-61	-56	-48	-38	-23
2770	-8	7	22	32	37	41	44	48	53	59
2780	65	66	69	72	75	80	84	86	88	90
2790	92	93	96	99	101	101	98	89	79	69
2800	59	48	39	33	28	22	15	7	0	-5
2810	-10	-16	-23	-29	-34	-40	-42	-43	-42	-39
2820	-39	-39	-40	-44	-51	-58	-64	-68	-70	-74
2830	-78	-82	-85	-85	-85	-82	-78	-70	-61	-51
2840	-45	-38	-33	-30	-28	-28	-29	-27	-26	-26
2850	-25	-20	-16	-10	-2	8	21	32	41	48
2860	55	59	60	58	53	46	39	34	50	26
2870	21	18	17	15	17	20	25	30	35	44
2880	38	38	35	32	27	22	18	13	9	4
2890	0	-4	-11	-16	-21	-24	-26	-26	-26	-26
2900	-20	-28	-24	-23	-21	-18	-15	-14	-13	-13
2910	-12	-11	-11	-8	-2	2	6	8	11	13
2920	15	15	14	14	13	12	11	10	6	1
2930	-2	-2	0	5	11	14	14	13	13	12
2940	14	19	23	27	29	31	33	36	40	47
2950	53	57	59	61	61	62	64	65	66	68
2960	66	60	54	47	42	40	37	36	35	32
2970	28	25	21	18	15	12	11	10	7	3
2980	-1	-5	-9	-13	-19	-24	-30	-37	-44	-52
2990	-60	-66	-70	-73	-75	-75	-75	-76	-76	-73
3000	-70	-68	-64	-60	-57	-52	-49	-49	-47	-39
3010	-25	-18	-8	2	9	15	22	28	31	33
3020	36	40	42	44	45	43	40	36	32	29
3030	26	21	18	13	7	1	-3	-6	-6	-6
3040	5	-5	-3	-1	0	-2	-2	-1	-17	-26
3050	-36	-44	-50	-55	-61	-66	-69	-71	-70	-68
3060	-66	-63	-58	-52	-48	-43	-36	-28	-23	-15
3070	-18	-14	-10	-5	-2	0	4	7	9	12
3080	15	16	18	18	19	20	21	21	23	24
3090	29	31	35	38	38	40	42	44	48	53
3100	59	62	64	67	71	70	69	66	63	60
3110	56	51	46	43	39	36	28	21	14	9
3120	4	1	-2	-6	-8	-9	-10	-12	-12	-12
3130	-10	-7	-8	-10	-12	-13	-13	-13	-10	-8
3140	0	6	12	16	20	23	25	23	21	19
3150	18	16	12	11	11	11	11	11	11	11
3160	18	16	12	11	11	11	11	11	11	11
3170	-5	-6	-9	-10	-13	-16	-20	-21	-21	-20
3180	-21	-22	-19	-17	-14	-12	-9	-6	-2	0

TO BE CONTINUED

TO BE CONTINUED

CONTINUED< S-2106 EAST)

CONTINUED< S-2106 EAST)

NO.	(1)	(2)	(3)	(4)	(5)	(6)	(7)	(8)	(9)	(10)
3730	-16	-18	-20	-20	-19	-20	-21	-20	-19	-18
3740	-18	-17	-17	-16	-13	-10	-10	-10	-9	-8
3750	-8	-8	-7	-7	-6	-7	-7	-8	-9	-10
3760	-11	-12	-13	-14	-16	-17	-16	-17	-18	-18
3770	-18	-18	-17	-18	-18	-17	-16	-17	-15	-14
3780	-12	-11	-10	-7	-6	-4	-2	0	3	3
3790	4	6	8	9	12	15	18	21	24	29
3800	32	35	37	37	39	41	40	35	30	30
3810	24	21	17	9	2	-5	-10	-14	-20	-26
3820	-31	-34	-38	-41	-43	-42	-40	-39	-40	-39
3830	-37	-35	-36	-35	-32	-29	-28	-28	-27	-23
3840	-21	-20	-18	-16	-14	-11	-8	-5	0	1
3850	4	6	9	9	7	7	8	12	15	18
3860	18	18	19	22	26	27	27	28	31	30
3870	28	23	25	21	19	17	15	14	11	7
3880	3	0	-3	-5	-7	-11	-14	-17	-20	-22
3890	-23	-23	-22	-22	-23	-23	-22	-20	-20	-20
3900	-19	-18	-16	-16	-16	-16	-16	-16	-16	-15
3910	-15	-16	-16	-16	-17	-16	-15	-13	-10	-6
3920	-3	0	0	3	5	9	10	14	19	22
3930	26	26	25	24	24	24	24	24	24	23
3940	24	27	31	32	29	27	27	26	26	26
3950	21	18	16	13	11	8	6	4	2	0
3960	0	1	1	2	2	2	2	2	0	0
3970	16	18	19	20	21	22	24	25	26	26
3980	26	24	20	16	9	2	-5	-14	-20	-24
3990	-27	-30	-31	-33	-35	-37	-42	-46	-47	-44
4000	-50	-52	-51	-52	-53	-52	-49	-47	-44	-41
4010	-37	-34	-29	-23	-17	-9	-3	4	10	15
4020	19	22	27	31	36	42	48	53	57	60
4030	63	64	64	64	64	64	61	57	53	49
4040	45	36	28	21	18	11	5	-6	-15	-25
4050	-31	-38	-45	-48	-51	-54	-57	-61	-63	-63
4060	-62	-61	-60	-57	-53	-53	-52	-51	-48	-46
4070	-42	-40	-38	-37	-35	-33	-32	-29	-25	-21
4080	-18	-15	-13	-12	-12	-12	-12	-12	-12	-11
4090	-9	-8	-7	-6	-3	2	8	13	17	21
4100	24	27	31	34	34	34	35	36	36	35
4110	35	32	31	30	29	28	27	26	26	26
4120	25	22	21	19	17	14	11	9	8	6
4130	6	7	7	7	9	9	9	11	12	14
4140	16	16	15	14	15	13	12	10	7	3
4150	0	-3	-5	-8	-10	-13	-15	-15	-16	-16
4160	-17	-16	-13	-10	-10	-9	-7	-4	-1	0
4170	0	0	-2	-2	-3	-3	-2	-2	-3	-6
4180	-9	-12	-13	-13	-13	-13	-13	-13	-14	-16
4190	-16	-17	-16	-16	-15	-14	-13	-12	-11	-11
4200	-12	-12	-12	-12	-10	-8	-6	-3	-1	1
4210	-1	0	1	1	4	7	9	11	11	11
4220	11	11	13	15	16	15	14	12	8	4
4230	0	-3	-7	-12	-18	-21	-25	-27	-30	-32
4240	-35	-35	-32	-32	-31	-27	-24	-21	-17	-10
4250	-5	-1	1	4	4	12	18	23	27	32
4260	36	40	45	49	51	55	58	59	60	61

TO BE CONTINUED

TO BE CONTINUED

CONTINUED(S-2106 EAST)

CONTINUED(S-2106 EAST)

NO.	(1)	(2)	(3)	(4)	(5)	(6)	(7)	(8)	(9)	(10)	(11)	(12)	(13)	(14)	(15)	(16)	(17)	(18)	(19)	(20)	
4810	25	28	28	28	28	28	29	27	26	24		8	8	8	8	8	8	8	8	8	8
4820	21	19	17	17	18	17	15	13	9	8		4	3	3	4	4	4	4	4	4	4
4830	8	9	9	9	7	6	6	5	4	3		4	4	4	4	4	4	4	4	4	4
4840	2	1	0	-3	-5	-8	-9	-10	-10	-11		11	11	10	9	8	7	6	5	4	3
4850	-13	-17	-20	-21	-20	-20	-21	-22	-23	-23		4	4	4	4	4	4	4	4	4	4
4860	-23	-22	-19	-18	-18	-18	-16	-12	-7	-4		-4	-4	-4	-4	-4	-4	-4	-4	-4	-4
4870	-1	3	4	6	6	9	9	8	7	6		-4	-4	-4	-4	-4	-4	-4	-4	-4	-4
4880	7	8	7	5	2	0	0	-1	-2	-3		-4	-4	-4	-4	-4	-4	-4	-4	-4	-4
4890	-6	-10	-12	-14	-19	-22	-27	-31	-36	-40		3	3	3	3	3	3	3	3	3	3
4900	-43	-45	-49	-52	-54	-55	-55	-54	-51	-48		3	3	3	3	3	3	3	3	3	3
4910	-48	-45	-41	-37	-31	-26	-21	-15	-12	-12		3	3	3	3	3	3	3	3	3	3
4920	-9	-6	-4	-1	0	4	9	12	17	21		15	15	16	16	16	16	16	16	16	16
4930	22	24	25	26	26	27	28	28	27	26		17	17	17	17	17	17	17	17	17	17
4940	24	21	20	20	21	23	22	20	19	19		18	18	18	18	18	18	18	18	18	18
4950	19	18	17	16	14	12	9	8	6	6		10	10	10	10	10	10	10	10	10	10
4960	6	7	7	7	7	7	8	8	7	7		10	10	10	10	10	10	10	10	10	10
4970	8	8	8	9	9	7	8	6	5	3		17	17	19	19	19	19	19	19	19	19
4980	3	2	0	-1	-3	-5	-6	-6	-8	-10		14	14	14	14	14	14	14	14	14	14
4990	-13	-15	-17	-18	-18	-19	-21	-22	-23	-23		4	4	4	4	4	4	4	4	4	4
5000	-22	-21	-21	-20	-20	-17	-15	-13	-11	-10		4	4	4	4	4	4	4	4	4	4
5010	-9	-7	-5	-4	-2	0	0	3	4	5		10	10	10	10	10	10	10	10	10	10
5020	7	9	10	13	14	14	14	14	14	13		10	11	11	11	11	11	11	11	11	11
5030	12	12	10	9	7	7	7	7	8	7		11	11	11	11	11	11	11	11	11	11
5040	7	7	8	7	6	5	3	3	0	-1		14	14	16	16	16	16	16	16	16	16
5050	-2	3	-4	-7	-8	-7	-6	-7	-7	-7		13	13	13	13	13	13	13	13	13	13
5060	-7	-7	-7	-7	-7	-7	-6	-6	-5	-3		10	10	10	10	10	10	10	10	10	10
5070	-2	0	0	1	2	5	6	7	8	9		12	12	12	12	12	12	12	12	12	12
5080	8	8	9	10	11	11	12	14	15	17		16	16	16	16	16	16	16	16	16	16
5090	17	16	16	17	18	19	18	16	14	14		16	16	16	16	16	16	16	16	16	16
5100	12	12	11	11	11	11	11	11	11	11		16	16	16	16	16	16	16	16	16	16
5110	13	13	14	14	14	14	14	14	14	14		16	16	16	16	16	16	16	16	16	16
5120	2	-1	-4	-7	-9	-12	-16	-20	-22	-23		14	14	14	14	14	14	14	14	14	14
5130	-35	-28	-30	-30	-30	-30	-32	-32	-33	-33		14	14	14	14	14	14	14	14	14	14
5140	-33	-32	-33	-32	-29	-26	-23	-21	-21	-20		14	14	14	14	14	14	14	14	14	14
5150	-18	-14	-11	-7	-5	-4	-1	0	3	4		14	14	14	14	14	14	14	14	14	14
5160	5	8	9	12	14	17	17	17	16	16		14	14	14	14	14	14	14	14	14	14
5170	17	17	17	18	19	18	16	16	16	14		14	14	14	14	14	14	14	14	14	14
5180	12	12	11	11	11	12	13	10	8	7		14	14	14	14	14	14	14	14	14	14
5190	4	1	1	1	0	0	-1	-3	-5	-6		14	14	14	14	14	14	14	14	14	14
5200	-4	-3	-1	0	1	1	1	1	2	4		14	14	14	14	14	14	14	14	14	14
5210	6	9	12	13	12	11	11	12	13	15		14	14	14	14	14	14	14	14	14	14
5220	16	14	11	10	8	5	3	1	1	1		14	14	14	14	14	14	14	14	14	14
5230	0	-3	-6	-8	-8	-12	-15	-15	-14	-11		14	14	14	14	14	14	14	14	14	14
5240	-15	-17	-18	-20	-20	-24	-25	-23	-21	-21		14	14	14	14	14	14	14	14	14	14
5250	-21	-20	-18	-16	-14	-12	-10	-10	-9	-7		14	14	14	14	14	14	14	14	14	14
5260	-3	0	1	0	4	4	4	4	4	4		14	14	14	14	14	14	14	14	14	14
5270	11	8	7	7	5	4	4	3	0	-2		14	14	14	14	14	14	14	14	14	14
5280	-4	-5	-4	-5	-8	-8	-7	-7	-8	-8		14	14	14	14	14	14	14	14	14	14
5290	-7	-6	-7	-8	-7	-6	-6	-6	-9	-11		14	14	14	14	14	14	14	14	14	14
5300	-15	-16	-16	-16	-17	-20	-21	-21	-21	-21		14	14	14	14	14	14	14	14	14	14
5310	-21	-22	-23	-22	-22	-22	-22	-22	-22	-21		14	14	14	14	14	14	14	14	14	14
5320	-18	-18	-18	-18	-15	-14	-14	-13	-12	-12		14	14	14	14	14	14	14	14	14	14
5330	-13	-13	-13	-13	-13	-13	-13	-13	-13	-13		14	14	14	14	14	14	14	14	14	14
5340	-3	-4	-6	-5	-5	-5	-4	-4	-4	-4		14	14	14	14	14	14	14	14	14	14

TO BE CONTINUED

END

RECORD = S-2106 COMPONENT = DOWN STATION = KOKEN-S
 DATE AND TIME = 1987-12-17-11-08 TOTAL NUMBER OF DATA = 5850
 SAMPLING INTERVAL = 0.010 (SEC) SCAL = 0.10000
 SIGNAL = GR. ACC.
 CONNECTION POINT IN DATA NUMBER = 3010, 5850,

NO.	(1)	(2)	(3)	(4)	(5)	(6)	(7)	(8)	(9)	(10)
0	11	11	11	11	11	11	11	10	10	9
10	9	8	7	6	4	3	1	0	-1	-2
20	-1	0	0	3	6	10	14	18	21	23
30	24	22	17	12	5	-1	-8	-14	-17	-15
40	-11	-3	5	19	32	44	55	62	69	67
50	65	48	30	2	-25	-52	-75	-95	-102	-106
60	-104	-102	-98	-91	-83	-75	-68	-61	-50	-41
70	-30	-18	-6	5	13	18	21	22	22	22
80	21	19	17	14	12	10	11	11	18	28
90	39	49	57	62	65	63	59	52	41	29
100	17	4	-3	-6	-5	-3	0	1	3	3
110	1	-5	-16	-32	-54	-73	-84	-91	-89	-83
120	-71	-54	-31	-8	9	19	21	15	5	4
130	-13	-18	-18	-16	-14	-9	0	16	32	48
140	65	82	95	96	77	53	29	8	-7	-19
150	-29	-35	-35	-29	-16	5	29	48	61	66
160	64	57	46	33	24	22	27	33	39	44
170	47	48	44	36	25	17	14	15	18	23
180	30	38	42	42	36	28	17	-1	-41	-40
190	-36	-26	-10	11	12	8	0	-13	-25	-25
200	-37	-38	-31	-19	-6	2	7	18	36	58
210	83	99	104	95	80	61	45	37	33	32
220	32	32	34	35	36	39	40	38	34	25
230	15	7	-1	-7	-10	-10	-7	-3	0	1
240	0	-2	-9	-18	-27	-29	-24	-16	-7	-1
250	5	16	27	36	43	46	44	41	36	31
260	24	12	4	-1	-4	-7	-6	-1	2	5
270	7	9	12	13	15	15	13	12	12	12
280	11	12	16	23	29	30	27	23	22	22
290	22	21	19	16	8	-2	-11	-17	-20	-22
300	20	-18	-15	-10	-5	0	3	7	8	6
310	-70	-69	-65	-62	-55	-43	-31	-18	22	49
320	70	69	65	55	35	10	-11	-26	-32	-32
330	-30	-27	-25	-23	-22	-14	0	14	26	33
340	32	25	15	6	2	6	11	12	11	7
350	4	2	1	0	0	0	16	21	26	32
360	35	38	43	47	48	45	42	32	21	10
370	1	-5	-8	-9	-9	-9	-10	-11	-12	-14
380	-16	-16	-13	-11	-7	-1	5	10	15	20
390	25	28	30	31	28	22	16	11	7	6
400	5	1	-8	-20	-34	-46	-48	-37	-18	0
410	15	27	33	35	36	38	38	40	46	51
420	56	59	61	64	66	69	71	69	63	53
430	41	29	18	9	-4	-9	-14	-18	-21	-21
440	-22	-25	-29	-34	-37	-42	-49	-55	-60	-62
450	-61	-53	-33	-15	1	13	19	21	24	30
460	36	48	64	79	86	85	79	71	64	55
470	41	26	14	6	0	-2	0	0	0	0
480	-1	1	6	10	11	12	11	7	1	-7

TO BE CONTINUED

	(1)	(2)	(3)	(4)	(5)	(6)	(7)	(8)	(9)	(10)
1030	18	35	47	54	57	57	50	36	12	-21
1040	-55	-89	-120	-147	-159	-163	-158	-148	-134	-116
1050	-95	-74	-52	-34	-21	-10	0	10	15	13
1060	8	2	-4	-7	-5	3	22	54	93	135
1070	179	219	244	253	247	226	181	116	52	-4
1080	-55	-92	-110	-117	-118	-115	-112	-106	-101	-100
1090	-102	-105	-110	-117	-128	-139	-149	-155	-156	-156
1100	-133	-114	-93	-71	-54	-43	-30	-13	7	29
1110	52	72	87	97	101	101	98	95	94	96
1120	100	105	110	115	121	125	125	125	123	123
1130	117	107	92	74	50	21	-4	-32	-35	-42
1140	47	-52	-58	-71	-86	-101	-118	-132	-141	-145
1150	-144	-140	-135	-113	-87	-66	-49	-29	0	27
1160	54	80	98	105	107	104	96	85	75	65
1170	58	57	58	62	71	79	85	87	88	88
1180	85	80	71	61	50	38	27	11	-4	-19
1190	-30	-38	-45	-52	-56	-57	-55	-51	-47	-44
1200	-41	-39	-38	-38	-38	-38	-38	-39	-40	-39
1210	-39	-39	-39	-39	-38	-39	-40	-41	-39	-34
1220	-19	6	36	63	84	100	111	116	118	114
1230	106	97	84	50	57	44	32	17	4	-10
1240	-25	-37	-50	-57	-58	-54	-48	-42	-38	-31
1250	-24	-14	-3	6	14	22	27	30	32	33
1260	32	32	32	34	36	36	38	38	39	39
1270	37	33	26	17	10	8	8	10	16	23
1280	29	36	44	50	54	57	57	55	47	35
1290	17	-5	-26	-51	-75	-97	-110	-116	-115	-106
1300	-96	-83	-72	-63	-60	-45	-57	-56	-52	-46
1310	-36	-23	-7	26	45	64	78	83	81	81
1320	76	67	58	48	41	37	35	31	27	22
1330	16	11	8	7	8	7	6	0	-6	-13
1340	-19	-25	-31	-39	-51	-64	-78	-91	-99	-103
1350	-104	-99	-99	-72	-52	-30	-11	4	18	30
1360	40	47	53	57	59	60	55	48	42	38
1370	37	44	53	64	70	71	65	52	35	12
1380	-5	-16	-26	-31	-33	-36	-36	-34	-30	-28
1390	-25	-23	-23	-24	-23	-20	-15	-9	-3	0
1400	0	3	5	7	5	4	2	0	-6	-13
1410	-19	-26	-31	-33	-32	-32	-32	-31	-28	-28
1420	-26	-24	-23	-25	-25	-25	-27	-26	-22	-18
1430	-12	-6	-1	3	4	5	4	1	0	0
1440	-1	-2	-3	-3	0	2	6	13	22	32
1450	44	58	67	71	67	57	40	19	-1	-16
1460	-27	-32	-33	-32	-32	-29	-23	-12	1	13
1470	20	26	28	25	19	9	0	-6	-12	-16
1480	-16	-16	-14	-8	0	5	10	15	12	9
1490	2	-6	-19	-29	-34	-36	-33	-27	-17	-7
1500	2	12	20	27	34	39	45	51	58	62
1510	64	67	68	71	73	71	66	58	48	37
1520	24	10	-3	-15	-27	-40	-50	-57	-59	-59
1530	-58	-54	-46	-34	-20	-6	6	17	25	30
1540	32	34	34	33	34	35	36	38	38	37
1550	35	30	23	16	11	10	9	5	1	1
1560	-5	-9	-12	-16	-18	-19	-19	-22	-27	-30

TO BE CONTINUED

TO BE CONTINUED

CONTINUED(S-2106 DOWN)

NO.	(1)	(2)	(3)	(4)	(5)	(6)	(7)	(8)	(9)	(10)
2110	-5	-4	-3	-2	0	1	0	-2	-6	-10
2120	-13	-16	-17	-18	-15	-9	-5	-2	0	1
2130	3	6	4	2	2	-1	-3	-4	-6	-6
2140	-6	-4	-4	-3	-2	0	0	2	0	2
2150	-1	-4	-6	-5	-5	-6	-5	-2	0	2
2160	3	3	4	5	6	5	6	8	7	6
2170	6	5	5	5	6	0	0	-1	-1	0
2180	2	5	7	12	16	18	17	18	13	14
2190	13	11	9	17	16	18	10	13	13	15
2200	16	17	15	13	12	10	11	12	12	13
2210	16	18	17	17	17	13	7	-4	-10	-10
2220	-15	-17	-17	-15	-14	-14	-14	-14	-14	-11
2230	-9	-6	-1	4	7	9	14	18	18	18
2240	18	16	12	7	2	-2	-9	-16	-23	-30
2250	-36	-41	-44	-47	-50	-50	-48	-47	-44	-40
2260	-36	-33	-31	-32	-34	-33	-33	-31	-28	-25
2270	-20	-17	-12	-8	-4	0	3	8	13	17
2280	21	21	21	24	27	29	28	26	27	28
2290	30	31	34	36	36	37	37	37	37	35
2300	33	28	22	15	8	0	-8	-14	-19	-23
2310	-28	-32	-34	-36	-36	-34	-32	-28	-23	-20
2320	-19	-18	-17	-15	-14	-13	-11	-8	-5	-2
2330	0	1	2	2	1	0	-1	-2	-3	-6
2340	-7	-7	-7	-8	-7	-7	-5	1	6	10
2350	12	13	15	19	21	25	27	29	31	32
2360	31	32	30	27	25	24	23	21	19	16
2370	14	11	8	-2	-11	-21	-30	-45	-62	-82
2380	-46	-49	-49	-51	-53	-53	-50	-47	-45	-42
2390	-39	-36	-30	-26	-20	-15	-12	-10	-8	-6
2400	-5	-5	-7	-7	-8	-10	-14	-18	-21	-21
2410	-18	-17	-16	-13	-8	-4	-3	-2	1	5
2420	7	11	15	18	21	21	21	21	21	23
2430	25	28	31	34	37	42	46	51	54	56
2440	58	60	60	59	57	52	45	36	26	16
2450	7	2	0	-3	-3	-2	0	2	6	9
2460	10	10	12	11	9	5	2	-1	-9	-9
2470	-9	-9	-7	-6	-5	-2	3	9	12	13
2480	15	13	12	10	7	6	4	1	-1	-5
2490	-8	-11	-9	-5	-3	0	4	8	10	13
2500	15	17	19	20	20	19	17	14	13	12
2510	11	10	8	9	10	10	11	10	8	8
2520	10	12	13	15	16	16	17	20	22	24
2530	26	29	30	31	34	36	34	31	31	35
2540	31	31	30	30	26	24	22	18	15	15
2550	13	11	8	6	6	0	0	-2	-5	-7
2560	-8	-7	-6	-9	-11	-13	-17	-20	-24	-28
2570	-30	-31	-34	-35	-37	-39	-41	-41	-42	-43
2580	-41	-40	-39	-37	-34	-31	-27	-21	-15	-12
2590	-9	-7	-7	-7	-8	-7	-7	-6	-5	-4
2600	-1	0	1	3	6	11	15	18	21	23
2610	22	21	19	16	11	7	4	0	-2	-6
2620	-4	-3	-3	-3	-3	-3	-3	-6	-7	-8
2630	-8	-9	-11	-10	-8	-9	-9	-9	-11	-10
2640	-9	-9	-9	-9	-9	-9	-9	-5	-4	-3

TO BE CONTINUED

CONTINUED(S-2106 DOWN)

NO.	(1)	(2)	(3)	(4)	(5)	(6)	(7)	(8)	(9)	(10)
2650	-1	0	0	1	1	3	4	5	5	5
2660	7	8	7	7	5	-11	1	0	-2	-3
2670	-3	-5	-8	-8	-10	16	-10	-7	-6	-2
2680	0	4	6	6	13	18	18	18	17	17
2690	13	9	7	3	-1	-5	-10	-12	-14	-16
2700	-20	-22	-23	-23	-23	-22	-21	-20	-19	-17
2710	-14	-10	-6	-1	1	4	8	12	17	21
2720	21	18	15	13	12	11	9	7	4	0
2730	-3	-7	-8	-11	-15	-19	-22	-24	-24	-24
2740	-24	-23	-22	-20	-16	-13	-8	-5	-3	0
2750	2	4	7	11	12	13	15	17	18	17
2760	18	20	21	18	11	8	4	0	-1	-2
2770	-4	-7	-10	-12	-14	-14	-14	-11	-8	-3
2780	0	2	4	7	9	12	14	15	17	19
2790	21	23	24	25	25	25	25	26	24	21
2800	17	14	12	8	2	-4	-8	-13	-17	-21
2810	-23	-24	-24	-22	-21	-20	-15	-11	-6	-1
2820	4	10	14	19	24	29	31	33	36	37
2830	37	36	36	36	37	36	34	31	27	24
2840	22	18	10	2	-5	-14	-23	-32	-38	-62
2850	-47	-51	-53	-53	-53	-53	-54	-54	-55	-55
2860	-54	-55	-55	-55	-55	-48	-45	-42	-38	-34
2870	-29	-25	-16	-9	-2	6	14	21	29	35
2880	40	45	50	56	61	63	63	63	61	57
2890	52	49	44	37	32	28	25	21	16	12
2900	9	7	3	0	-2	-6	-11	-17	-24	-26
2910	-27	-28	-28	-25	-23	-20	-17	-13	-9	-6
2920	-1	4	9	13	19	23	24	25	25	26
2930	27	28	28	26	24	20	15	10	4	-1
2940	-6	-12	-18	-23	-29	-36	-42	-43	-45	-48
2950	-48	-48	-48	-48	-46	-44	-40	-37	-34	-30
2960	-25	-20	-16	-11	-4	0	5	10	13	16
2970	20	22	25	27	27	29	29	28	29	30
2980	31	33	32	31	31	31	31	30	28	25
2990	22	20	19	18	16	13	10	9	8	6
3000	5	5	5	5	5	5	5	5	5	5
3010	1	0	-2	-2	-4	-7	-8	-11	-14	-19
3020	-25	-31	-38	-44	-50	-54	-55	-56	-58	-59
3030	-59	-56	-52	-52	-52	-50	-46	-42	-38	-35
3040	-31	-27	-26	-23	-19	-17	-12	-9	-7	-3
3050	-1	0	0	2	3	5	6	8	11	11
3060	9	9	9	8	7	4	4	4	5	9
3070	12	13	14	15	15	15	16	18	22	24
3080	26	27	31	36	40	44	48	51	53	53
3090	52	51	47	46	43	40	36	31	27	23
3100	19	17	14	12	7	3	0	0	-1	-4
3110	-5	-4	-4	-4	-3	-2	0	3	5	7
3120	17	18	14	15	15	15	15	15	15	16
3130	17	18	21	24	25	26	28	29	29	29
3140	28	29	30	32	32	31	30	30	30	27
3150	25	21	18	14	9	3	-4	-12	-19	-27
3160	-35	-44	-51	-58	-63	-68	-69	-70	-70	-70
3170	-67	-65	-61	-56	-51	-50	-44	-38	-33	-27
3180	-22	-17	-14	-9	-4	1	7	14	20	25

TO BE CONTINUED

NO.	(1)	(2)	(3)	(4)	(5)	(6)	(7)	(8)	(9)	(10)
3190	25	27	28	29	29	29	29	29	28	28
3200	28	27	25	25	23	23	23	23	15	12
3210	8	5	2	-1	-5	-10	-13	-13	-16	-20
3220	-23	-25	-27	-27	-28	-28	-25	-24	-20	-24
3230	-16	-11	-8	-5	-3	0	3	4	7	7
3240	9	9	10	10	11	13	13	13	13	13
3250	13	14	15	15	13	11	10	11	12	15
3260	12	12	13	15	16	19	21	23	25	25
3270	30	33	35	35	38	38	38	38	39	39
3280	39	39	40	40	40	40	39	37	36	34
3290	29	25	21	17	15	11	9	8	7	7
3300	4	2	2	2	2	2	2	2	0	0
3310	-1	-1	-4	-5	-6	-7	-7	-7	-6	-6
3320	-6	-6	-8	-10	-11	-12	-13	-14	-14	-16
3330	-16	-16	-16	-14	-12	-10	-9	-8	-6	-6
3340	-3	-1	0	0	-1	-3	-3	-4	-6	-10
3350	-13	-14	-15	-15	-13	-11	-7	-3	1	6
3360	10	14	15	16	19	21	23	22	19	19
3370	17	14	15	15	11	8	4	3	2	2
3380	2	0	-2	-4	-6	-6	-2	1	3	3
3390	5	6	7	9	10	10	8	5	4	4
3400	3	2	0	-2	-5	-6	-7	-9	-12	-15
3410	-17	-20	-23	-26	-31	-34	-35	-34	-34	-34
3420	-35	-34	-34	-34	-30	-27	-24	-23	-21	-21
3430	-18	-16	-16	-14	-12	-9	-8	-2	6	6
3440	10	14	16	21	25	29	32	34	35	34
3450	39	44	47	50	51	52	52	53	53	51
3460	47	45	42	37	35	34	33	31	30	30
3470	27	27	26	24	23	22	22	18	16	16
3480	15	15	13	9	5	0	-5	-4	-5	-5
3490	-5	-6	-6	-5	-5	-5	-5	-5	-4	-8
3500	-8	-6	-5	-4	-1	1	4	6	10	12
3510	10	8	8	8	8	7	4	0	-1	-4
3520	-6	-8	-10	-13	-14	-15	-19	-21	-20	-20
3530	-23	-24	-25	-26	-28	-30	-30	-27	-25	-25
3540	-25	-23	-21	-19	-15	-10	-4	1	3	8
3550	12	15	18	20	21	23	26	28	31	32
3560	32	35	36	37	37	37	37	37	34	34
3570	31	31	31	31	32	29	27	23	22	22
3580	20	19	19	18	17	15	15	15	14	13
3590	13	12	10	8	8	8	6	5	5	5
3600	4	4	5	6	7	9	10	8	7	7
3610	7	6	4	2	0	-2	-5	-9	-10	-13
3620	-15	-17	-17	-19	-21	-21	-20	-19	-17	-15
3630	-9	-14	-10	-6	-4	-2	1	7	8	8
3640	15	15	15	15	15	15	15	15	15	15
3650	17	17	15	17	18	20	23	25	27	31
3660	33	34	35	36	36	36	37	38	38	38
3670	38	36	35	33	30	29	27	24	21	19
3680	17	15	14	12	9	5	3	2	0	0
3690	0	0	0	0	-3	-4	-4	-3	0	0
3700	0	0	0	2	4	4	3	3	6	7
3710	5	5	2	1	0	-1	-3	-5	-6	-10
3720	-15	-16	-16	-19	-19	-20	-21	-20	-21	-20

TO BE CONTINUED

TO BE CONTINUED

CONTINUED (S-2106 DOWN)

CONTINUED (S-2106 DOWN)

NO.	(1)	(2)	(3)	(4)	(5)	(6)	(7)	(8)	(9)	(10)
4270	3	0	0	3	5	4	3	5	7	9
4280	9	11	12	11	11	12	14	11	9	11
4290	12	11	8	8	9	9	9	8	4	4
4300	0	-1	-3	-5	-7	-7	-9	-10	-12	-14
4310	-16	-19	-19	-19	-19	-19	-19	-17	-15	-13
4320	-10	-7	-5	-4	-2	-1	0	1	4	4
4330	5	4	4	5	6	7	8	9	11	10
4340	9	9	12	12	10	12	12	12	12	13
4350	16	17	16	14	12	13	14	11	9	8
4360	9	4	4	0	0	-2	-4	-5	-6	-7
4370	-8	-9	-10	-11	-11	-10	-10	-12	-12	-12
4380	-12	-13	-14	-15	-15	-13	-12	-10	-8	-7
4390	-7	-7	-5	-4	-2	0	4	6	9	9
4400	10	12	14	15	18	20	23	23	25	24
4410	23	24	27	23	20	18	17	17	15	14
4420	11	5	10	9	5	4	4	6	6	3
4430	0	0	0	-1	0	-2	-5	-5	-5	-4
4440	-4	-4	-4	-4	-4	-4	-4	-2	0	-1
4450	0	-1	0	-1	0	-2	-2	-2	-1	0
4460	0	1	3	0	0	0	0	3	1	0
4470	-2	-2	0	0	-2	-2	-1	-1	0	0
4480	-3	5	0	-1	0	0	-1	0	1	2
4490	5	0	0	-1	0	0	-2	-4	-7	-8
4500	-23	-22	-22	-19	-16	-14	-14	-13	-11	-8
4510	-2	-6	-6	-5	-1	0	0	-1	0	0
4520	2	5	6	7	8	9	9	11	12	14
4530	0	15	16	17	18	20	22	24	25	25
4540	15	16	16	17	18	20	22	24	26	28
4550	27	28	30	30	30	31	29	27	26	25
4560	23	22	21	18	15	14	13	14	13	14
4570	12	10	8	8	7	6	5	5	4	4
4580	2	0	-1	0	0	-1	-2	-5	-8	-9
4590	-10	-11	-14	-15	-16	-17	-17	-19	-21	-20
4600	-21	-20	-21	-20	-20	-18	-16	-14	-13	-12
4610	-10	-8	-5	-3	0	4	5	5	7	10
4620	10	10	10	13	14	13	14	13	13	17
4630	16	15	16	16	19	18	15	14	14	14
4640	11	9	10	9	7	7	9	13	14	12
4650	11	12	12	11	10	9	7	3	1	0
4660	-1	-1	-1	-2	-2	-2	-4	-7	-8	-10
4670	-10	-11	-10	-9	-10	-9	-9	-9	-8	-6
4680	-6	-6	-6	-6	-6	-7	-7	-7	-9	-9
4690	-7	-7	-9	-11	-12	-14	-14	-14	-15	-15
4700	-15	-13	-13	-14	-17	-19	-19	-18	-17	-18
4710	-19	-19	-19	-18	-17	-17	-17	-17	-18	-18
4720	-17	-18	-18	-17	-17	-18	-18	-19	-19	-18
4730	-3	-2	0	2	4	6	8	12	15	16
4740	19	20	21	22	22	22	22	22	25	24
4750	23	22	22	22	23	25	28	28	28	28
4760	20	19	17	17	16	15	15	15	14	14
4770	14	13	12	12	14	15	12	9	9	11
4780	12	11	9	7	7	7	7	6	5	4
4790	5	5	6	7	7	7	7	10	12	14
4800	14	12	11	10	7	7	6	4	1	-1

TO BE CONTINUED

TO BE CONTINUED

NO.	(1)	(2)	(3)	(4)	(5)	(6)	(7)	(8)	(9)	(10)
5350	9	8	8	8	8	7	7	7	7	7
5360	8	7	6	6	3	2	2	2	-1	-1
5370	-2	-4	-5	-6	-6	-6	-6	-6	-10	-14
5380	-15	-14	-14	-16	-16	-13	-13	-12	-12	-12
5390	-10	-10	-10	-11	-11	-9	-7	-7	-7	-7
5400	-7	-7	-5	-7	-8	-7	-6	-7	-7	-8
5410	-11	-11	-12	-13	-14	-13	-12	-11	-10	-11
5420	-11	-11	-12	-13	-14	-13	-11	-13	-15	-16
5430	-15	-16	-17	-17	-17	-17	-17	-16	-16	-15
5440	-14	-14	-15	-15	-14	-12	-11	-11	-10	-10
5450	-9	-9	-9	-9	-8	-9	-11	-11	-12	-12
5460	-11	-10	-9	-9	-8	-5	-5	-5	-6	-6
5470	-4	-3	-4	-5	-4	-3	-1	-2	-2	-2
5480	-3	-5	-8	-9	-9	-9	-10	-10	-11	-11
5490	-13	-12	-10	-9	-9	-9	-8	-5	-4	-4
5500	-4	-2	-2	0	0	0	0	3	4	5
5510	8	9	12	15	15	14	14	15	15	15
5520	15	15	16	17	18	17	17	17	17	16
5530	15	15	15	16	18	17	15	12	12	11
5540	8	6	5	3	1	0	0	0	0	0
5550	0	-1	-2	-2	0	0	4	4	3	3
5560	4	5	6	7	7	8	7	7	7	6
5570	4	4	3	3	3	2	1	0	0	0
5580	0	0	0	-1	-2	-2	-2	0	-1	-2
5590	-1	-3	-4	-4	-4	-3	-3	-5	-9	-9
5600	-9	-9	-11	-13	-14	-14	-13	-12	-13	-12
5610	-10	-11	-13	-13	-13	-12	-12	-14	-14	-14
5620	-14	-16	-16	-13	-12	-10	-9	-9	-7	-6
5630	-3	-2	-2	-1	0	2	4	4	4	2
5640	4	5	5	6	7	7	7	8	6	7
5650	7	8	7	7	7	7	7	8	7	7
5660	6	7	7	9	8	7	7	8	7	7
5670	1	2	2	1	0	-1	-2	-3	-4	-3
5680	-3	-6	-7	-6	-5	-7	-10	-11	-11	-10
5690	-9	-9	-9	-9	-8	-7	-5	-6	-6	-6
5700	-4	-4	-4	-4	-5	-6	-6	-6	-6	-6
5710	-6	-8	-10	-11	-10	-11	-11	-11	-11	-12
5720	-12	-11	-12	-12	-15	-15	-14	-12	-14	-13
5730	-14	-13	-12	-11	-11	-10	-9	-9	-6	-3
5740	-2	-4	-3	-1	0	0	0	0	0	1
5750	2	3	2	2	3	3	3	4	5	7
5760	9	9	10	12	12	11	10	10	10	11
5770	12	12	13	14	14	14	14	15	16	19
5780	16	15	15	15	15	17	17	15	15	14
5790	14	15	15	15	14	14	14	14	14	14
5800	11	10	10	10	10	9	7	6	5	4
5810	4	4	3	3	3	4	2	0	0	0
5820	-1	-2	-4	-4	-4	-6	-6	-7	-10	-11
5830	-11	-11	-12	-13	-14	-14	-14	-13	-11	-12
5840	-13	-15	-12	-12	-12	-11	-11	-9	-9	-8

END

RECORD = S-2107 COMPONENT = SOUTH STATION = CHILBA--S
 DATE AND TIME = 1988-12-17-11-08 TOTAL NUMBER OF DATA = 6000
 SAMPLING INTERVAL = 0.010 (SEC) SCAL = 0.10000
 SIGNAL = GR. ACC.
 CONNECTION POINT IN DATA NUMBER = 2917, 5879, 6000,

CONTINUED (S-2107 SOUTH)

NO.	(1)	(2)	(3)	(4)	(5)	(6)	(7)	(8)	(9)	(10)
0	-136	-94	-52	-10	30	72	114	156	163	154
10	146	137	128	97	21	-53	-129	-196	-237	-278
20	346	-292	-267	-243	-191	-76	38	151	203	256
30	208	73	-61	-214	-386	-494	-578	-608	-612	-448
40	-284	-120	42	448	460	423	342	201	61	-162
50	-375	-465	-427	-356	-167	217	414	456	363	269
60	115	-43	-461	-532	-614	-580	-431	-281	341	341
70	480	393	300	168	-32	-340	-437	-468	-425	-359
80	-167	-38	370	250	155	104	-68	-249	-368	-380
90	-302	-214	-69	174	176	161	105	-24	-308	-386
100	-478	-393	-296	-180	21	211	276	237	149	54
110	-82	-216	-286	-217	-86	55	180	258	191	110
120	4	-161	-328	-353	-298	-218	-86	106	202	201
130	169	62	-72	-205	-261	-241	-140	25	161	276
140	286	258	213	116	-8	-146	-182	-208	-189	-136
150	-75	-29	-2	-4	-26	-50	-77	-90	-68	-7
160	83	150	188	146	65	-4	140	-267	-282	-258
170	-206	-106	3	30	26	-6	-58	-154	-248	-254
180	-197	-103	-39	-28	23	-21	-12	0	14	32
190	123	115	78	2	-72	-126	-160	-154	-107	-61
200	4	18	4	-36	-97	-164	-216	-181	-16	200
210	299	321	276	198	35	-108	-162	-142	-17	97
220	227	272	217	118	-80	-283	-362	-415	-362	-319
230	-217	-74	95	172	202	171	92	18	-56	-130
240	-229	-268	-260	-176	-19	109	211	245	213	150
250	-26	-127	-182	-205	-182	-163	-115	-53	-23	-39
260	-57	-96	-105	-60	37	133	204	236	240	231
270	209	169	53	-69	-182	-222	-245	-180	-51	71
280	215	296	289	267	150	-39	-170	-234	-235	-235
290	-209	-193	-194	-175	-95	140	326	425	461	427
300	277	123	-336	-529	-643	-739	-747	-509	-271	89
310	250	307	255	76	-3	-175	-208	-235	-198	-125
320	55	-37	2	1	0	-13	1	13	28	54
330	89	119	152	120	26	-102	-238	-304	-323	-288
340	-180	11	150	234	212	138	40	-29	-79	-88
350	-60	-43	-54	-83	-107	-142	-169	-169	-134	-229
360	131	274	294	254	201	107	-42	-227	405	-478
370	-482	-404	-290	-83	119	210	189	147	95	-8
380	-76	-121	-104	-67	-34	62	154	259	329	362
390	339	284	138	-50	-222	-325	-416	-407	-321	-209
400	-69	-11	-37	-81	-119	-176	-87	61	372	449
410	445	368	222	9	-183	-235	-277	-219	-123	-23
420	29	-11	-76	-113	-143	-116	-44	2	29	13
430	-30	-81	-122	-98	-17	83	167	229	268	256
440	207	148	102	68	56	56	56	51	44	35
450	29	14	-24	-67	-119	-172	-240	-259	-234	-74
460	52	170	206	178	15	-71	-137	-228	-289	-130
470	4	173	273	268	198	0	-96	-163	-246	-289
480	-225	-136	-83	-67	-87	-120	-114	-122	-87	25

TO BE CONTINUED

TO BE CONTINUED

CONTINUED (S-2107 SOUTH)

CONTINUED (S-2107 SOUTH)

NO.	(1)	(2)	(3)	(4)	(5)	(6)	(7)	(8)	(9)	(10)
1030	443	471	428	294	106	-117	-313	-606	-680	-684
1040	-387	-275	-144	9	119	138	91	5	-75	-161
1050	-290	-397	-443	-463	-398	-290	-171	-74	2	49
1060	38	-5	-78	-90	-57	-21	19	53	76	49
1070	-46	-168	-295	-369	-442	-390	-229	103	601	586
1080	705	727	706	597	475	356	273	230	202	164
1090	116	110	77	39	15	-2	-25	-53	-83	-107
1100	-157	-228	-253	-263	-243	-178	-41	209	357	387
1110	377	306	155	-58	-259	-380	-457	-338	-165	26
1120	225	354	362	281	187	70	-89	-256	-380	-446
1130	-482	-431	-387	-335	-268	-179	-68	334	180	180
1140	190	156	39	-77	-197	-291	-229	-58	358	444
1150	568	703	707	646	535	407	273	83	-4	-74
1160	-77	4	16	83	137	177	196	163	109	10
1170	-188	-331	-419	-486	-492	-455	-380	-296	-240	-215
1180	-196	-172	-142	-119	-100	-83	-22	121	207	215
1190	187	95	-53	-232	-383	-428	-450	-443	-395	-306
1200	-212	-95	29	165	272	303	276	242	191	139
1210	80	11	4	48	122	186	220	244	247	222
1220	171	121	75	26	-23	-81	-136	-239	-268	-290
1230	-273	-206	-26	61	105	162	56	-49	-143	-240
1240	-364	-344	-273	-111	176	429	510	509	465	395
1250	277	129	79	74	106	145	190	241	287	327
1260	356	397	487	502	508	479	622	318	130	-99
1270	-266	-388	-461	-369	-187	72	293	409	516	499
1280	426	345	204	109	80	79	78	58	4	-82
1290	-201	-383	-498	-580	-596	-563	-501	-427	-359	-326
1300	-326	-315	-314	-285	-209	-113	-36	17	22	-45
1310	-100	-164	-230	-284	-285	-152	48	212	236	213
1320	158	86	-68	-156	-243	-270	-237	-159	-49	90
1330	267	311	324	301	238	235	227	212	199	190
1340	189	191	191	190	178	163	158	94	38	-34
1350	-125	-229	-303	-350	-354	-347	-302	-230	-147	-84
1360	-64	-57	-44	-12	37	95	169	239	284	287
1370	240	158	83	28	-18	-24	-23	-38	-60	-116
1380	-196	-320	-393	-427	-421	-367	-293	-217	-8	181
1390	283	305	298	246	205	155	115	152	217	250
1400	297	327	327	322	326	312	268	231	214	219
1410	251	283	303	356	362	353	357	308	252	177
1420	111	54	-25	-133	-235	-284	-327	-353	-374	-393
1430	-379	-364	-349	-342	-338	-350	-371	-409	-445	-492
1440	-546	-544	-521	-502	-476	-443	-388	-281	-169	-89
1450	-22	2	-9	-54	-210	-291	-332	-357	-375	-332
1460	-232	-186	-154	-133	-157	-193	-240	-266	-268	-226
1470	-169	-54	214	445	582	631	633	597	587	561
1480	539	508	498	498	501	502	506	500	481	451
1490	431	411	387	349	298	244	186	136	82	24
1500	5	-12	-24	-22	1	44	111	156	180	201
1510	212	205	181	119	37	-29	-69	-112	-135	-201
1520	-151	-164	-175	-182	-187	-188	-175	-160	-136	-127
1530	-129	-155	-212	-232	-274	-295	-325	-359	-371	-352
1540	-321	-270	-420	-471	-122	-102	-123	-145	-164	-184
1550	-220	-237	-215	-124	-89	-26	57	104	120	120
1560	153	175	199	233	269	302	326	321	301	283
1570	249	205	170	152	133	71	-1	-43	-140	-264
1580	-383	-466	-521	-360	-555	-522	-455	-335	-260	-169
1590	-67	25	99	161	199	237	251	212	166	98
1600	52	-16	-59	-39	13	54	95	135	168	151
1610	123	92	33	-57	-87	-111	-86	-55	-9	52
1620	109	169	168	157	142	130	94	75	55	34
1630	8	-21	-75	-106	-109	-94	-67	-54	-2	37
1640	81	121	160	189	213	254	289	316	332	323
1650	124	124	124	0	-81	-136	-189	-257	-303	-314
1660	-313	-304	-289	-264	-242	-226	-198	-173	-154	-136
1670	95	-85	-79	-67	-55	-32	-15	-18	-27	-38
1680	-54	-60	-60	-71	-63	-55	-63	-55	-52	53
1690	-63	-36	25	104	160	223	242	270	234	203
1700	154	100	40	22	3	5	13	14	11	11
1710	22	21	23	33	48	59	70	65	59	52
1720	49	44	47	61	79	97	102	109	112	101
1730	66	15	-66	-113	-166	-205	-218	-205	-183	-158
1740	-123	-90	-65	-36	-12	6	64	72	86	96
1750	106	118	112	105	101	94	84	77	89	93
1760	100	111	118	122	110	93	59	15	-25	-109
1770	-160	-228	-252	-250	-234	-212	-161	-76	-67	-57
1780	-54	-77	-102	-125	-146	-155	-133	-70	21	109
1790	158	220	247	252	223	178	129	69	13	-27
1800	-58	-77	-66	-43	-18	-1	15	34	53	60
1810	52	31	10	-9	-32	-42	-29	2	63	85
1820	131	214	249	244	218	181	129	78	34	11
1830	3	3	4	-2	-12	-25	-62	-72	-110	-160
1840	-210	-209	-189	-144	-107	-74	-25	21	52	60
1850	78	97	125	158	191	200	195	170	133	66
1860	22	-67	-92	-112	-114	-89	-58	-16	6	27
1870	41	33	25	14	0	-15	-15	-11	2	44
1880	98	117	137	154	169	176	168	130	74	74
1890	14	-40	-80	-120	-155	-189	-226	-265	-300	-318
1900	-303	-278	-229	-197	-171	-150	-136	-134	-143	-158
1910	-170	-180	-185	-186	-172	-153	-146	-125	-117	-111
1920	-97	-89	-77	-74	-70	-70	-76	-86	-105	-106
1930	-99	-68	-37	-21	-17	23	34	54	84	93
1940	107	112	130	135	160	179	182	173	167	177
1950	123	113	86	69	60	75	94	108	125	125
1960	116	104	94	77	61	56	56	56	56	56
1970	56	53	50	48	48	46	39	23	-6	-24
1980	-49	-86	-113	-148	-165	-161	-135	-100	-72	-31
1990	5	53	65	57	41	23	3	-26	-41	-73
2000	-77	-82	-72	-65	-58	-48	-43	-34	-16	-1
2010	13	33	70	118	191	239	261	284	299	306
2020	312	308	279	233	161	77	-9	-127	-259	-317
2030	-355	-378	-377	-359	-314	-256	-183	-137	-140	-135
2040	-127	-125	-120	-110	-70	-13	25	48	93	137
2050	167	200	223	226	215	201	162	90	3	-41
2060	-80	-110	-113	-91	-73	-61	-58	-84	-107	-134
2070	-185	-220	-254	-300	-292	-278	-250	-204	-158	-70
2080	-47	-23	2	10	33	39	30	27	39	53
2090	81	102	134	160	188	217	238	251	266	278
2100	283	273	261	241	199	184	158	145	145	127

TO BE CONTINUED

TO BE CONTINUED

CONTINUED(S-2107 SOUTH)

CONTINUED(S-2107 SOUTH)

NO.	(1)	(2)	(3)	(4)	(5)	(6)	(7)	(8)	(9)	(10)
2110	104	60	-1	-42	-75	-101	-127	-142	-155	-161
2120	-164	-166	-161	-152	-147	-137	-115	-87	-61	-34
2130	-8	18	54	77	90	82	68	47	27	13
2140	-15	-24	-11	62	104	120	130	142	140	133
2150	111	84	54	22	3	-13	-30	-50	-33	-37
2160	-63	-74	-76	-88	-88	-13	-45	-26	-13	-14
2170	-39	-65	-90	-116	-156	-196	-238	-266	-256	-239
2180	-226	-205	-186	-173	-147	-134	-117	-102	-98	-84
2190	-92	-107	-125	-159	-190	-216	-215	-195	-144	-128
2200	-65	-11	26	40	38	56	79	130	154	225
2210	276	325	338	339	353	362	369	385	388	388
2220	383	330	278	255	208	157	59	5	-69	-113
2230	-140	-143	-192	-226	-270	-292	-329	-378	-441	-441
2240	-460	-438	-382	-311	-246	-202	-146	-122	-107	-96
2250	-96	-92	-84	-81	-77	-74	-66	-54	-37	-16
2260	5	26	46	68	90	113	126	132	155	190
2270	213	231	250	267	282	300	309	324	351	307
2280	293	272	232	194	175	156	135	113	104	112
2290	118	119	99	64	28	-11	-47	-98	-132	-148
2300	-150	-150	-162	-178	-207	-223	-247	-286	-328	-328
2310	-362	-362	-331	-298	-270	-247	-217	-189	-165	-162
2320	-134	-127	-107	-128	-123	-98	-55	-54	-11	26
2330	50	77	100	113	101	93	85	88	110	127
2340	153	193	220	225	204	184	153	120	87	54
2350	51	15	4	5	8	2	-1	-15	-42	-74
2360	-108	-142	-157	-182	-206	-212	-204	-202	-198	-181
2370	-161	-147	-129	-111	-100	-84	-76	-65	-37	-24
2380	-22	-2	15	20	46	55	61	62	62	62
2390	68	65	59	49	39	25	5	-12	-33	-60
2400	-69	-63	-50	-33	-22	-5	15	11	8	17
2410	37	47	68	99	131	151	168	168	157	148
2420	135	117	79	40	25	19	9	-12	-31	-54
2430	-74	-91	-116	-141	-154	-158	-151	-147	-143	-138
2440	-129	-119	-109	-105	-86	-63	-31	1	24	44
2450	67	79	90	93	93	101	98	91	62	49
2460	32	9	-8	-21	-18	-11	0	62	49	4
2470	0	-11	-43	-53	-58	-60	-65	-53	-43	-36
2480	-25	-5	3	8	7	6	3	-8	-18	-21
2490	-21	-20	-24	-34	-44	-50	-66	-90	-114	-130
2500	-141	-155	-174	-194	-206	-213	-207	-193	-177	-155
2510	-132	-109	-78	-27	-7	-7	-2	17	39	39
2520	68	97	115	126	127	123	105	76	53	35
2530	11	8	1	-5	0	8	14	22	32	34
2540	42	43	51	49	37	33	22	9	5	-6
2550	-7	-12	-17	-13	-16	-8	-5	-1	0	-5
2560	-6	-11	-8	-1	-2	3	1	6	0	-6
2570	-17	-26	-39	-53	-51	-44	-38	-30	-18	-18
2580	4	17	29	42	59	73	87	102	110	112
2590	106	93	76	56	33	20	23	49	75	98
2600	114	126	129	124	97	82	64	46	27	20
2610	23	27	33	28	26	18	11	0	-8	-29
2620	-55	-69	-88	-115	-141	-167	-181	-200	-216	-231
2630	-237	-238	-242	-247	-246	-241	-235	-224	-198	-170
2640	-150	-123	-101	-81	-52	-10	5	9	15	15

TO BE CONTINUED

TO BE CONTINUED

NO.	(1)	(2)	(3)	(4)	(5)	(6)	(7)	(8)	(9)	(10)
3190	-3	-7	-11	-14	-14	-10	-4	1	6	9
3200	10	10	9	8	10	12	14	15	16	18
3210	21	24	27	31	37	44	50	52	50	44
3220	35	18	-10	-36	-54	-65	-72	-77	-80	-80
3230	-79	-73	-66	-58	-49	-42	-33	-26	-22	-20
3240	-16	-11	0	15	35	56	77	93	102	110
3250	119	129	140	155	171	186	195	198	193	178
3260	153	116	83	63	49	37	25	11	-15	-24
3270	-48	-74	-99	-118	-131	-141	-149	-155	-160	-164
3280	-169	-174	-179	-181	-180	-178	-173	-169	-158	-158
3290	-150	-143	-140	-132	-120	-111	-95	-72	-53	-34
3300	9	23	50	70	93	114	128	139	143	147
3310	148	148	149	146	143	137	125	110	92	73
3320	55	37	19	12	-14	-32	-50	-66	-85	-102
3330	-115	-125	-132	-137	-139	-139	-138	-136	-135	-134
3340	-132	-129	-126	-122	-117	-110	-102	-95	-91	-88
3350	-85	-87	-90	-93	-95	-97	-97	-91	-79	-79
3360	-60	-39	-11	18	45	76	109	136	165	192
3370	209	221	229	237	242	245	249	252	256	259
3380	260	257	247	234	218	203	188	173	160	148
3390	136	121	105	85	64	41	22	5	-17	-39
3400	-64	-91	-120	-146	-169	-192	-212	-229	-242	-253
3410	-264	-274	-283	-288	-288	-284	-272	-252	-225	-192
3420	-156	-123	-91	-59	-29	7	16	21	24	24
3430	30	13	8	4	5	5	15	27	40	53
3440	67	81	96	113	134	158	181	204	224	243
3450	255	259	260	255	235	211	181	143	103	63
3460	27	-6	-34	-53	-68	-84	-96	-105	-112	-117
3470	-122	-124	-125	-126	-124	-116	-103	-87	-73	-64
3480	-56	-49	-44	-43	-45	-51	-56	-64	-75	-88
3490	-98	-106	-116	-124	-130	-134	-135	-132	-126	-118
3500	-104	-87	-71	-58	-45	-30	-17	-8	0	9
3510	16	19	17	14	8	2	-6	-17	-25	-31
3520	-36	-37	-34	-28	-21	-11	-2	7	15	21
3530	29	36	45	53	58	65	70	75	74	74
3540	74	71	70	69	66	63	60	56	55	54
3550	54	54	54	56	58	59	59	58	59	62
3560	66	72	75	79	86	91	96	99	101	101
3570	99	95	91	90	87	77	61	37	5	-16
3580	-24	-34	-46	-55	-61	-64	-68	-70	-76	-87
3590	-101	-115	-124	-131	-136	-136	-131	-117	-102	-83
3600	-63	-44	-28	-16	-8	-1	8	17	24	26
3610	28	27	25	23	20	18	15	11	6	-1
3620	-11	-23	-39	-56	-68	-74	-75	-73	-68	-62
3630	-66	-53	-53	-54	-54	-55	-57	-59	-60	-61
3640	-63	-66	-71	-78	-84	-90	-96	-102	-108	-111
3650	-112	-110	-105	-98	-88	-77	-66	-56	-43	-30
3660	-15	1	19	33	43	55	66	76	86	95
3670	55	53	52	53	53	50	47	42	36	29
3680	19	13	12	15	19	29	39	53	64	73
3690	81	88	92	98	104	108	109	105	98	89
3700	79	69	63	60	58	60	64	67	70	73
3710	75	79	85	93	102	109	117	125	130	129
3720	127	124	118	108	100	88	72	52	28	2

TO BE CONTINUED

TO BE CONTINUED

CONTINUED(S-2107 SOUTH)

Table with 15 columns: NO., (1), (2), (3), (4), (5), (6), (7), (8), (9), (10), (11), (12), (13), (14), (15), (16), (17), (18), (19), (20). Rows contain numerical data.

TO BE CONTINUED

TO BE CONTINUED

CONTINUED(S-2107 SOUTH)

NO.	(1)	(2)	(3)	(4)	(5)	(6)	(7)	(8)	(9)	(10)
5350	62	57	53	49	44	39	33	26	19	13
5360	6	0	-6	-11	-15	-17	-21	-25	-30	-34
5370	-35	-36	-40	-42	-44	-42	-41	-40	-38	-36
5380	32	29	26	22	19	16	17	16	15	15
5390	-17	-18	-19	-19	-22	-24	-27	-31	-33	-36
5400	-38	-40	-40	-40	-39	-37	-34	-32	-31	-31
5410	-30	-30	-30	-30	-31	-30	-28	-27	-25	-25
5420	-24	-23	-22	-21	-20	-20	-20	-20	-19	-19
5430	-18	-16	-15	-14	-13	-12	-12	-10	-10	-8
5440	-7	-10	-11	-14	-16	-19	-20	-22	-24	-25
5450	-28	-33	-37	-42	-47	-50	-53	-58	-61	-63
5460	-64	-68	-72	-76	-79	-82	-83	-83	-82	-80
5470	-76	-72	-69	-64	-57	-50	-42	-33	-25	-19
5480	-14	-10	-6	-1	2	4	5	8	11	16
5490	21	24	26	27	29	30	32	34	34	34
5500	37	41	45	48	53	58	61	64	65	66
5510	67	67	65	63	62	60	59	57	55	54
5520	53	52	47	42	37	30	24	19	14	9
5530	5	4	5	0	0	0	-1	-1	-1	-1
5540	-2	-1	2	4	5	6	6	5	4	5
5550	4	2	1	-1	-4	-7	-10	-12	-14	-17
5560	-20	-22	-27	-33	-38	-43	-50	-57	-63	-68
5570	-71	-75	-78	-81	-82	-83	-85	-87	-87	-87
5580	-87	-85	-85	-85	-85	-80	-77	-72	-68	-63
5590	-58	-54	-49	-45	-42	-38	-35	-28	-25	-24
5600	-21	-14	-7	1	8	15	21	21	30	39
5610	46	52	59	65	71	75	78	78	77	75
5620	75	75	75	75	75	75	75	75	75	75
5630	71	67	63	58	53	46	40	32	24	16
5640	7	-1	-10	-16	-21	-25	-30	-37	-45	-54
5650	-64	-74	-83	-90	-94	-99	-104	-108	-110	-109
5660	-111	-112	-111	-112	-112	-109	-108	-106	-105	-105
5670	-105	-105	-105	-103	-100	-96	-87	-80	-71	-62
5680	-55	-46	-34	-21	-9	4	16	27	38	45
5690	50	54	58	62	64	66	67	66	64	62
5700	58	52	45	39	32	26	23	19	15	10
5710	9	7	7	6	6	8	10	14	16	17
5720	17	18	17	15	14	14	14	15	16	17
5730	20	22	26	29	32	34	36	39	41	45
5740	47	51	53	53	53	53	52	50	48	47
5750	45	45	45	45	45	45	45	45	45	43
5760	40	39	35	32	29	25	20	16	10	4
5770	-3	-8	-12	-17	-23	-28	-33	-36	-40	-42
5780	-46	-50	-52	-53	-54	-55	-54	-53	-52	-52
5790	-53	-53	-51	-49	-47	-45	-42	-39	-36	-35
5800	-32	-30	-28	-27	-28	-28	-27	-27	-27	-29
5810	-31	-31	-33	-36	-37	-37	-36	-37	-37	-36
5820	-38	-40	-38	-38	-39	-36	-34	-34	-34	-31
5830	-30	-29	-25	-22	-21	-20	-20	-17	-16	-17
5840	-17	-17	-14	-9	-6	-2	1	4	7	7
5850	8	10	13	14	15	16	12	9	6	3
5860	0	-1	-6	-12	-17	-22	-26	-31	-34	-38
5870	-41	-44	-48	-49	-51	-52	-53	-54	-55	-52
5880	-51	-51	-49	-48	-48	-45	-41	-37	-33	-30

TO BE CONTINUED

CONTINUED(S-2107 SOUTH)

NO.	(1)	(2)	(3)	(4)	(5)	(6)	(7)	(8)	(9)	(10)
5890	-26	-22	-16	-10	-6	-4	-1	4	8	12
5900	14	16	20	22	23	25	26	29	33	36
5910	61	65	50	55	56	57	59	62	67	70
5920	72	74	76	78	78	77	76	73	70	65
5930	57	49	41	32	25	18	8	0	-10	-19
5940	-30	-39	-48	-57	-65	-73	-80	-85	-90	-93
5950	-94	-94	-95	-96	-96	-94	-92	-91	-88	-84
5960	-81	-76	-70	-66	-60	-53	-47	-40	-31	-22
5970	-13	-4	4	14	22	28	37	43	52	61
5980	69	76	84	91	98	104	110	116	123	131
5990	137	143	148	153	154	155	156	156	156	154

END

RECORD = S-2107 COMPONENT = EAST STATION = CHIBA-S
 DATE AND TIME = 1988-12-17-11-08 TOTAL NUMBER OF DATA = 6000
 SAMPLING INTERVAL = 0.010 (SEC) SCAL = 0.10000
 SIGNAL = GR. ACC. CONNECTION POINT IN DATA NUMBER = 2947, 5908, 6000,

NO.	(1)	(2)	(3)	(4)	(5)	(6)	(7)	(8)	(9)	(10)
0	-98	-92	-87	-82	-77	-72	-67	-62	-55	-48
10	-40	-32	-24	-14	2	20	37	54	65	75
20	85	86	73	59	46	24	-2	-18	-14	-9
30	-5	-1	1	1	-3	-7	-22	-38	-76	-136
40	-172	-162	-147	-72	3	39	68	76	79	52
50	15	-18	-51	-79	-105	-104	-98	-73	-50	-28
60	-23	-26	-64	-95	-114	-118	-110	-49	-4	21
70	29	16	32	-141	-238	-296	-284	-241	-178	-104
80	-58	-37	-14	1	12	20	18	11	1	-8
90	-22	-33	-44	-63	-81	-110	-140	-163	-180	-169
100	-147	-113	-72	-36	3	22	34	43	47	46
110	57	68	94	121	139	145	122	-10	-85	-147
120	-150	-82	17	100	165	162	129	-33	-154	-292
130	-359	-353	-281	-179	-47	109	206	202	151	44
140	-52	-97	-86	-45	30	70	52	-30	-158	-283
150	-335	-321	-244	-147	-54	-2	-17	-91	-225	-320
160	-329	-218	-49	93	154	132	43	-78	-163	-219
170	-242	-175	-37	121	224	226	163	66	-14	-46
180	-47	-35	-57	-23	-27	-23	-4	27	71	134
190	218	169	2	-156	-267	-319	-305	-203	-67	35
200	87	81	37	3	-48	-94	-55	6	36	39
210	19	-2	-56	-125	-154	-178	-107	-74	227	247
220	-19	-231	-353	-423	-389	-277	-176	74	227	247
230	181	82	-110	-194	-191	-114	42	228	260	229
240	126	5	-85	-90	-67	99	167	203	197	168
250	99	31	-15	13	96	152	166	145	106	68
260	17	-26	-7	42	77	99	90	42	-20	-143
270	-272	-354	-317	-277	-221	-157	-101	-50	-9	27
280	56	46	22	-28	-133	-254	-399	-501	-571	-535
290	-403	-280	-94	27	74	73	31	-54	-146	-196
300	310	231	-212	-159	-65	64	199	319	346	355
310	315	244	110	-29	-58	-119	-35	-22	54	355
320	-62	-67	-100	-132	-162	-159	-40	34	55	24
330	2	-81	-144	-205	-230	-200	-159	-118	-78	-63
340	-83	-117	-147	-126	-39	56	103	132	125	88
350	34	-22	-58	-55	-21	14	48	61	64	51
360	23	-47	-149	-226	-291	-330	-336	-296	-153	69
370	210	282	316	322	299	232	162	3	-70	-73
380	29	98	152	171	141	99	43	-5	-36	-89
390	-62	-58	-12	13	-34	-92	-219	-292	-345	-375
400	-533	-522	-91	24	57	46	-37	-112	-173	-185
410	-145	-63	5	29	41	22	-1	-8	26	159
420	302	363	362	323	123	127	-23	-280	-308	-235
430	53	92	140	147	105	60	6	-47	-66	-54
440	-34	-16	-2	21	40	59	80	104	130	147
450	140	117	78	37	-15	-31	-58	-88	-113	33
460	-156	-209	-256	-247	-216	-171	-122	-109	-88	-74
470	-63	-46	-34	-24	-16	4	26	73	105	120
480	86	35	-14	-43	8	195	428	569	629	663

TO BE CONTINUED

TO BE CONTINUED

CONTINUED(S-2107 EAST)

	(1)	(2)	(3)	(4)	(5)	(6)	(7)	(8)	(9)	(10)
1030	-473	-487	-492	-476	-450	-411	-384	-364	-353	-333
1040	334	358	389	-425	-455	-485	-478	-472	-489	-295
1050	-162	0	114	174	202	188	168	135	71	0
1060	-50	-67	-54	-32	-8	17	44	74	145	194
1070	277	333	448	600	636	638	581	479	337	137
1080	-67	-229	-344	-402	-397	-350	-254	-76	39	107
1090	164	162	123	92	40	-20	-52	-47	4	68
1100	120	188	262	296	291	271	238	198	126	17
1110	-55	-89	-87	-72	-47	-22	-15	-26	-61	-103
1120	-143	-192	-249	-284	-284	-284	-284	-300	-372	-400
1130	-405	-452	-491	-477	-394	-261	-143	-38	82	180
1140	244	276	336	404	515	576	658	743	749	717
1150	656	580	502	425	356	308	257	206	128	45
1160	-11	-45	-72	-85	-94	-112	-145	-223	-310	-371
1170	-488	-582	-613	-614	-571	-523	-428	-289	-118	44
1180	133	177	168	139	71	-35	-175	-294	-369	-429
1190	445	-406	-315	-183	-22	197	388	486	520	502
1200	467	320	220	148	104	92	94	97	87	37
1210	-111	-280	-449	-575	-701	-757	-712	-517	-280	-49
1220	177	294	310	287	235	114	66	66	87	124
1230	143	184	198	174	398	323	171	-38	-114	-62
1240	272	369	414	398	323	171	-38	-151	-195	-182
1250	-144	-91	-6	33	59	69	67	59	80	156
1260	240	317	380	426	447	459	416	334	230	96
1270	-50	-167	-258	-290	-279	-230	-122	14	119	181
1280	211	208	187	158	98	10	-90	-151	-192	-235
1290	-271	-303	-399	-292	-257	-130	-25	47	104	131
1300	115	22	-64	-256	-347	-435	-497	-514	-497	-444
1310	-362	-269	-12	-86	-39	-21	-24	-41	-57	-59
1320	-18	53	131	212	316	396	475	511	507	491
1330	465	428	387	357	357	373	387	397	389	360
1340	265	138	19	-113	-238	-322	-378	-421	-446	-440
1350	-428	-417	-391	-370	-345	-319	-347	-428	-483	-331
1360	-557	-613	-644	-644	-601	-533	-446	-360	-272	-165
1370	-58	5	51	118	153	176	207	206	190	176
1380	138	112	125	208	334	406	497	623	749	775
1390	801	806	793	756	689	609	532	456	392	347
1400	307	268	244	215	181	149	99	29	18	10
1410	3	6	9	4	-9	-29	-46	-62	-75	-83
1420	-91	-103	-123	-150	-167	-189	-216	-243	-244	-216
1430	-186	-163	-148	-146	-165	-189	-227	-306	-394	-478
1440	-549	-586	-582	-563	-544	-513	-486	-470	-460	-455
1450	-446	-435	-415	-379	-350	-269	-187	-44	89	170
1460	244	287	331	369	422	493	537	575	606	611
1470	595	575	493	371	224	70	-31	-96	-188	-244
1480	-223	-187	-155	-111	-79	-62	-50	-33	-61	-61
1490	-47	-21	25	82	131	190	262	306	334	326
1500	299	240	145	54	1	-22	-42	-37	-19	-7
1510	-1	-9	-31	-59	-100	-159	-149	-154	-144	-124
1520	-108	-95	-85	-88	-105	-138	-179	-228	-294	-324
1530	-324	-309	-278	-229	-167	-130	-86	-28	19	51
1540	92	124	151	171	200	200	199	196	214	244
1550	294	348	389	411	404	366	286	167	5	131
1560	-237	-248	-199	-87	33	141	217	263	282	276

TO BE CONTINUED

CONTINUED(S-2107 EAST)

	(1)	(2)	(3)	(4)	(5)	(6)	(7)	(8)	(9)	(10)
1570	245	190	127	55	-21	-75	-126	-174	-224	-267
1580	-291	-293	-282	-250	-215	-179	-151	-126	-100	-88
1590	-97	-115	-135	-174	-205	-215	-210	-191	-163	-128
1600	-101	-78	-71	-80	-99	-175	-239	-297	-340	-377
1610	403	-406	-397	-378	-334	-285	-249	-207	-176	-133
1620	-97	-87	-84	-79	-68	-48	13	137	216	319
1630	447	530	673	706	713	703	668	610	531	472
1640	396	350	276	276	300	339	371	394	390	351
1650	254	187	-3	-101	-178	-207	-165	-92	-4	61
1660	93	107	111	111	111	117	123	124	121	103
1670	68	21	-20	-44	-60	-89	-90	-82	-76	-74
1680	-72	-81	-95	-121	-142	-138	-154	-179	-221	-233
1690	-241	-253	-262	-271	-288	-319	-365	-431	-469	-513
1700	-557	-559	-484	-365	-232	-103	67	231	309	342
1710	350	332	302	256	222	257	328	387	430	472
1720	493	499	485	455	419	339	254	183	112	40
1730	-15	-63	-104	-134	-152	-153	-149	-149	-162	-180
1740	-200	-221	-249	-279	-306	-312	-297	-235	-177	-126
1750	-96	-58	-30	-41	-53	-66	-73	-56	-29	1
1760	47	142	206	258	324	353	358	349	324	273
1770	202	171	71	21	11	8	11	-6	-17	-33
1780	-52	-73	-95	-119	-144	-177	-194	-198	-187	-171
1790	-137	-97	-50	6	69	155	249	332	418	465
1800	493	495	479	452	424	384	328	284	239	187
1810	131	63	-3	-62	-114	-133	-135	-117	-110	-108
1820	-112	-126	-151	-188	-216	-243	-261	-283	-285	-291
1830	-291	-291	-289	-292	-289	-240	-21	-183	-135	-87
1840	-58	-31	-22	-26	-26	-42	-25	1	45	90
1850	152	206	246	262	260	236	187	120	62	-16
1860	-87	-118	-126	-131	-148	-156	-162	-168	-172	-177
1870	-183	-190	-202	-214	-226	-240	-249	-260	-267	-268
1880	-246	-204	-151	-101	-62	-26	15	48	107	137
1890	184	236	270	290	314	326	328	322	336	338
1900	340	337	342	338	328	314	295	272	255	246
1910	238	231	217	196	182	166	139	118	86	87
1920	96	98	99	99	87	65	27	-35	-110	-187
1930	-251	-297	-346	-380	-402	-426	-449	-461	-449	-423
1940	-393	-354	-298	-233	-182	-143	-115	-126	-151	-179
1950	-201	-207	-191	-161	-113	-53	1	67	79	106
1960	126	133	132	124	121	123	131	140	149	162
1970	171	180	186	195	201	203	200	197	191	178
1980	171	188	179	188	198	210	221	232	221	181
1990	138	73	12	-40	-76	-106	-94	-96	-90	-99
2000	-91	-100	-122	-145	-167	-188	-199	-209	-228	-242
2010	-260	-288	-303	-328	-358	-378	-383	-379	-376	-373
2020	-375	-380	-384	-381	-371	-355	-325	-263	-167	-65
2030	10	60	94	108	108	99	92	81	79	101
2040	128	155	184	214	238	274	311	346	374	422
2050	466	481	489	480	459	397	321	258	204	165
2060	139	132	138	142	133	123	102	64	26	-22
2070	-67	-90	-108	-149	-171	-188	-207	-225	-242	-252
2080	-243	-232	-223	-213	-190	-182	-182	-193	-202	-216
2090	-220	-214	-198	-174	-151	-130	-111	-93	-92	-101
2100	-106	-114	-130	-142	-144	-137	-131	-126	-121	-118

TO BE CONTINUED

CONTINUED (S-2107 EAST)

CONTINUED (S-2107 EAST)

NO.	(1)	(2)	(3)	(4)	(5)	(6)	(7)	(8)	(9)	(10)
2110	-123	-132	-144	-154	-166	-182	-198	-192	-164	-129
2120	-95	-56	-8	42	89	120	146	167	192	228
2130	245	245	241	232	230	215	211	220	234	244
2140	256	266	266	254	237	203	180	131	99	87
2150	77	66	59	65	53	41	25	16	2	6
2160	6	6	2	-11	-27	-35	-50	-67	-93	-123
2170	-143	-167	-192	-209	-219	-207	-198	-195	-194	-198
2180	-203	-216	-231	-243	-252	-266	-280	-270	-248	-229
2190	-206	-181	-155	-133	-111	-87	-62	-38	-21	7
2200	21	36	44	54	62	74	85	97	112	120
2210	118	113	104	91	79	70	63	71	77	84
2220	101	101	101	105	107	112	122	123	129	134
2230	139	145	137	128	105	73	14	-31	-93	-129
2240	-143	-155	-127	-110	-89	-79	-67	-61	-59	-61
2250	-70	-76	-86	-95	-100	-99	-94	-84	-77	-68
2260	-60	-59	-66	-76	-83	-109	-126	-145	-162	-173
2270	-172	-154	-137	-122	-102	-74	-49	-18	8	36
2280	58	85	112	143	177	207	235	255	265	271
2290	243	232	217	208	207	219	234	250	268	286
2300	392	271	258	208	119	-2	-71	-130	-219	-252
2310	-280	-298	-301	-278	-249	-213	-193	-174	-160	-144
2320	-131	-127	-126	-141	-153	-160	-158	-154	-156	-159
2330	-155	-150	-148	-154	-157	-155	-161	-164	-161	-157
2340	-164	-168	-164	-153	-141	-129	-110	-90	-60	-23
2350	8	40	77	113	140	159	179	204	215	223
2360	240	250	261	276	288	289	296	289	269	250
2370	227	158	95	20	-52	-95	-122	-102	-80	-60
2380	-34	-8	23	39	55	65	69	81	83	91
2390	101	101	101	95	80	53	18	-21	-60	-106
2400	-154	-164	-178	-187	-198	-210	-226	-241	-262	-276
2410	-282	-293	-292	-282	-265	-237	-197	-142	-81	-29
2420	11	61	100	112	128	146	154	157	164	168
2430	172	181	186	186	181	160	138	114	92	70
2440	30	5	1	1	0	0	-11	-47	-68	-98
2450	-122	-142	-176	-257	-277	-286	-265	-243	-207	-197
2460	-190	-164	-141	-131	-128	-105	-85	-78	-72	-64
2470	-56	-50	-48	-51	-65	-75	-85	-99	-120	-138
2480	-158	-187	-229	-223	-200	-180	-159	-122	-83	-68
2490	-54	-37	-24	-23	-35	-42	-39	-26	-14	-14
2500	4	13	16	17	25	32	42	56	64	77
2510	90	112	130	141	159	180	193	200	207	207
2520	206	206	200	192	189	178	174	159	135	127
2530	124	122	121	102	101	83	83	64	54	40
2540	45	28	26	16	3	-10	-27	-34	-43	-49
2550	-51	-67	-83	-98	-108	-117	-132	-148	-165	-179
2560	-186	-189	-191	-189	-181	-173	-164	-155	-143	-133
2570	-131	-120	-109	-100	-100	-105	-110	-115	-122	-127
2580	-129	-122	-110	-97	-81	-57	-38	-25	-7	14
2590	35	25	23	10	-16	-28	-38	-47	-50	-36
2600	-50	-27	-20	-27	-37	-65	-78	-91	-104	-105
2610	-92	-71	-49	-27	0	5	32	59	64	65
2620	60	55	50	44	35	20	8	-3	-16	-26
2630	-37	-51	-65	-71	-71	-64	-46	-33	-13	7
2640	47	86	102	115	129	149	159	154	151	148
2650	143	134	126	115	109	98	86	73	51	23
2660	-5	-33	-51	-79	-102	-111	-111	-99	-84	-58
2670	-28	-3	17	53	41	34	15	-15	-44	-68
2680	-101	-130	-190	-206	-228	-229	-237	-218	-202	-184
2690	-164	-149	-124	-105	-95	-81	-72	-63	-26	8
2700	25	36	61	67	74	74	51	24	6	32
2710	-57	-89	-103	-91	-81	-72	-61	-55	-54	-34
2720	-58	-67	-74	-79	-80	-75	-65	-44	-28	-18
2730	-9	-8	-7	-7	-14	-19	-16	-9	1	12
2740	23	39	49	57	71	74	79	81	78	67
2750	56	43	27	19	8	0	-13	-16	-13	-13
2760	4	12	23	36	42	65	65	95	108	123
2770	151	177	193	214	228	232	226	218	206	186
2780	166	150	132	112	91	65	42	24	2	2
2790	-21	-24	-35	-44	-54	-66	-76	-85	-90	-97
2800	-105	-105	-105	-105	-105	-105	-105	-105	-105	-105
2810	-82	-78	-72	-62	-56	-51	-48	-48	-48	-48
2820	-45	-46	-37	-34	-32	-28	-28	-34	-31	-38
2830	-38	-46	-52	-56	-64	-72	-73	-66	-59	-51
2840	-50	-45	-41	-34	-31	-31	-34	-29	-26	-21
2850	-21	-18	-11	-6	0	5	6	1	-5	-5
2860	-7	-13	-21	-34	-43	-53	-61	-75	-85	-93
2870	-89	-77	-61	-49	-35	-20	-4	10	16	12
2880	8	2	-9	-21	-30	-39	-48	-57	-68	-80
2890	-41	-36	-34	-37	-48	-55	-62	-66	-75	-83
2900	-86	-91	-89	-89	-92	-99	-101	-100	-88	-81
2910	-70	-66	-63	-63	-60	-69	-72	-80	-84	-71
2920	-55	-40	3	23	26	29	51	46	47	39
2930	111	141	167	187	198	210	204	188	164	138
2940	117	77	40	21	-5	-32	-48	-64	-73	-94
2950	-112	-131	-152	-173	-193	-214	-231	-240	-243	-242
2960	-232	-215	-199	-185	-173	-166	-163	-164	-166	-169
2970	-171	-171	-171	-171	-169	-167	-163	-153	-136	-114
2980	-88	-60	-33	-7	18	63	68	91	111	131
2990	159	187	209	225	241	253	261	266	272	279
3000	287	297	307	317	326	333	337	336	328	310
3010	286	293	299	312	324	332	337	336	328	310
3020	12	-22	-58	-100	-151	-200	-244	-282	-315	-341
3030	-356	-368	-377	-380	-378	-371	-355	-332	-306	-273
3040	-239	-214	-198	-185	-173	-161	-153	-146	-138	-130
3050	-120	-113	-108	-105	-105	-104	-103	-101	-96	-90
3060	-82	-69	-51	-28	-5	30	67	106	153	197
3070	225	252	272	284	289	287	283	277	273	268
3080	263	260	257	253	247	240	229	211	190	166
3090	140	112	81	51	27	4	-16	-32	-44	-57
3100	-68	-79	-91	-106	-121	-129	-134	-140	-147	-153
3110	-160	-168	-177	-188	-199	-208	-216	-221	-224	-221
3120	-212	-197	-177	-153	-129	-103	-79	-57	-37	-19
3130	-7	0	9	18	29	41	55	69	83	95
3140	109	128	147	162	177	193	204	209	211	209
3150	202	190	181	173	162	153	145	138	133	124
3160	110	92	74	51	26	6	-17	-39	-51	-57
3170	-60	-57	-52	-48	-44	-39	-34	-31	-28	-27
3180	-23	-17	-8	1	9	16	22	25	24	23

TO BE CONTINUED

TO BE CONTINUED

CONTINUED (S-2107 EAST)

NO.	(1)	(2)	(3)	(4)	(5)	(6)	(7)	(8)	(9)	(10)
3190	21	18	16	18	20	21	19	9	-6	-28
3200	-57	-81	-122	-152	-183	-206	-229	-247	-259	-289
3210	-279	-285	-289	-286	-283	-278	-272	-262	-250	-236
3220	-207	-173	-137	-99	-54	-7	26	52	74	96
3230	107	114	118	117	116	111	107	103	101	101
3240	100	97	94	88	79	68	54	41	32	26
3250	25	28	36	48	57	63	65	65	61	61
3260	57	52	51	51	52	54	57	61	65	68
3270	70	72	73	75	79	81	81	82	86	90
3280	94	99	109	114	118	121	122	126	127	129
3290	128	120	105	87	68	47	29	13	-2	-12
3300	-22	-32	-43	-53	-60	-67	-73	-77	-79	-79
3310	-79	-78	-78	-78	-78	-80	-85	-89	-92	-94
3320	-98	-102	-104	-106	-108	-111	-114	-116	-116	-116
3330	-115	-116	-118	-122	-124	-125	-122	-117	-107	-92
3340	-73	-52	-31	-12	2	13	20	25	26	27
3350	28	28	28	30	33	34	34	33	33	34
3360	36	38	42	44	45	46	46	47	48	48
3370	44	43	39	35	30	26	24	23	24	24
3380	24	25	25	26	29	29	28	28	29	27
3390	26	27	23	20	19	20	22	23	24	27
3400	29	25	17	8	-1	-10	-15	-16	-14	-10
3410	-7	-5	1	2	0	-5	-10	-16	-22	-28
3420	-33	-38	-42	-44	-44	-44	-43	-42	-41	-39
3430	-41	-46	-51	-58	-66	-74	-82	-90	-95	-101
3440	-108	-113	-116	-118	-118	-115	-106	-91	-69	-49
3450	-30	-14	-1	8	16	25	34	41	52	59
3460	67	77	86	96	106	110	107	97	80	59
3470	61	43	23	3	-13	-23	-30	-35	-37	-38
3480	-39	-41	-45	-46	-48	-47	-46	-45	-35	-28
3490	19	18	14	10	-6	-1	4	9	14	18
3500	-24	-19	-14	-10	-6	-1	4	9	14	18
3510	-3	-4	-2	-1	0	2	7	13	16	18
3520	20	19	16	11	2	-4	-12	-18	-25	-30
3530	-34	-36	-38	-39	-39	-38	-36	-30	-23	-16
3540	8	0	11	25	40	53	66	77	83	87
3550	90	91	89	89	84	78	70	60	47	30
3560	36	23	12	0	-7	-12	-16	-18	-20	-21
3570	-21	-21	-22	-21	-18	-15	-13	-11	-12	-15
3580	-20	-28	-36	-44	-51	-57	-61	-64	-67	-70
3590	-74	-76	-76	-77	-80	-80	-77	-71	-63	-64
3600	-47	-42	-37	-32	-31	-30	-30	-31	-38	-46
3610	-57	-66	-76	-82	-85	-86	-84	-77	-67	-55
3620	-43	-34	-25	-15	-9	-2	6	17	25	34
3630	41	46	50	53	55	54	56	57	59	62
3640	65	69	73	78	84	91	98	105	111	117
3650	120	123	124	122	118	112	100	84	67	47
3660	25	4	-13	-28	-41	-48	-52	-57	-60	-64
3670	-70	-77	-84	-92	-99	-108	-113	-120	-124	-127
3680	-120	-131	-130	-126	-118	-106	-94	-80	-63	-48
3690	-35	-23	-13	-4	4	14	26	39	54	69
3700	81	90	98	102	103	105	104	100	96	92
3710	85	76	67	60	53	47	42	38	36	37
3720	38	41	43	46	49	52	55	58	60	61

TO BE CONTINUED

CONTINUED (S-2107 EAST)

NO.	(1)	(2)	(3)	(4)	(5)	(6)	(7)	(8)	(9)	(10)
3730	62	63	63	63	62	60	58	56	52	48
3740	45	42	39	37	34	33	32	31	29	30
3750	32	34	38	43	46	50	52	55	56	54
3760	49	44	38	33	29	26	22	20	19	19
3770	17	15	12	8	3	-4	-12	-20	-28	-35
3780	-41	-43	-45	-45	-44	-44	-44	-44	-43	-43
3790	-38	-33	-30	-27	-24	-21	-20	-21	-21	-21
3800	-22	-24	-26	-27	-28	-30	-32	-35	-38	-40
3810	-42	-41	-44	-46	-47	-48	-48	-45	-38	-30
3820	-21	-11	-1	7	15	20	27	32	37	43
3830	50	58	65	70	72	73	71	70	68	66
3840	65	64	64	61	56	54	51	49	47	45
3850	43	40	37	31	25	15	4	-5	-17	-29
3860	-37	-45	-52	-58	-63	-66	-69	-71	-72	-74
3870	-74	-74	-75	-78	-80	-83	-86	-89	-90	-90
3880	-87	-80	-69	-58	-45	-33	-21	-11	0	8
3890	19	31	44	56	69	81	91	99	106	111
3900	113	115	115	113	108	102	91	76	61	46
3910	30	13	-1	-15	-31	-46	-59	-69	-78	-86
3920	-95	-104	-113	-124	-136	-147	-156	-166	-174	-181
3930	-177	-174	-169	-160	-150	-137	-123	-107	-91	-72
3940	-55	-39	-25	-12	0	12	25	38	50	63
3950	75	86	96	106	117	127	138	150	160	167
3960	173	177	178	176	174	173	170	166	164	164
3970	162	158	155	151	145	139	132	124	113	101
3980	86	70	54	41	33	27	21	17	12	5
3990	0	-9	-15	-27	-39	-47	-58	-67	-76	-82
4000	-87	-82	-85	-97	-97	-96	-93	-91	-87	-83
4010	-77	-68	-58	-45	-32	-18	-5	7	19	31
4020	40	46	48	50	53	56	56	55	51	51
4030	47	42	37	32	25	19	14	10	5	2
4040	0	-1	-1	-2	-3	-4	-6	-7	-10	-15
4050	-21	-28	-36	-46	-57	-69	-83	-97	-110	-129
4060	-35	-39	-42	-49	-53	-56	-59	-63	-65	-70
4070	-77	-82	-84	-85	-84	-77	-72	-67	-63	-63
4080	-60	-57	-56	-54	-54	-54	-56	-59	-64	-67
4090	-72	-76	-78	-77	-73	-69	-65	-60	-53	-46
4100	-41	-36	-30	-23	-15	-7	3	11	22	36
4110	50	64	77	92	105	116	126	133	139	145
4120	150	153	155	156	154	150	144	135	126	116
4130	103	92	82	73	64	53	39	24	9	-6
4140	-17	-27	-37	-48	-56	-65	-74	-82	-91	-97
4150	-101	-104	-107	-109	-108	-107	-106	-105	-101	-97
4160	-93	-90	-88	-83	-76	-68	-68	-64	-61	-57
4170	-52	-47	-40	-32	-25	-18	-11	-4	3	9
4180	14	19	23	26	28	29	31	34	36	38
4190	44	49	52	55	58	61	64	66	64	64
4200	63	61	58	56	51	46	42	39	35	31
4210	30	30	29	28	23	17	10	1	-10	-19
4220	-26	-34	-39	-48	-56	-66	-74	-81	-86	-86
4230	-90	-91	-90	-86	-83	-79	-72	-68	-64	-64
4240	-58	-55	-52	-48	-44	-40	-36	-32	-30	-28
4250	-24	-22	-21	-21	-21	-21	-21	-21	-20	-18
4260	-15	-11	-8	-4	0	3	5	9	14	20

TO BE CONTINUED

CONTINUED(S-2107 EAST)

NO.	(1)	(2)	(3)	(4)	(5)	(6)	(7)	(8)	(9)	(10)
4270	29	40	50	63	77	91	107	123	135	146
4280	156	163	167	168	166	163	160	154	149	145
4290	140	136	129	122	114	106	98	90	82	76
4300	70	65	61	54	45	34	20	5	-10	-25
4310	-38	-49	-56	-61	-66	-71	-76	-80	-86	-94
4320	-102	-110	-118	-125	-129	-134	-137	-140	-142	-146
4330	-143	-145	-145	-143	-140	-138	-135	-133	-129	-126
4340	-120	-114	-105	-91	-75	-59	-41	-25	0	0
4350	12	27	44	63	83	99	113	124	131	138
4360	143	147	152	154	156	157	158	156	154	153
4370	149	144	140	138	135	132	126	121	117	111
4380	103	95	84	75	65	52	39	28	17	4
4390	-4	-11	-17	-23	-28	-34	-39	-43	-46	-49
4400	-51	-53	-54	-55	-57	-60	-62	-66	-71	-74
4410	-78	-80	-80	-80	-78	-77	-78	-78	-78	-78
4420	-80	-80	-80	-80	-80	-80	-78	-76	-72	-67
4430	-60	-50	-39	-29	-19	-10	-1	8	16	24
4440	34	43	52	57	64	71	77	82	86	90
4450	93	95	96	99	99	99	99	99	97	95
4460	92	88	82	78	71	60	48	36	25	15
4470	6	-1	-8	-13	-19	-26	-34	-42	-53	-61
4480	-68	-73	-78	-82	-85	-88	-92	-95	-98	-100
4490	-103	-105	-104	-101	-97	-93	-88	-84	-80	-74
4500	-69	-65	-61	-55	-50	-46	-42	-37	-35	-32
4510	-30	-27	-24	-21	-17	-16	-18	-18	-17	-13
4520	-10	-9	-8	-7	-4	-4	-4	-4	-4	-1
4530	0	1	4	8	13	17	19	23	27	29
4540	33	36	40	43	45	46	46	45	43	41
4550	41	41	41	43	45	47	49	50	51	51
4560	50	48	47	47	46	43	39	35	30	23
4570	14	6	0	-4	-9	-13	-16	-21	-27	-33
4580	-41	-51	-62	-71	-78	-84	-87	-90	-90	-90
4590	-90	-90	-90	-89	-87	-83	-79	-74	-68	-62
4600	-58	-53	-47	-41	-34	-25	-15	-6	3	12
4610	22	32	42	51	63	72	81	89	95	100
4620	103	103	101	98	95	90	87	85	86	84
4630	80	74	68	62	57	52	48	45	42	38
4640	36	34	30	26	22	21	21	21	18	18
4650	13	7	0	-7	-17	-28	-37	-47	-56	-64
4660	-71	-78	-84	-90	-95	-98	-101	-100	-98	-92
4670	-94	-92	-88	-85	-81	-77	-72	-68	-60	-52
4680	-41	-31	-21	-14	-7	0	4	9	17	24
4690	32	41	50	58	65	73	79	86	93	99
4700	105	108	108	107	106	104	102	100	98	96
4710	92	87	81	72	63	53	43	34	24	15
4720	7	-1	-11	-21	-32	-41	-48	-53	-57	-58
4730	-58	-57	-55	-53	-52	-50	-47	-45	-44	-44
4740	-43	-41	-40	-40	-39	-36	-32	-26	-19	-11
4750	-1	8	16	22	29	35	39	44	49	55
4760	60	67	72	74	75	74	71	70	67	62
4770	60	57	56	51	44	35	25	16	6	-2
4780	-10	-17	-26	-35	-45	-52	-58	-64	-72	-77
4790	-81	-84	-87	-90	-92	-93	-93	-92	-89	-84
4800	-77	-67	-57	-47	-37	-26	-17	-9	0	9

TO BE CONTINUED

CONTINUED(S-2107 EAST)

NO.	(1)	(2)	(3)	(4)	(5)	(6)	(7)	(8)	(9)	(10)
4810	17	28	39	48	56	63	68	72	75	75
4820	75	73	71	70	68	64	58	53	47	40
4830	35	31	29	26	24	21	19	15	11	7
4840	-1	-6	-9	-10	-10	-8	-4	1	4	7
4850	10	9	7	3	0	-5	-11	-15	-20	-23
4860	-27	-32	-38	-44	-50	-57	-65	-75	-85	-93
4870	-105	-114	-126	-135	-141	-146	-149	-147	-144	-144
4880	-140	-136	-134	-131	-128	-123	-115	-105	-93	-82
4890	-87	-80	-72	-63	-50	-34	-18	0	7	16
4900	88	97	108	119	131	141	150	158	164	166
4910	169	169	167	166	166	165	163	159	154	147
4920	139	131	123	112	100	87	74	61	48	33
4930	17	1	-15	-31	-46	-61	-72	-80	-86	-91
4940	-95	-99	-102	-105	-108	-111	-116	-121	-124	-126
4950	-126	-127	-126	-124	-122	-120	-118	-117	-116	-114
4960	-111	-108	-104	-99	-94	-88	-80	-70	-62	-53
4970	-4	-4	-4	-4	-4	-4	-4	-4	-3	0
4980	14	16	17	16	15	15	13	11	9	7
4990	14	16	17	16	15	15	13	11	9	7
5000	3	0	-3	-6	-9	-10	-12	-12	-11	-10
5010	-9	-9	-8	-7	-7	-7	-5	-3	-1	0
5020	1	3	3	3	3	3	3	3	3	3
5030	-1	0	3	5	9	12	14	17	19	22
5040	24	27	28	28	31	33	36	38	42	44
5050	44	45	45	42	38	32	28	23	19	16
5060	14	11	10	6	4	1	-2	-5	-8	-10
5070	-13	-14	-15	-16	-15	-15	-16	-18	-17	-16
5080	-16	-16	-16	-16	-16	-16	-16	-16	-16	-16
5090	-10	-11	-13	-13	-13	-14	-16	-18	-20	-21
5100	-23	-25	-26	-26	-25	-24	-23	-20	-17	-14
5110	-14	-11	-9	-6	-4	0	1	3	6	10
5120	15	19	23	27	32	36	38	40	42	41
5130	42	43	41	40	38	35	33	29	25	21
5140	20	20	20	18	16	12	8	5	2	0
5150	-1	-1	0	0	1	1	0	0	0	0
5160	0	1	4	9	15	21	27	31	34	39
5170	43	48	54	60	65	69	73	76	76	77
5180	78	78	77	76	74	72	70	67	65	62
5190	60	58	57	56	55	51	46	40	36	32
5200	28	24	19	15	7	1	-7	-14	-22	-30
5210	-35	-40	-44	-48	-49	-51	-54	-54	-54	-53
5220	-51	-50	-47	-45	-41	-40	-40	-40	-39	-38
5230	-38	-39	-39	-40	-42	-46	-47	-51	-54	-58
5240	-62	-65	-69	-71	-71	-72	-72	-71	-71	-71
5250	-71	-71	-71	-70	-68	-66	-63	-59	-56	-52
5260	-47	-42	-36	-30	-25	-19	-13	-8	-1	4
5270	10	15	20	22	24	27	30	33	37	38
5280	38	39	38	35	33	31	28	25	24	24
5290	21	19	16	14	12	9	6	4	4	1
5300	-3	-3	-3	-3	-3	-3	-3	-3	-3	-3
5310	-41	-45	-46	-48	-49	-48	-47	-46	-44	-42
5320	-40	-40	-40	-38	-36	-31	-26	-19	-13	-9
5330	-5	0	7	17	27	36	47	59	69	76
5340	80	85	90	98	105	110	113	117	119	119

TO BE CONTINUED

CONTINUED (S-2107 EAST)

NO.	(1)	(2)	(3)	(4)	(5)	(6)	(7)	(8)	(9)	(10)
5350	118	116	113	109	107	103	99	95	88	81
5360	71	64	56	47	38	29	20	13	5	-1
5370	-7	-12	-17	-20	-24	-27	-31	-36	-39	-43
5380	-46	-48	-50	-51	-52	-52	-51	-50	-47	-45
5390	-43	-41	-39	-38	-39	-38	-38	-39	-39	-39
5400	-38	-37	-34	-31	-28	-27	-26	-26	-27	-28
5410	-28	-28	-28	-27	-26	-25	-23	-19	-17	-16
5420	-16	-15	-12	-11	-9	-8	-6	-4	0	1
5430	2	4	3	2	0	-1	-3	-4	-5	-4
5440	-4	-4	-5	-6	-8	-9	-10	-10	-10	-10
5450	-8	-5	-2	2	4	9	15	22	30	37
5460	42	47	51	55	58	61	63	63	63	64
5470	65	65	65	63	60	56	52	47	44	41
5480	38	33	27	20	14	8	1	-4	-8	-10
5490	-12	-15	-19	-23	-27	-30	-34	-38	-42	-45
5500	-47	-49	-52	-56	-60	-62	-67	-71	-75	-78
5510	-81	-84	-85	-87	-90	-91	-90	-89	-89	-85
5520	-81	-78	-75	-69	-64	-61	-59	-58	-55	-50
5530	-45	-39	-32	-23	-17	-9	0	8	18	27
5540	36	47	56	64	75	82	86	90	92	94
5550	93	92	90	88	84	79	73	68	62	56
5560	51	44	37	29	20	13	6	0	-5	-11
5570	-17	-23	-28	-33	-36	-39	-43	-46	-49	-53
5580	-56	-56	-56	-56	-54	-52	-51	-50	-49	-47
5590	-44	-42	-38	-35	-34	-32	-28	-24	-21	-16
5600	-19	-15	-13	-13	-11	-12	-13	-13	-16	-22
5610	-28	-34	-40	-44	-48	-52	-55	-57	-59	-61
5620	-61	-59	-57	-54	-52	-49	-47	-44	-42	-39
5630	-37	-33	-27	-22	-17	-12	-6	-2	0	3
5640	4	6	6	8	12	15	18	20	22	23
5650	25	24	24	26	27	27	26	27	29	29
5660	30	29	26	23	20	18	16	14	10	7
5670	5	3	0	0	-1	-4	-8	-8	-10	-10
5680	-12	-14	-19	-22	-24	-27	-29	-29	-29	-29
5690	-29	-29	-29	-29	-28	-28	-28	-29	-30	-30
5700	-31	-32	-31	-30	-31	-31	-31	-30	-29	-31
5710	-33	-33	-33	-35	-36	-37	-38	-40	-41	-41
5720	-39	-36	-34	-34	-33	-34	-34	-33	-34	-33
5730	-32	-31	-31	-30	-28	-29	-29	-28	-28	-27
5740	-26	-24	-22	-21	-20	-19	-18	-17	-16	-15
5750	-5	0	3	6	11	16	19	23	27	29
5760	33	35	36	38	40	42	46	50	53	56
5770	58	59	59	60	61	61	61	59	55	53
5780	50	46	41	35	30	24	18	11	3	-3
5790	-9	-14	-20	-25	-31	-38	-43	-48	-52	-54
5800	-68	-61	-64	-67	-69	-71	-71	-71	-71	-69
5810	-67	-64	-62	-58	-55	-55	-55	-56	-58	-57
5820	-56	-56	-54	-48	-42	-39	-34	-29	-25	-19
5830	-15	-10	-5	-1	0	4	9	13	18	23
5840	29	34	40	45	49	50	50	51	50	50
5850	48	48	48	49	50	48	47	44	42	39
5860	34	30	25	20	14	7	1	-5	-12	-18
5870	-24	-33	-41	-49	-56	-63	-69	-75	-79	-82
5880	-83	-84	-84	-84	-83	-82	-80	-80	-80	-78

TO BE CONTINUED

CONTINUED (S-2107 EAST)

NO.	(1)	(2)	(3)	(4)	(5)	(6)	(7)	(8)	(9)	(10)
5890	-76	-72	-68	-64	-60	-56	-51	-46	-41	-38
5900	-55	-49	-42	-37	-33	-29	-25	-21	-17	-13
5910	11	16	18	18	18	18	18	18	18	19
5920	20	21	21	21	22	23	24	24	26	29
5930	31	32	35	35	40	42	44	46	47	49
5940	49	50	49	48	46	46	43	39	35	31
5950	27	24	22	19	14	11	8	5	0	-2
5960	-4	-4	-7	-11	-8	-8	-8	-7	-7	-8
5970	-7	-7	-4	-2	0	1	4	4	5	6
5980	9	10	10	13	16	15	14	13	13	15
5990	15	15	16	16	14	13	10	7	5	3

END

RECORD = S-2107 COMPONENT = DOWN STATION = CHIBA-S
 DATE AND TIME = 1988-12-17-11-08 TOTAL NUMBER OF DATA = 6000
 SAMPLING INTERVAL = 0.010 (SEC) SIGNAL = GR. ACC.
 CONNECTION POINT IN DATA NUMBER = 2895, 5856, 6000,

NO.	(1)	(2)	(3)	(4)	(5)	(6)	(7)	(8)	(9)	(10)
0	56	39	22	5	-11	-29	-46	-63	-45	0
10	44	88	133	157	166	175	183	129	-24	-178
20	-312	-307	-304	-293	-264	-253	-240	-228	-256	-282
30	-181	-92	-2	54	81	51	-206	-256	-282	-282
40	-242	-166	-94	-86	-79	-297	-435	-479	-431	-360
50	-265	-75	113	306	478	476	486	434	280	126
60	-40	-202	-399	-367	-384	-296	-191	-37	84	171
70	129	124	170	180	161	112	56	14	-4	-22
80	-36	-46	-46	-35	-19	0	6	24	49	74
90	-309	-336	-168	-67	-65	-121	-190	-249	-297	-265
100	-342	-288	-337	-146	-51	-19	-62	-65	-47	-39
110	-50	3	185	167	139	89	12	-20	20	20
120	130	126	269	333	272	118	-133	-366	-434	-403
130	-122	-54	-58	-80	-25	76	113	-16	-142	-120
140	-9	104	122	40	-23	-90	-91	-87	-96	-126
150	-154	-74	113	216	166	-36	-296	-356	-314	-138
160	23	57	61	60	81	105	83	-59	-51	-16
170	80	174	156	17	-171	-320	-329	-290	-252	-235
180	-112	-14	57	11	-21	4	91	171	174	138
190	75	-22	-102	-110	-59	35	129	204	271	274
200	208	34	-108	-177	-173	-156	-142	-133	-132	-148
210	-222	-268	-230	-163	-115	-77	-61	-52	-53	-61
220	3	59	94	117	134	107	56	1	-72	-168
230	-214	-213	-153	-82	-39	-9	-1	28	62	74
240	85	97	97	94	64	-31	-131	-150	-116	-71
250	-12	0	-9	-20	-53	-80	-106	-118	-69	-15
260	82	129	125	98	105	130	162	192	204	185
270	153	46	-19	57	133	110	46	-23	-53	-37
280	-23	-40	-68	-99	36	157	230	177	85	-62
290	-128	-87	89	235	292	287	232	97	1	-49
300	-87	-100	-172	-265	-259	-170	-141	-153	-172	-183
310	-22	60	133	101	73	99	135	95	-43	-195
320	-264	-215	-84	106	160	161	82	-10	-61	-21
330	4	7	-6	-57	-140	-167	-182	-179	-169	-165
340	-158	-141	-109	-54	-5	20	47	57	50	42
350	50	90	129	143	129	89	52	94	217	278
360	295	214	150	153	166	149	104	27	-25	-66
370	-25	-77	-135	-187	-241	-217	-95	-7	14	21
380	25	32	25	-16	-117	-249	-289	-283	-240	-196
390	-193	-182	-194	-249	-273	-249	-209	-166	-127	-76
400	410	-70	-51	-5	70	113	149	185	213	214
410	199	207	212	212	208	203	198	194	193	200
420	199	167	88	-67	-207	-276	-318	-354	-367	-398
430	430	199	167	88	-67	-207	-276	-318	-354	-367
440	-373	-270	-141	-26	54	50	40	28	51	77
450	98	136	139	86	-58	-141	-117	-79	-37	-33
460	-85	-191	-260	-248	-128	40	71	25	-19	-82
470	-111	-131	-157	-196	-207	-171	-147	-123	-127	-141
480	-118	17	213	305	299	232	162	131	114	114

TO BE CONTINUED

TO BE CONTINUED

CONTINUED (S-2107 DOWN)

NO.	(1)	(2)	(3)	(4)	(5)	(6)	(7)	(8)	(9)	(10)
1030	-178	-163	-163	-155	-138	-104	-38	63	87	142
1040	198	216	177	122	54	3	-55	-63	-112	-140
1050	-129	-109	-74	-48	-25	25	80	105	143	199
1060	167	182	174	155	113	39	-43	-79	-91	-31
1070	46	144	194	222	231	178	75	-43	-125	-160
1080	-147	-103	-68	-19	25	27	9	-109	-67	-72
1090	-41	-7	13	30	109	3	-50	-87	-118	-94
1100	-68	-39	0	61	104	126	111	88	72	71
1110	65	40	17	-7	-19	-50	-134	-203	-223	-215
1120	-177	-131	-101	-76	-65	-67	-88	-105	-112	-116
1130	-80	1	63	102	140	162	182	185	175	167
1140	161	156	163	153	118	74	41	-20	-64	-108
1150	-164	-131	-102	-20	36	85	102	67	26	-30
1160	-51	-45	-36	-29	-26	-25	-61	-81	-92	-90
1170	-89	-81	-63	-54	-56	-64	-94	-37	-180	-175
1180	-139	-102	-53	-8	11	4	-7	-24	-35	4
1190	44	63	85	106	112	109	107	117	141	154
1200	151	132	79	13	-38	-82	-110	-124	-109	-83
1210	-58	-32	0	9	29	62	92	143	201	233
1220	269	248	207	104	39	-12	-58	-92	-123	-142
1230	-188	-210	-193	-155	-136	-64	-61	23	62	100
1240	127	171	208	183	153	99	-9	-144	-181	-224
1250	-253	-281	-267	-228	-228	-228	-228	-158	-48	103
1260	130	123	99	71	64	51	40	27	12	12
1270	21	22	6	-11	-20	-25	15	3	22	40
1280	47	78	-5	-45	-105	-130	-136	-126	-116	-110
1290	-95	-71	-30	7	68	136	200	230	245	240
1300	223	200	159	60	-19	-70	-107	-165	-182	-206
1310	-220	-232	-239	-238	-212	-154	-110	-59	-42	-15
1320	7	25	16	11	0	0	18	49	79	104
1330	123	129	129	128	121	100	61	30	4	-7
1340	-4	-8	-35	-63	-83	-106	-114	-104	-77	-48
1350	-24	-3	-2	-32	-61	-88	-112	-121	-113	-98
1360	-88	-80	-70	-55	-31	-23	-12	0	8	16
1370	27	44	55	61	71	82	100	114	125	138
1380	152	152	144	121	109	99	67	51	73	73
1390	93	114	123	112	91	50	31	19	11	31
1400	39	48	44	31	3	-15	-36	-62	-80	-91
1410	-92	-74	-66	-57	-42	-22	-10	4	21	43
1420	63	68	70	59	30	1	-15	-30	-51	-71
1430	-85	-99	-127	-158	-169	-170	-162	-152	-144	-137
1440	-127	-119	-112	-105	-93	-85	-71	-61	-53	-68
1450	-45	-37	-42	-46	-56	-58	-62	-64	-77	-77
1460	-66	-48	-48	19	51	78	110	151	180	202
1470	217	227	229	231	231	230	227	217	201	169
1480	120	51	14	-53	-86	-116	-157	-201	-223	-226
1490	-196	-158	-141	-116	-84	-49	-10	30	69	110
1500	130	127	121	109	85	54	24	-1	-32	-71
1510	-106	-128	-143	-148	-156	-166	-183	-193	-196	-197
1520	-185	-163	-125	-72	-17	41	73	101	134	153
1530	168	159	152	117	114	114	94	76	59	37
1540	12	-3	-12	-18	-37	-22	16	37	55	85
1550	108	124	156	187	218	242	264	255	226	193
1560	127	45	-24	-93	-143	-172	-184	-189	-186	-179

TO BE CONTINUED

CONTINUED (S-2107 DOWN)

NO.	(1)	(2)	(3)	(4)	(5)	(6)	(7)	(8)	(9)	(10)
1570	-140	-131	-106	-82	-57	-34	-10	21	51	79
1580	101	112	119	119	116	109	98	78	58	29
1590	1	-23	-55	-104	-141	-166	-197	-191	-174	-149
1600	-121	-100	-87	-65	-54	-16	11	26	39	61
1610	73	86	101	98	90	90	90	90	92	82
1620	82	79	67	51	40	17	16	34	43	42
1630	-44	-33	-54	-59	-63	-63	-65	-67	-72	-77
1640	-75	-71	-57	-32	-22	-7	23	46	74	98
1650	103	94	77	51	15	-15	-27	-38	-35	-22
1660	-1	20	36	46	44	49	49	38	23	15
1670	9	0	-11	-14	-14	-14	1	13	31	45
1680	46	42	37	29	13	-9	-38	-58	-68	-85
1690	-87	-70	-62	-37	-16	38	58	55	68	73
1700	94	94	94	94	93	90	90	85	71	66
1710	60	47	39	32	17	2	-26	-40	-41	-26
1720	-4	17	34	48	56	56	56	39	6	-16
1730	-38	-51	-91	-91	-99	-111	-99	-73	-50	-25
1740	-6	10	28	36	35	39	34	27	30	27
1750	15	-5	-32	-13	-67	-80	-92	-102	-106	-95
1760	-70	-62	-22	-13	2	14	40	48	58	72
1770	89	99	95	87	72	63	54	55	72	86
1780	111	134	150	161	160	145	96	32	-34	-81
1790	-97	-108	-110	-106	-98	-88	-77	-69	-51	-40
1800	-15	26	57	81	109	126	129	123	103	80
1810	50	20	40	-24	-46	-62	-78	-94	-111	-123
1820	-130	-130	-109	-72	-39	-15	-2	15	20	26
1830	33	42	55	70	82	83	78	65	61	48
1840	19	2	-12	-20	-24	-14	-14	-16	-13	-10
1850	-6	-3	4	10	16	27	27	26	10	-21
1860	-31	-37	-61	-75	-82	-79	-66	-39	-14	10
1870	29	40	50	58	62	62	62	61	59	64
1880	64	50	24	7	-1	-5	10	35	37	34
1890	31	20	15	13	10	10	-1	-9	-13	-17
1900	-24	-32	-35	-42	-52	-62	-64	-72	-74	-85
1910	-94	-114	-137	-145	-159	-166	-171	-174	-156	-131
1920	-117	-14	-14	-65	-40	-14	-4	12	23	36
1930	49	64	66	66	60	53	46	17	17	14
1940	5	1	-11	-25	-51	-69	-76	-84	-84	-77
1950	-63	-55	-43	-31	-6	13	25	43	65	65
1960	84	99	104	102	88	70	55	40	23	6
1970	-6	-19	-25	-29	-32	-37	-51	-60	-62	-58
1980	-39	-24	-8	0	12	25	41	43	42	20
1990	7	-20	-45	-48	-55	-61	-66	-61	-66	-62
2000	-62	-69	-36	-19	3	44	42	41	39	26
2010	23	-6	-13	-15	-8	9	27	40	52	49
2020	38	24	11	5	2	13	31	35	43	45
2030	39	27	15	3	-13	-38	-49	-60	-71	-82
2040	-95	-11	-13	-168	-146	-134	-122	-98	-75	-53
2050	-55	-31	-31	-20	5	7	28	47	59	72
2060	85	99	110	114	110	99	75	46	27	8
2070	-19	-58	-77	-84	-96	-106	-107	-107	-106	-83
2080	-75	-43	-43	-23	-21	-18	-16	-9	14	32
2090	42	47	50	59	64	62	57	56	52	47
2100	34	26	5	-6	-15	-22	-26	-35	-33	-21

TO BE CONTINUED

CONTINUED(S-2107 DOWN)

CONTINUED(S-2107 DOWN)

NO.	(1)	(2)	(3)	(4)	(5)	(6)	(7)	(8)	(9)	(10)
2110	-14	-5	4	10	15	22	28	30	33	36
2120	35	32	29	26	20	16	12	4	-6	-16
2130	-44	-61	-68	-77	-94	-106	-122	-131	-139	-102
2140	-74	-63	-58	-41	-30	27	5	-9	20	29
2150	42	48	41	41	30	27	5	-9	-12	-15
2160	-9	-21	-23	-28	-28	-28	-29	-32	-40	-43
2170	-35	-19	-8	-5	-15	-3	3	15	-22	-29
2180	-32	-25	-19	-8	-2	3	15	33	41	46
2190	58	74	90	98	96	88	75	60	40	24
2200	20	16	20	24	27	27	30	35	36	36
2210	37	39	41	26	16	-2	-24	-41	-53	-68
2220	-83	-89	-84	-92	-100	-100	-106	-107	-109	-82
2230	-94	-88	-84	-72	-57	-50	-53	-56	-52	-52
2240	-41	-33	-23	-19	-15	-8	-1	11	18	30
2250	29	25	22	25	21	16	12	7	8	4
2260	-1	-7	-14	-22	-35	-45	-49	-59	-67	-70
2270	-74	-79	-82	-84	-87	-92	-94	-94	-93	-93
2280	-89	-82	-77	-74	-68	-63	-59	-55	-52	-48
2290	-43	-34	-33	-23	-13	13	28	41	55	56
2300	52	49	43	37	22	18	13	-6	-7	-8
2310	-12	-26	-33	-37	-36	-30	-29	-37	-37	-40
2320	-45	-49	-53	-53	-52	-47	-40	-33	10	15
2330	27	33	38	44	47	48	49	46	39	30
2340	17	4	-2	8	22	26	34	41	45	51
2350	50	38	25	11	-9	-19	-28	-35	-53	-62
2360	-72	-75	-74	-70	-67	-67	-67	-69	-67	-69
2370	-86	-92	-101	-113	-114	-114	-114	-113	-102	-98
2380	-93	-88	-85	-79	-68	-61	-56	-47	-39	-24
2390	-11	0	28	50	66	66	66	69	81	82
2400	71	65	59	49	40	28	15	6	-9	-19
2410	-22	-33	-34	-34	-36	-36	-31	-28	-26	-23
2420	-22	-19	-17	-15	-13	-11	-12	-14	-15	-11
2430	-2	7	21	37	47	49	43	36	32	16
2440	-1	-14	-23	-37	-41	-57	-60	-61	-85	-81
2450	-70	-69	-61	-50	-44	-44	-39	-32	-25	-15
2460	-9	-17	-16	-4	-4	-2	6	12	20	20
2470	21	30	28	20	20	20	20	20	19	17
2480	15	12	3	-2	-3	-4	-10	-19	-21	-22
2490	-22	-23	-25	-25	-25	-25	-25	-28	-30	-30
2500	-31	-32	-34	-36	-39	-46	-49	-55	-60	-55
2510	-49	-42	-33	-23	-11	8	22	32	27	29
2520	30	34	37	37	41	41	40	31	28	16
2530	12	-1	-14	-19	-39	-40	-54	-54	-55	-55
2540	-55	-54	-51	-42	-36	-17	-12	-6	1	7
2550	17	28	35	29	29	34	27	17	17	16
2560	5	5	6	10	8	0	-11	-19	-30	-41
2570	-45	-42	-36	-34	-34	-34	-30	-27	-25	-21
2580	-16	-13	-10	-9	-9	-10	-13	-19	-22	-27
2590	-33	-41	-46	-48	-51	-53	-54	-48	-37	-31
2600	-20	-4	9	12	16	23	27	22	20	20
2610	18	15	11	10	5	-3	1	-6	-12	-25
2620	-26	-33	-25	-25	-19	-12	-5	1	1	17
2630	21	27	26	17	9	3	-4	-11	-19	-26
2640	-34	-41	-48	-60	-71	-73	-68	-67	-64	-59

TO BE CONTINUED

TO BE CONTINUED

CONTINUED(S-2107 DOWN)

NO.	(1)	(2)	(3)	(4)	(5)	(6)	(7)	(8)	(9)	(10)
3190	23	23	23	21	18	12	7	0	-9	-15
3200	-20	-24	-27	-29	-27	-24	-20	-17	-14	-9
3210	-6	-2	1	4	8	12	15	18	21	23
3220	23	22	22	22	21	16	13	10	0	-10
3230	-17	-22	-23	-22	-22	-19	-15	-11	-6	-2
3240	1	7	15	20	28	34	37	35	31	31
3250	25	19	10	-2	-13	-21	-25	-28	-29	-28
3260	-27	-35	-24	-22	-18	-14	-10	-5	1	10
3270	16	19	25	30	34	35	37	37	34	34
3280	29	22	11	-1	-17	-33	-44	-49	-51	-52
3290	-53	-51	-42	-27	-14	2	8	14	17	17
3300	18	21	23	25	26	26	25	20	22	18
3310	16	16	14	11	7	3	0	-2	-5	-6
3320	-8	-8	-9	-9	-7	-5	-4	-3	-5	-9
3330	-13	-17	-21	-28	-32	-37	-40	-42	-42	-41
3340	-41	-40	-38	-35	-32	-28	-23	-21	-18	-16
3350	-16	-14	-11	-7	-4	0	9	17	22	26
3360	32	38	42	41	40	40	40	40	37	37
3370	34	28	21	21	20	14	7	2	-3	-12
3380	-19	-26	-30	-33	-37	-39	-37	-30	-24	-17
3390	-13	-10	-8	-5	-3	-2	-1	0	0	0
3400	0	3	6	10	14	18	21	20	17	15
3410	13	6	-1	-8	-14	-17	-21	-24	-26	-26
3420	-26	-24	-20	-14	-7	0	5	8	10	10
3430	13	15	15	16	17	18	20	22	23	27
3440	31	36	43	51	55	59	65	67	66	64
3450	58	66	76	83	88	91	95	97	94	93
3460	-42	-46	-48	-51	-52	-49	-45	-41	-37	-34
3470	-50	-27	-23	-19	-15	-11	-7	-4	-3	-2
3480	-3	-6	-9	-12	-15	-19	-24	-30	-32	-33
3490	-31	-27	-23	-18	-11	-4	2	10	18	25
3500	34	44	54	62	68	72	76	77	74	69
3510	63	58	52	42	30	16	4	-5	-16	-28
3520	-36	-42	-46	-51	-55	-58	-59	-58	-56	-51
3530	-46	-41	-31	-22	-17	-14	-13	-12	-14	-16
3540	-16	-17	-20	-25	-31	-35	-39	-40	-38	-34
3550	-29	-20	-13	-3	8	17	22	25	28	31
3560	33	34	33	29	25	23	20	14	7	7
3570	-1	-10	-22	-32	-39	-43	-45	-45	-43	-40
3580	-38	-31	-22	-13	-7	-1	3	6	7	8
3590	6	3	-1	-6	-9	-12	-15	-19	-23	-25
3600	-27	-29	-31	-29	-27	-26	-22	-18	-12	-6
3610	0	5	11	16	19	24	29	35	40	42
3620	43	43	41	36	31	27	22	17	14	13
3630	11	8	7	6	5	5	4	-4	-10	-16
3640	-21	-28	-35	-39	-44	-49	-54	-57	-58	-57
3650	-54	-51	-45	-36	-27	-19	-12	-5	1	6
3660	10	14	15	16	19	20	17	15	13	10
3670	9	7	5	1	-1	-3	-5	-4	-8	-8
3680	-7	-6	-4	0	7	16	24	32	38	41
3690	41	41	39	37	33	29	23	18	12	4
3700	-2	-6	-8	-9	-9	-9	-6	-2	2	6
3710	8	11	13	14	17	20	21	21	21	17
3720	10	4	-2	-9	-18	-26	-35	-42	-48	-53

TO BE CONTINUED

TO BE CONTINUED

CONTINUED(S-2107 DOWN)

CONTINUED(S-2107 DOWN)

NO.	(1)	(2)	(3)	(4)	(5)	(6)	(7)	(8)	(9)	(10)
4270	-54	-52	-51	-50	-47	-43	-37	-32	-28	-28
4280	-28	-26	-24	-22	-22	-19	-15	-14	-11	-6
4290	-1	6	14	19	26	30	32	35	37	37
4300	40	38	38	37	34	29	26	24	23	21
4310	19	18	16	15	13	11	11	11	10	6
4320	4	3	0	-1	-1	-1	-1	-1	-2	-4
4330	-3	-3	-4	-5	-6	-8	-8	-9	-12	-14
4340	-12	-10	-9	-9	-10	4	7	10	14	18
4350	20	18	18	19	20	21	22	19	17	17
4360	16	16	16	15	12	11	7	5	1	0
4370	-2	-3	-4	-6	-9	-8	-9	-12	-15	-17
4380	-18	-19	-20	-21	-22	-20	-18	-15	-14	-13
4390	-10	-9	-8	-4	-3	-2	2	9	15	21
4400	28	35	39	46	52	56	60	63	65	66
4410	65	63	61	60	56	53	50	46	43	43
4420	40	36	31	26	21	15	9	4	2	-1
4430	-5	-8	-11	-12	-12	-15	-19	-20	-25	-25
4440	-32	-40	-46	-48	-49	-52	-53	-54	-58	-61
4450	-63	-61	-56	-54	-53	-53	-48	-44	-42	-41
4460	-41	-41	-41	-40	-36	-32	-28	-23	-19	-17
4470	-16	-12	-10	-8	-9	-10	-9	-7	-3	-1
4480	-1	0	5	11	16	19	21	24	29	33
4490	35	37	36	34	33	31	29	28	25	21
4500	19	17	14	11	7	4	2	1	0	0
4510	1	1	2	5	8	10	12	11	10	8
4520	6	4	2	0	-1	-4	-7	-12	-17	-19
4530	-22	-22	-24	-26	-28	-29	-29	-27	-25	-24
4540	-30	-33	-34	-36	-37	-39	-40	-41	-38	-34
4550	30	33	34	36	32	29	25	24	23	23
4560	34	36	35	32	29	26	25	24	23	23
4570	22	18	16	16	16	15	12	10	9	8
4580	4	0	-4	-8	-13	-18	-23	-28	-31	-33
4590	-36	-39	-40	-40	-40	-37	-33	-31	-29	-27
4600	-27	-27	-23	-19	-17	-14	-12	-9	-8	-8
4610	-7	-5	-3	-3	-1	-5	-8	-9	-8	-5
4620	-4	-3	-2	-2	-2	-2	-1	0	3	3
4630	8	11	11	14	17	20	23	28	31	33
4640	35	35	35	35	35	38	39	38	38	38
4650	38	35	30	25	21	19	15	10	3	-1
4660	-3	-9	-17	-23	-25	-27	-29	-30	-32	-33
4670	-33	-31	-28	-28	-29	-29	-26	-23	-24	-24
4680	-27	-23	-18	-18	-15	-12	-12	-13	-14	-14
4690	-11	-8	-7	-5	-4	0	4	7	10	10
4700	13	17	19	20	23	25	27	29	30	30
4710	30	31	30	29	27	25	23	22	20	20
4720	20	19	17	15	13	11	8	6	4	3
4730	2	2	1	0	1	1	-1	-4	-6	-10
4740	-15	-18	-20	-22	-25	-28	-32	-34	-34	-31
4750	-29	-33	-36	-40	-43	-47	-50	-52	-53	-53
4760	-61	-62	-60	-57	-54	-51	-48	-45	-42	-39
4770	-29	-29	-29	-28	-28	-28	-28	-28	-27	-27
4780	-54	-56	-56	-57	-53	-50	-48	-46	-44	-43
4790	-13	-5	1	11	18	23	25	29	33	35
4800	36	39	41	43	45	45	46	46	45	44

TO BE CONTINUED

TO BE CONTINUED

CONTINUED(S-2107 DOWN)

NO.	(1)	(2)	(3)	(4)	(5)	(6)	(7)	(8)	(9)	(10)
5350	48	46	44	44	42	40	35	30	24	18
5360	13	6	0	-5	-9	-12	-17	-21	-22	-23
5370	-24	-22	-22	-22	-20	-17	-14	-12	-11	-10
5380	-8	-6	-6	-6	-4	-4	-3	-1	-1	-2
5390	-2	-3	-5	-7	-10	-11	-12	-14	-16	-18
5400	-21	-22	-22	-24	-26	-28	-31	-33	-36	-41
5410	-45	-49	-53	-57	-60	-62	-64	-65	-66	-66
5420	-66	-65	-64	-63	-61	-57	-54	-50	-44	-37
5430	-31	-24	-18	-14	-8	0	5	10	14	16
5440	16	16	17	17	16	15	15	12	11	11
5450	10	10	8	6	5	4	3	2	4	5
5460	5	5	6	7	8	7	7	6	7	7
5470	7	6	7	7	6	6	8	10	10	10
5480	10	11	13	13	13	13	13	11	10	10
5490	10	8	7	6	4	3	3	3	0	0
5500	-2	-3	-3	-3	-4	-5	-6	-8	-9	-13
5510	-15	-18	-20	-22	-24	-26	-26	-27	-27	-27
5520	-27	-26	-24	-23	-23	-21	-19	-17	-16	-16
5530	-16	-16	-16	-17	-18	-19	-18	-20	-20	-19
5540	-18	-19	-19	-19	-19	-19	-18	-18	-16	-16
5550	-16	-15	-14	-13	-11	-10	-8	-8	-6	-6
5560	-6	-6	-6	-6	-8	-9	-10	-11	-13	-14
5570	-16	-18	-17	-18	-17	-17	-17	-17	-16	-16
5580	-16	-15	-13	-13	-12	-12	-11	-11	-8	-8
5590	-6	-4	-2	1	0	0	1	1	1	3
5600	6	8	11	16	18	18	17	18	17	16
5610	19	22	23	22	20	15	9	5	3	1
5620	1	0	-1	0	0	1	2	3	5	7
5630	9	11	12	13	15	16	16	16	16	16
5640	17	17	16	15	14	12	10	8	5	2
5650	-1	-4	-6	-9	-11	-14	-16	-19	-20	-22
5660	-23	-23	-23	-21	-20	-19	-20	-19	-19	-18
5670	-18	-18	-18	-19	-19	-19	-19	-19	-21	-21
5680	-21	-19	-18	-17	-15	-14	-13	-11	-11	-10
5690	-9	-9	-9	-8	-9	-10	-11	-12	-14	-14
5700	-15	-17	-18	-17	-15	-14	-13	-11	-8	-6
5710	-3	-1	1	3	3	4	5	5	7	9
5720	10	10	12	15	16	17	17	18	19	21
5730	21	21	21	21	21	21	22	22	23	25
5740	27	27	27	26	24	23	22	20	17	15
5750	11	7	3	1	-1	-3	-3	-6	-7	-8
5760	-8	-8	-10	-12	-13	-15	-18	-18	-19	-19
5770	-19	-19	-19	-19	-20	-20	-19	-19	-19	-19
5780	-19	-18	-17	-14	-12	-10	-8	-8	-6	-4
5790	-2	-1	-1	-3	-3	-3	-3	-3	-5	-6
5800	-8	-9	-9	-10	-12	-13	-15	-14	-15	-15
5810	-13	-13	-13	-13	-13	-13	-13	-13	-12	-12
5820	-12	-12	-12	-12	-12	-12	-9	-11	-9	-9
5830	-8	-8	-8	-8	-8	-8	-8	-7	-4	0
5840	3	8	12	15	19	21	24	28	33	35
5850	36	37	37	37	35	34	33	32	28	25
5860	22	18	13	9	6	3	1	0	-2	-3
5870	-4	-4	-7	-9	-11	-14	-17	-19	-20	-22
5880	-25	-26	-29	-31	-32	-34	-35	-36	-37	-37

TO BE CONTINUED

CONTINUED(S-2107 DOWN)

NO.	(1)	(2)	(3)	(4)	(5)	(6)	(7)	(8)	(9)	(10)
5890	-37	-36	-34	-34	-33	-32	-32	-31	-27	-24
5900	-23	-20	-19	-18	-17	-15	-14	-14	-14	-14
5910	-12	-12	-12	-10	-9	-8	-8	-7	-7	-8
5920	-8	-8	-6	-6	-7	-8	-9	-9	-9	-10
5930	-11	-12	-10	-9	-9	-8	-9	-9	-8	-7
5940	0	0	-4	-4	-4	-4	-3	0	0	0
5950	0	0	0	0	0	0	0	1	2	4
5960	7	8	8	8	7	6	7	8	9	9
5970	8	7	8	7	8	7	8	9	9	9
5980	5	4	4	2	2	1	0	-2	-2	-3
5990	-3	-4	-4	-1	0	1	1	1	1	5

END

RECORD = S-2110 COMPONENT = SOUTH STATION = KASHIMA-ZOKAN-S
 DATE AND TIME = 1987-12-17-11-08 TOTAL NUMBER OF DATA = 6000
 SAMPLING INTERVAL = 0.010 (SEC) SIGNAL = GR. ACC.
 CONNECTION POINT IN DATA NUMBER = 3040, 6000,

CONTINUED(S-2110 SOUTH)										
NO.	(1)	(2)	(3)	(4)	(5)	(6)	(7)	(8)	(9)	(10)
490	-157	-171	-168	-168	-106	-52	0	50	103	155
500	182	194	203	206	206	194	161	124	87	56
510	29	-7	-49	-85	-104	-107	-95	-68	-35	-13
520	-1	13	28	36	38	27	-4	-56	-103	-127
530	-135	-135	-127	-109	-88	-63	-36	-18	-14	-14
540	-13	-3	12	22	22	7	-15	-31	-39	-39
550	-32	-14	5	20	32	35	28	8	-26	-66
560	-95	-106	-100	-71	-27	-7	-17	-42	-53	-53
570	-49	-27	7	24	20	-7	-87	-126	-136	-130
580	-103	-63	-35	-24	-19	-12	7	33	53	63
590	63	46	4	-82	-67	-81	-82	-72	-60	-44
600	-25	-3	20	35	39	37	35	37	56	86
610	106	112	103	76	29	-25	-72	-95	-103	-105
620	-103	-98	-90	-71	-38	3	47	76	86	85
630	70	55	47	44	44	44	42	29	2	-27
640	-43	-42	-17	31	86	128	141	135	112	73
650	28	-12	-44	-60	-74	-86	-97	-100	-84	-32
660	30	59	57	28	-2	-7	17	116	235	273
670	252	193	125	54	-29	-79	-102	-121	-145	-140
680	-166	-161	-137	-107	-78	-62	-56	-54	-38	12
690	71	110	121	105	78	70	105	172	258	260
700	263	220	140	64	9	-26	-44	-48	-44	-29
710	-7	15	31	36	35	28	16	1	-12	-19
720	-18	-13	-3	6	9	5	9	-32	-44	-31
730	5	44	81	116	129	99	45	-28	-108	-179
740	-209	-214	-207	-183	-139	-80	-22	27	73	97
750	101	85	46	17	21	78	123	137	132	132
760	100	60	31	10	-6	-21	-28	-52	-54	-54
770	-98	-20	-7	4	14	25	41	65	93	120
780	136	152	103	60	11	-41	-89	-117	-128	-132
790	-133	-133	-121	-77	-8	80	174	224	220	176
800	98	1	-75	-108	-117	-117	-110	-89	-49	-1
810	48	93	113	112	90	53	12	-28	-61	-19
820	25	54	70	70	44	-2	-38	-47	-39	-7
830	38	57	54	32	-2	-39	77	32	1	-19
840	-71	18	73	99	99	77	32	1	-14	-19
850	-8	8	25	33	35	33	27	19	10	0
860	-6	-12	-16	-12	1	21	33	36	32	18
870	-9	-40	-60	-70	-73	-72	-69	-65	-60	-52
880	15	64	38	55	54	32	42	34	-64	-28
890	-29	6	87	90	76	42	1	-34	-55	-58
900	-57	-53	-47	-42	-37	-34	-31	-31	-40	-64
910	-89	-99	-90	-44	50	93	113	111	80	21
920	-22	-64	-109	-143	-159	-161	-142	-88	-29	25
930	72	92	93	76	41	4	-20	-27	22	12
940	-1	6	10	9	0	-15	-23	-17	21	73
950	110	127	115	55	-32	-121	-193	-227	-235	-229
960	-215	-201	-191	-180	-165	-149	-136	-128	-126	-130
970	-139	-150	-159	-163	-160	-149	-135	-124	-118	-116
980	-120	-126	-132	-137	-142	-146	-149	-150	-147	-139
990	-126	-113	-95	-62	0	90	200	325	430	506
1000	554	576	584	583	570	541	492	338	249	249
1010	194	155	117	99	87	70	28	-25	-77	-124
1020	-161	-178	-184	-180	-170	-150	-117	-77	-53	-15

TO BE CONTINUED

CONTINUED (S-2110 SOUTH)

NO.	(1)	(2)	(3)	(4)	(5)	(6)	(7)	(8)	(9)	(10)	(11)	(12)	(13)	(14)	(15)	(16)	(17)	(18)	(19)	(20)	
1030	54	86	107	118	133	151	176	200	206	186	1570	400	369	335	298	260	225	184	125	57	111
1040	149	118	106	112	147	201	251	287	310	330	1580	-77	-134	-171	-185	-190	-192	-194	-207	-237	-287
1050	359	407	470	525	543	543	564	469	406	345	1590	-362	-433	-486	-527	-547	-553	-550	-540	-523	-496
1060	292	243	197	151	103	45	-22	-104	-424	-284	1600	-59	-409	-347	-275	-192	-96	-1	93	162	199
1070	358	400	414	415	406	-393	-384	-388	-432	-495	1610	214	219	283	238	234	272	285	292	294	293
1080	577	665	773	883	953	889	894	894	894	771	1620	288	284	282	279	277	275	272	268	267	267
1090	619	648	784	906	1000	1110	1220	1210	1185	1115	1630	262	240	206	158	100	36	-33	-105	-181	-258
1100	49	-19	-29	-83	-126	-141	-116	-116	-116	258	1640	325	393	438	463	466	448	396	327	248	-173
1110	347	367	364	340	303	278	270	272	289	323	1650	125	117	142	213	350	-42	-500	-536	-541	-532
1120	381	453	536	619	650	651	548	399	216	43	1660	-605	-448	-358	-242	-103	66	198	286	343	372
1130	-88	-104	-83	0	100	152	159	159	70	5	1670	377	369	359	352	346	359	317	274	224	171
1140	-85	-146	-174	-191	-222	-278	-353	-459	-526	-593	1680	127	98	88	84	81	70	33	25	-96	-174
1150	-631	-645	-689	-689	-646	-546	-416	-356	-303	-249	1690	-266	-355	-428	-474	-502	-514	-507	-478	-429	-377
1160	-187	-120	-41	44	122	198	269	332	361	390	1700	-317	-242	-162	-86	-13	53	93	107	112	109
1170	395	379	338	280	222	159	98	39	-15	-67	1710	94	63	20	-8	2	-98	-108	-109	-103	-93
1180	-109	-121	-85	35	195	392	612	804	871	859	1720	-75	-52	-23	8	42	73	98	118	130	137
1190	789	660	503	325	103	-156	-357	-516	-586	-610	1730	143	148	150	146	133	106	69	31	5	-7
1200	-588	-544	-498	-479	-478	-478	-468	-404	-276	-135	1740	-4	21	74	140	204	262	313	355	390	422
1210	-47	14	19	-22	-90	-144	-168	-168	-133	-79	1750	449	472	490	498	486	449	394	328	257	190
1220	-8	66	142	216	284	348	409	468	519	538	1760	128	78	53	40	31	19	5	-7	-24	-52
1230	579	575	531	455	362	257	163	115	107	109	1770	-79	-95	-100	-91	-73	-31	-42	-37	-43	-61
1240	110	93	21	-131	-296	-389	-408	-361	-234	-139	1780	-83	-101	-120	-142	-167	-200	-247	-305	-357	-396
1250	139	181	177	144	87	41	3	35	33	39	1790	-619	-424	-413	-377	-326	-277	-237	-189	-151	-134
1260	-220	-308	-351	-353	-295	-160	18	237	388	447	1800	-129	-137	-155	-170	-167	-154	-134	-109	79	163
1270	445	404	329	250	221	227	275	359	414	433	1810	239	292	328	350	359	360	352	343	336	332
1280	421	354	203	36	-159	-392	-507	-545	-440	-440	1820	331	331	331	325	305	279	253	232	218	209
1290	-267	-72	122	250	288	275	209	102	-17	104	1830	204	199	196	187	169	144	114	77	33	-8
1300	-139	-141	-119	-84	-48	-9	36	91	154	222	1840	-44	-65	-73	-72	-64	-52	-40	-24	0	24
1310	290	342	360	350	316	267	202	137	104	100	1850	55	95	131	169	204	232	252	267	273	272
1320	115	152	196	233	261	278	285	289	290	282	1860	255	205	166	98	57	27	13	12	18	29
1330	247	179	95	-6	-130	-261	-387	-450	-538	-561	1870	37	41	40	37	30	22	13	2	-17	-49
1340	-556	-492	-359	-158	141	362	426	434	402	354	1880	-92	-138	-191	-247	-296	-323	-331	-329	-317	-293
1350	217	118	47	11	-2	8	73	184	308	401	1890	-261	-334	-419	-515	-566	-622	-673	-726	-779	-828
1360	427	418	365	248	122	19	-29	-36	-20	-5	1900	-338	-345	-350	-348	-341	-341	-338	-308	-285	-263
1370	-9	-57	-144	-255	-383	-478	-520	-574	-457	-334	1910	-240	-221	-205	-190	-174	-155	-136	-116	-105	-109
1380	-195	-55	67	154	201	220	222	205	133	107	1920	-127	-153	-188	-228	-253	-258	-248	-228	-201	-169
1390	52	-5	-66	-128	-179	-224	-262	-284	-283	-255	1930	-131	-91	-52	-15	16	35	42	46	45	40
1400	-207	-151	-104	-88	-92	-114	-148	-172	-179	-170	1940	36	37	51	77	113	146	170	188	195	188
1410	-144	-117	-91	-71	-46	-15	7	20	13	-15	1950	181	176	178	196	220	242	258	262	255	239
1420	-57	-93	-105	-95	-57	0	56	107	126	119	1960	216	191	167	145	122	100	76	48	15	-21
1430	88	48	10	-8	-11	7	51	84	95	86	1970	-58	-91	-115	-129	-131	-120	-90	-43	12	73
1440	47	3	-25	-31	-18	0	20	42	61	75	1980	131	174	198	209	208	198	183	165	139	100
1450	89	115	160	220	287	342	360	357	352	251	2000	-278	-262	-238	-204	-161	-124	-88	-61	-58	-70
1460	168	86	15	-57	-124	-174	-206	-251	-285	-221	2010	-45	-33	-19	-2	10	22	31	44	58	70
1470	-213	-208	-204	-199	-187	-146	-76	-5	49	81	2020	84	101	117	130	135	139	140	141	144	148
1480	84	60	9	-60	-144	-230	-308	-370	-410	-426	2030	153	156	156	156	156	156	156	156	157	156
1490	-397	-302	-164	-27	76	144	155	110	28	-33	2040	136	108	67	22	-22	-58	-80	-88	-86	-80
1500	-119	-218	-290	-331	-332	-290	-201	-89	42	169	2050	-47	-17	8	32	55	71	78	79	74	59
1510	260	325	368	376	362	330	290	339	180	115	2060	30	-11	-58	-99	-129	-146	-153	-152	-138	-116
1520	36	14	-8	-17	-24	-29	-47	-93	-140	-187	2070	-90	-63	-38	-20	-11	-7	-6	-7	-6	-6
1530	-240	-284	-302	-305	-297	-267	-207	-157	-64	2	2080	-5	0	7	12	18	26	38	51	64	79
1540	35	30	3	-21	-31	-23	-4	32	69	92	2090	97	116	130	141	145	144	134	113	82	53
1550	102	107	109	109	108	108	116	136	170	218	2100	20	-19	-46	-56	-55	-49	-38	-26	-17	-12
1560	271	320	359	390	415	435	448	452	447	428	2110	20	-19	-46	-56	-55	-49	-38	-26	-17	-12

TO BE CONTINUED

NO.	(1)	(2)	(3)	(4)	(5)	(6)	(7)	(8)	(9)	(10)	(11)	(12)	(13)	(14)	(15)	(16)	(17)	(18)	(19)	(20)
2110	-10	-2	18	51	89	122	137	140	129	100	2650	-18	-24	-28	-33	-40	-45	-48	-48	-47
2120	71	49	32	21	16	17	20	21	21	16	2660	-44	-40	-37	-36	-32	-28	-24	-19	-12
2130	10	2	-7	-23	-41	-57	-72	-89	-106	-121	2670	-2	10	27	44	62	79	92	102	106
2140	-43	-141	-146	-143	-128	-104	-79	-61	-49	122	2680	93	90	80	71	63	55	56	63	77
2150	-42	-37	-33	-24	8	36	64	94	122	144	2690	89	102	114	125	136	144	148	149	144
2160	147	167	186	206	223	233	236	233	218	194	2700	119	104	89	77	68	61	57	56	64
2170	162	126	89	58	28	2	-24	-50	-71	-87	2710	72	83	90	95	98	88	76	62	49
2180	-103	-116	-130	-142	-155	-175	-197	-219	-236	-246	2720	38	29	19	8	-2	-12	-23	-38	-55
2190	-250	-246	-233	-210	-175	-130	-80	-24	25	71	2730	-89	-107	-122	-134	-145	-152	-155	-155	-152
2200	115	159	196	216	220	216	203	180	165	154	2740	-149	-146	-142	-139	-137	-134	-127	-124	-120
2210	145	135	119	94	67	44	28	18	13	13	2750	-117	-114	-110	-106	-100	-93	-85	-76	-61
2220	18	28	38	46	51	49	35	12	-17	-52	2760	-13	32	39	58	69	73	72	70	66
2230	-85	-110	-124	-130	-150	-126	-120	-114	-108	-103	2770	61	57	51	46	41	39	39	40	40
2240	95	-82	-65	-45	-22	2	14	29	42	57	2780	42	43	41	41	42	47	52	54	54
2250	68	77	83	85	83	76	68	57	46	38	2790	52	46	39	26	11	-2	-15	-20	-22
2260	27	12	-6	-31	-58	-86	-108	-123	-133	-142	2800	-21	-19	-19	-18	-18	-18	-16	-14	-12
2270	-155	-171	-193	-218	-246	-266	-275	-276	-264	-243	2810	-11	-12	-13	-15	-18	-25	-36	-45	-50
2280	-221	-196	-178	-164	-157	-154	-155	-155	-155	-155	2820	-53	-52	-48	-41	-33	-27	-23	-21	-23
2290	-154	-153	-153	-154	-155	-157	-158	-158	-157	-155	2830	-56	-56	-66	-76	-87	-99	-109	-115	-118
2300	-151	-147	-141	-135	-129	-127	-127	-130	-136	-143	2840	-120	-119	-116	-109	-100	-87	-71	-58	-41
2310	-151	-157	-162	-162	-159	-153	-143	-129	-111	-89	2850	-37	-36	-35	-38	-42	-45	-50	-62	-68
2320	-61	-32	-1	30	61	89	120	154	187	224	2860	-73	-78	-79	-82	-85	-89	-91	-96	-97
2330	259	287	307	319	325	328	324	312	294	273	2870	50	72	90	109	125	138	147	152	156
2340	252	232	213	197	186	181	182	188	196	204	2880	158	159	159	160	162	164	165	166	163
2350	208	209	199	174	131	65	33	1	-65	-132	2890	158	151	145	139	134	129	126	124	125
2360	-187	-231	-257	-264	-257	-252	-193	-149	-96	-6	2900	133	139	148	159	171	179	182	181	174
2370	16	58	80	88	80	61	38	14	-11	-33	2910	131	93	47	3	-8	-56	-78	-91	-96
2380	-45	-49	-49	-43	-29	-8	17	44	67	83	2920	-94	-89	-81	-71	-62	-55	-51	-47	-45
2390	91	93	88	79	72	68	70	75	81	88	2930	-46	-50	-55	-64	-76	-88	-99	-112	-126
2400	91	90	87	83	79	72	62	47	26	-1	2940	-155	-166	-173	-177	-177	-173	-163	-149	-139
2410	-28	-48	-63	-75	-82	-89	-94	-98	-97	-94	2950	-86	-88	-84	-82	-82	-82	-83	-82	-80
2420	-86	-72	-55	-40	-27	-15	8	0	6	13	2960	44	32	61	72	86	104	128	149	172
2430	24	35	41	48	50	47	38	24	5	-11	2970	209	219	223	221	211	170	152	137	124
2440	-24	-32	-36	-38	-34	-28	-19	-5	13	13	2980	114	106	100	97	95	91	84	70	49
2450	38	66	89	101	106	104	98	89	80	68	2990	-7	-47	-90	-125	-145	-158	-170	-186	-189
2460	49	24	0	-22	-40	-50	-53	-51	-49	-46	3000	-190	-190	-187	-181	-171	-160	-148	-138	-128
2470	-44	-41	-33	-16	4	24	41	52	59	63	3010	-123	-118	-116	-112	-102	-99	-97	-96	-96
2480	65	65	64	64	66	69	72	75	70	82	3020	-96	-95	-88	-88	-77	-62	-46	-28	-11
2490	85	86	86	84	79	73	67	61	57	49	3030	-22	37	53	68	77	83	87	90	91
2500	42	35	21	4	-8	-21	-37	-60	-80	-91	3040	90	88	87	85	82	78	73	68	59
2510	-100	-116	-133	-149	-155	-157	-159	-159	-157	-155	3050	34	24	16	5	-8	-23	-36	-43	-47
2520	-154	-171	-143	-131	-111	-87	-60	-36	-6	26	3060	-50	-50	-50	-48	-48	-52	-65	-79	-94
2530	52	71	86	94	100	102	104	103	99	98	3070	-118	-126	-131	-131	-129	-123	-113	-101	-89
2540	96	94	92	87	81	75	70	69	72	83	3080	-67	-55	-42	-28	-13	2	15	29	41
2550	96	115	135	153	167	176	183	187	187	181	3090	66	74	81	87	92	93	88	82	71
2560	168	149	132	117	103	91	81	72	63	54	3100	57	41	24	7	-8	-18	-23	-24	-17
2570	45	34	28	22	14	3	-8	-24	-44	-67	3110	-6	5	17	30	41	52	60	66	70
2580	-89	-110	-128	-145	-156	-162	-164	-164	-160	-152	3120	70	65	57	48	40	33	28	26	29
2590	-142	-132	-127	-125	-126	-125	-125	-125	-116	-107	3130	44	53	60	64	64	59	51	40	25
2600	-98	-94	-93	-94	-98	-106	-114	-122	-125	-124	3140	-10	-32	-52	-68	-82	-93	-104	-104	-108
2610	-116	-105	-91	-70	-49	-33	-24	-17	-13	-10	3150	-107	-104	-100	-95	-89	-84	-79	-75	-71
2620	-9	-10	-11	-12	-17	-24	-33	-44	-58	-73	3160	-63	-57	-50	-41	-32	-21	-10	1	12
2630	-85	-90	-92	-88	-77	-60	-40	-25	-18	-16	3170	30	39	49	60	69	77	84	88	87
2640	-14	-13	-12	-10	-7	-6	-8	-11	-13	-15	3180	75	64	55	46	40	37	32	29	32

TO BE CONTINUED

TO BE CONTINUED

NO.	(1)	(2)	(3)	(4)	(5)	(6)	(7)	(8)	(9)	(10)	NO.	(1)	(2)	(3)	(4)	(5)	(6)	(7)	(8)	(9)	(10)
3190	44	50	55	60	64	69	71	71	69	62	3730	30	25	22	19	16	15	15	16	15	14
3200	54	37	22	7	-4	-17	-37	-36	-44	52	3740	14	14	15	15	15	15	15	16	15	14
3210	-59	-65	-69	-75	-82	-87	-92	-94	-93	-90	3750	10	3	-6	-18	-28	-37	-44	-49	-52	-53
3220	84	73	55	32	5	22	66	84	84	98	3760	-51	-50	-47	-45	-46	-48	-50	-54	-59	-63
3230	108	113	116	119	121	123	124	124	123	121	3770	-66	-67	-69	-71	-73	-73	-71	-65	-60	-57
3240	119	117	115	114	112	111	110	109	107	104	3780	-52	-48	-43	-40	-38	-38	-38	-35	-33	-31
3250	99	90	75	57	41	23	1	-32	-40	-56	3790	-26	-19	-16	-11	-6	-3	-1	0	2	7
3260	-73	-89	-100	-105	-110	-114	-117	-116	-113	-108	3800	12	16	21	26	33	42	50	62	74	89
3270	-103	-95	-87	-81	-77	-73	-67	-61	-51	-40	3810	101	114	128	137	143	144	142	138	136	133
3280	-28	-18	-8	-1	2	6	2	0	-6	-15	3820	128	120	117	112	103	91	76	62	48	33
3290	-24	-34	-43	-52	-58	-63	-68	-70	-70	-67	3830	20	8	-1	-8	-14	-18	-23	-28	-31	-32
3300	-65	-57	-51	-45	-39	-35	-33	-32	-29	-24	3840	-32	-32	-32	-34	-38	-43	-47	-52	-56	-62
3310	-18	-10	-11	-15	-19	-22	-24	-24	-24	-24	3850	-67	-72	-76	-80	-81	-81	-80	-79	-75	-68
3320	-24	-24	-21	-16	-10	-1	10	25	44	66	3860	-59	-42	-33	-25	-17	-9	0	8	18	18
3330	87	108	130	152	170	177	178	176	171	165	3870	30	41	54	62	67	71	75	77	76	75
3340	159	154	149	143	137	132	129	125	123	120	3880	71	65	61	57	48	39	29	21	15	6
3350	117	112	107	102	94	73	52	37	22	3	3890	-5	-18	-31	-45	-58	-72	-84	-93	-101	-106
3360	-15	-30	-41	-50	-57	-67	-74	-80	-87	-94	3900	-108	-108	-108	-108	-107	-106	-104	-101	-96	-92
3370	-99	-104	-108	-115	-126	-140	-153	-162	-169	-173	3910	-89	-85	-80	-74	-66	-57	-46	-34	-23	-10
3380	-173	-172	-168	-166	-161	-152	-138	-121	-102	-85	3920	3	16	30	44	55	66	73	78	80	82
3390	-67	-46	-22	0	18	36	51	62	72	78	3930	84	84	84	84	84	85	85	85	85	81
3400	83	89	97	103	108	113	115	116	115	112	3940	78	74	69	64	60	53	43	32	20	9
3410	107	101	91	80	69	56	43	32	24	18	3950	-6	-15	-27	-41	-53	-68	-79	-88	-93	-97
3420	14	14	14	13	12	11	11	10	10	10	3960	-99	-98	-93	-87	-82	-75	-70	-62	-51	-42
3430	10	15	17	23	29	37	48	56	60	62	3970	-35	-31	-27	-25	-18	-13	-9	-3	4	11
3440	64	63	61	58	54	48	43	38	36	33	3980	16	23	30	37	45	53	61	69	77	85
3450	21	29	27	25	21	15	11	6	-3	-15	3990	92	99	105	110	114	115	118	121	122	118
3460	-26	-35	-45	-52	-56	-58	-58	-57	-53	-49	4000	113	109	103	97	92	85	77	68	57	48
3470	-4	-41	-39	-38	-38	-42	-46	-48	-49	-51	4010	40	33	28	25	21	17	14	12	9	8
3480	-53	-52	-53	-53	-53	-53	-52	-48	-41	-35	4020	6	3	0	-2	-6	-11	-15	-21	-27	-32
3490	-28	-22	-14	-4	6	19	32	43	51	55	4030	-37	-42	-46	-47	-48	-48	-49	-51	-52	-53
3500	59	62	61	58	55	51	47	44	43	44	4040	-54	-55	-55	-55	-54	-54	-53	-53	-53	-53
3510	43	40	38	37	34	29	23	18	14	11	4050	-53	-53	-52	-50	-46	-44	-42	-37	-32	-29
3520	6	2	0	-2	-6	-6	-4	0	8	15	4060	-22	-13	-2	6	13	18	23	28	32	35
3530	25	36	45	50	54	54	49	41	33	20	4070	39	43	45	47	50	55	58	61	62	62
3540	10	1	-7	-15	-19	-20	-22	-23	-23	-25	4080	59	54	45	34	21	8	-1	-19	-28	-28
3550	-29	-33	-36	-40	-41	-42	-40	-40	-40	-40	4090	-37	-45	-53	-60	-68	-72	-77	-82	-87	-90
3560	-41	-44	-48	-52	-55	-58	-61	-63	-64	-65	4100	-91	-92	-93	-94	-95	-96	-96	-95	-92	-89
3570	-65	-66	-59	-47	-40	-37	-35	-32	-27	-18	4110	-84	-75	-65	-54	-46	-38	-31	-25	-20	-18
3580	-7	5	18	32	46	58	67	74	81	84	4120	-17	-17	-18	-19	-23	-23	-22	-21	-19	-16
3590	84	83	81	77	71	67	64	60	56	53	4130	-11	-7	-1	8	15	22	29	35	41	46
3600	50	46	43	42	41	41	43	45	44	42	4140	51	54	57	58	59	59	61	62	62	63
3610	38	34	29	22	14	7	-2	-12	-19	-25	4150	64	64	63	61	57	53	46	37	35	33
3620	-32	-37	-42	-43	-45	-48	-47	-48	-48	-49	4160	30	29	28	27	27	25	23	18	13	7
3630	-48	-47	-45	-44	-45	-41	-39	-38	-35	-32	4170	0	-8	-15	-24	-33	-42	-49	-53	-56	-58
3640	-13	-3	6	12	14	15	14	13	10	7	4180	-59	-57	-55	-52	-50	-47	-45	-43	-43	-43
3650	4	3	1	0	0	0	2	3	4	4	4190	-46	-47	-48	-49	-48	-45	-41	-36	-31	-26
3660	28	35	42	50	58	66	73	78	83	88	4200	-21	-18	-14	-10	-8	-8	-7	-8	-9	-8
3670	91	93	94	93	90	87	81	76	73	68	4210	67	69	69	69	66	63	58	53	47	40
3680	71	70	70	70	70	71	71	72	69	62	4220	67	69	69	69	66	63	58	53	47	40
3690	53	43	29	16	-9	-22	-35	-47	-58	-73	4230	35	32	30	29	29	29	29	30	28	26
3700	-66	-72	-77	-79	-78	-75	-73	-74	-73	-73	4240	22	19	16	13	11	8	6	5	7	11
3710	-76	-79	-80	-82	-82	-80	-73	-65	-55	-42	4250	17	24	32	40	48	52	55	57	58	60
3720	-31	-21	-9	5	16	24	30	34	37	36	4260	62	63	64	65	66	66	67	66	66	64

TO BE CONTINUED

TO BE CONTINUED

CONTINUED (S-2110 SOUTH)

CONTINUED (S-2110 SOUTH)

NO.	(1)	(2)	(3)	(4)	(5)	(6)	(7)	(8)	(9)	(10)
4270	63	62	59	57	55	54	53	51	51	48
4280	47	46	45	43	42	41	38	33	28	23
4290	17	8	0	-4	-12	-17	-23	-28	-32	-34
4300	-37	-40	-43	-45	-49	-51	-55	-58	-63	-68
4310	-72	-76	-81	-86	-90	-92	-95	-95	-94	-94
4320	-90	-87	-81	-75	-71	-65	-58	-49	-41	-34
4330	-25	-18	-9	-1	5	12	17	20	22	24
4340	24	25	25	27	30	32	36	39	43	43
4350	48	52	61	63	65	66	66	66	65	65
4360	67	67	66	64	62	61	60	57	52	47
4370	43	39	33	31	28	23	18	14	14	7
4380	1	-50	-54	-57	-60	-63	-67	-71	-76	-80
4390	-46	-61	-67	-71	-75	-81	-88	-95	-101	-107
4400	-87	-89	-89	-88	-88	-88	-88	-85	-81	-75
4410	-66	-61	-55	-51	-47	-45	-43	-40	-39	-36
4420	-34	-32	-32	-32	-32	-31	-29	-27	-26	-23
4430	-20	-19	-17	-13	-9	-5	0	5	10	13
4440	15	16	16	14	14	14	14	14	15	18
4450	24	27	29	34	39	42	44	45	47	50
4460	51	50	51	51	53	55	56	57	61	63
4470	88	72	76	81	82	83	84	85	86	85
4480	86	85	84	82	78	74	65	54	43	35
4490	26	19	10	0	-8	-15	-23	-30	-36	-40
4500	-44	-47	-48	-48	-48	-49	-51	-55	-57	-59
4510	-60	-60	-59	-55	-51	-46	-41	-35	-28	-23
4520	-18	-15	-13	-11	-10	-9	-7	-5	-4	-2
4530	0	0	-1	-2	-2	-3	-4	-5	-6	-9
4540	-12	-11	-14	-17	-13	-9	-7	-5	-4	-4
4550	-4	-4	-2	-3	-5	-11	-16	-20	-25	-31
4560	-35	-37	-38	-39	-40	-42	-43	-41	-40	-38
4570	-37	-35	-32	-31	-28	-24	-21	-18	-12	-4
4580	2	8	12	15	18	20	18	15	10	4
4590	-4	-15	-26	-34	-44	-56	-63	-69	-75	-82
4600	-87	-91	-94	-96	-96	-95	-94	-92	-88	-83
4610	-76	-68	-60	-51	-42	-36	-31	-26	-20	-13
4620	-7	-3	0	7	12	14	19	24	29	31
4630	34	35	35	34	30	29	27	26	26	24
4640	15	14	15	17	16	18	21	27	32	35
4650	37	38	41	45	49	52	58	62	67	71
4660	76	79	81	81	79	77	72	65	59	54
4670	48	42	38	34	28	23	19	15	9	2
4680	-5	-12	-12	-11	-10	-9	-8	-7	-6	-5
4690	-22	-19	-16	-13	-10	-6	-5	-3	0	1
4700	3	6	10	12	14	18	21	24	24	29
4710	32	34	35	36	36	36	36	35	31	26
4720	22	21	18	14	10	6	3	0	-4	-6
4730	-9	-11	-13	-14	-15	-17	-20	-22	-24	-25
4740	-25	-27	-29	-30	-31	-31	-29	-26	-23	-19
4750	-15	-10	-6	-1	4	11	16	20	25	31
4760	38	46	54	59	63	66	69	72	74	74
4770	75	76	75	74	73	72	70	69	68	65
4780	63	60	58	55	50	42	35	26	17	6
4790	0	-7	-13	-18	-25	-31	-36	-41	-46	-52
4800	-57	-65	-67	-73	-77	-79	-82	-82	-83	-84

TO BE CONTINUED

TO BE CONTINUED

CONTINUED(S-2110 SOUTH)

NO.	(1)	(2)	(3)	(4)	(5)	(6)	(7)	(8)	(9)	(10)
5350	-53	-50	-47	-47	-46	-42	-38	-34	-28	-23
5360	-18	-12	-7	-3	0	3	9	13	15	18
5370	32	26	29	30	32	35	36	35	34	34
5380	35	36	36	36	37	37	36	36	35	35
5390	29	27	28	31	32	32	31	33	31	28
5400	26	26	27	27	25	24	23	20	18	18
5410	16	15	13	9	5	2	0	0	-2	-5
5420	-8	-10	-15	-18	-21	-25	-28	-29	-29	-29
5430	-30	-29	-27	-25	-24	-22	-21	-20	-21	-22
5440	-22	-24	-25	-24	-22	-20	-20	-18	-16	-15
5450	-12	-7	-4	-4	-3	-1	1	2	0	0
5460	1	-1	-2	-3	-2	0	0	0	0	0
5470	0	1	5	10	14	20	22	21	21	21
5480	22	22	25	29	33	37	38	40	45	49
5490	51	51	54	57	58	59	57	55	52	48
5500	43	37	33	29	23	17	12	6	1	-1
5510	-5	-8	-9	-11	-14	-17	-17	-15	-13	-11
5520	-10	-9	-9	-8	-7	-6	-4	-3	-3	-5
5530	-5	-5	-5	-5	-6	-7	-9	-11	-11	-7
5540	-5	-3	-2	0	4	9	11	12	12	11
5550	10	10	11	8	6	5	5	5	5	6
5560	5	1	-3	-5	-10	-14	-18	-22	-27	-31
5570	-37	-44	-50	-54	-59	-67	-71	-74	-75	-78
5580	-80	-80	-80	-79	-76	-73	-68	-61	-53	-46
5590	-39	-31	-23	-16	-9	-3	3	9	12	16
5600	20	25	30	37	43	46	49	53	55	57
5610	58	60	59	57	57	56	56	54	51	51
5620	46	43	39	35	31	29	28	24	21	20
5630	21	21	20	20	20	17	13	8	3	0
5640	0	-1	-2	-4	-5	-10	-13	-15	-18	-20
5650	-22	-23	-26	-29	-31	-36	-42	-47	-50	-53
5660	-7	-61	-65	-63	-63	-63	-61	-58	-55	-52
5670	-46	-41	-38	-34	-31	-29	-27	-24	-22	-20
5680	-19	-15	-11	-8	-5	-3	0	0	0	2
5690	4	4	2	0	0	-1	-3	-2	0	1
5700	3	6	8	12	15	18	20	23	24	25
5710	26	26	25	25	25	25	25	24	22	19
5720	19	19	19	19	20	20	18	16	11	7
5730	6	4	-3	-8	-13	-16	-20	-22	-24	-24
5740	-24	-24	-22	-23	-24	-23	-22	-21	-20	-20
5750	-20	-21	-21	-20	-18	-15	-12	-9	-6	-5
5760	-5	-4	0	3	5	7	11	14	17	20
5770	23	26	28	31	32	32	33	34	34	34
5780	34	33	32	31	30	29	28	27	27	24
5790	23	22	22	19	17	15	15	15	13	11
5800	10	10	7	7	7	7	6	6	6	7
5810	7	7	6	5	6	4	0	0	-3	-3
5820	-6	-10	-13	-14	-14	-16	-18	-18	-18	-18
5830	-18	-18	-17	-16	-15	-15	-15	-13	-10	-8
5840	-6	-5	-5	-5	-5	-5	-6	-7	-6	-4
5850	-3	-2	0	0	2	4	6	9	12	14
5860	15	17	17	17	17	16	15	15	14	14
5870	13	11	7	3	-1	-9	-15	-19	-22	-24
5880	-25	-26	-30	-32	-32	-32	-33	-34	-33	-30

TO BE CONTINUED

CONTINUED(S-2110 SOUTH)

NO.	(1)	(2)	(3)	(4)	(5)	(6)	(7)	(8)	(9)	(10)
5890	-28	-25	-23	-19	-17	-10	-5	-2	3	6
5900	10	13	16	19	24	27	29	34	38	41
5910	42	45	48	50	52	53	54	54	54	52
5920	48	46	43	41	36	33	30	28	27	27
5930	27	25	23	22	20	17	15	14	12	10
5940	6	2	-1	-5	-7	-10	-14	-19	-23	-25
5950	-28	-30	-32	-33	-33	-34	-34	-34	-34	-33
5960	-31	-28	-25	-24	-22	-19	-18	-15	-11	-8
5970	-5	0	4	7	10	12	15	16	17	19
5980	22	25	27	27	26	25	24	22	21	20
5990	18	18	21	22	21	21	23	25	22	20

END

RECORD = S-2110 COMPONENT = EAST STATION = KASHIMA-ZOKAN-S
 DATE AND TIME = 1987-12-17-11-08 TOTAL NUMBER OF DATA = 6000
 SAMPLING INTERVAL = 0.010 (SEC) SCAL = 0.10000
 SIGNAL = GR. ACC. CONNECTION POINT IN DATA NUMBER = 3042, 6000,

NO.	(1)	(2)	(3)	(4)	(5)	(6)	(7)	(8)	(9)	(10)
0	0	0	0	0	0	0	0	0	0	0
10	-2	-2	-2	-2	-2	-2	-2	-2	-2	-2
20	-2	-2	-2	-2	-2	-2	-2	-2	-2	-2
30	0	0	0	0	0	0	0	0	0	0
40	0	1	2	3	3	4	4	4	4	4
50	4	4	4	4	4	4	4	4	4	4
60	0	1	2	2	2	2	2	2	2	2
70	0	0	0	0	-3	-8	-12	-12	0	0
80	11	21	27	27	22	13	6	3	5	13
90	19	20	15	5	-7	-18	-25	-23	-4	13
100	23	23	11	-3	-14	-17	-14	-2	7	11
110	10	3	-8	-24	-34	-37	-27	-8	13	32
120	39	33	19	2	-8	-12	-7	0	10	17
130	20	15	7	0	-4	-5	-5	-5	-5	-5
140	-9	-11	-11	-5	2	14	24	25	18	6
150	-6	-16	-16	1	8	11	2	-13	-21	-23
160	-18	-6	7	18	23	19	7	-5	-1	6
170	-23	-17	-8	0	-33	-33	3	11	1	-23
180	10	12	10	1	-10	-19	-23	-23	-20	-17
190	-14	-12	-11	-9	-7	-6	-5	-5	-14	-23
200	-28	-25	-5	19	39	44	32	11	-4	-8
210	-1	7	9	4	-5	-9	0	23	49	72
220	83	77	54	27	4	-8	-12	-10	-4	0
230	0	0	1	3	5	5	2	0	-3	-2
240	3	10	18	24	26	23	17	10	2	-9
250	-19	-33	-35	-18	4	9	18	24	28	33
260	40	47	44	26	-2	-33	-57	-70	-73	-66
270	-42	-2	41	63	60	35	3	-15	-16	0
280	25	41	44	31	11	0	7	26	46	56
290	53	43	31	19	13	9	3	-6	-23	-41
300	-54	-57	-58	-38	-22	-22	-24	-24	-24	-24
310	-19	-11	-3	6	19	35	52	64	68	62
320	46	20	-7	-33	-54	-64	-58	-40	-4	35
330	55	64	61	54	46	59	34	24	12	12
340	3	-2	-5	0	8	16	22	19	8	-6
350	-24	-37	-40	-34	-20	-3	10	23	45	45
360	40	38	32	24	17	-61	-70	-25	35	43
370	36	11	-25	-59	-80	-83	-65	-32	-1	15
380	18	14	13	22	64	70	85	82	63	34
390	3	-23	-52	-77	-94	-102	-98	-85	-67	-50
400	-40	-51	-13	10	47	81	100	99	78	40
410	0	-34	-57	-72	-80	-81	-75	-58	-28	6
420	30	42	45	35	24	18	17	22	27	31
430	27	11	-9	-28	-41	-44	-42	-36	-28	-23
440	-19	-16	-14	-14	-15	-15	-13	-4	6	14
450	25	32	38	43	52	61	63	52	21	-21
460	-56	-68	-68	-59	-43	-33	-35	-49	-61	-57
470	-12	16	14	53	54	47	37	28	23	22
480	22	23	27	28	27	24	18	5	-13	-52
490	59	66	66	66	59	66	112	167	217	247

TO BE CONTINUED

TO BE CONTINUED

CONTINUED(S-2110 EAST)

NO.	(1)	(2)	(3)	(4)	(5)	(6)	(7)	(8)	(9)	(10)
1030	153	148	148	145	133	107	64	18	-16	-37
1040	-51	-62	-70	-77	-81	-82	-79	-74	-70	-70
1050	-72	-73	-67	-45	-4	43	87	118	138	150
1060	158	164	170	177	186	209	209	218	232	230
1070	208	189	167	148	132	118	103	84	57	18
1080	-32	-95	-161	-215	-248	-261	-247	-203	-157	-129
1090	-124	-142	-175	-214	-252	-287	-324	-357	-387	-403
1100	-399	-361	-283	-175	-48	51	100	106	91	74
1110	110	123	121	243	412	506	537	469	407	347
1120	290	217	132	39	-44	-124	-212	-319	-359	-329
1130	-311	-271	-214	-135	-34	63	147	216	256	238
1140	253	215	171	134	109	92	79	67	45	5
1150	-45	-90	-125	-152	-170	-194	-233	-292	-376	-468
1160	-557	-642	-698	-704	-636	-601	-574	-57	431	-607
1170	644	621	545	441	322	203	84	-9	-64	-47
1180	-20	60	194	352	470	531	547	531	489	425
1190	333	210	170	-86	-256	-415	-513	-527	-437	-248
1200	4	147	163	125	73	63	40	54	72	49
1210	17	-61	-204	-359	-447	-499	-477	-345	-178	17
1220	275	61	669	606	483	306	118	-53	-178	-247
1230	-264	-237	-176	-94	-9	38	42	21	-23	-93
1240	-159	-203	-222	-198	-134	-47	47	101	100	58
1250	-115	-118	-207	-268	-300	-282	-200	-222	-200	-200
1260	-173	-118	-13	125	232	290	295	262	207	106
1270	-66	-160	-239	-300	-313	-283	-226	-172	-149	-147
1280	-154	-157	-146	-114	-72	-59	-19	0	37	112
1290	234	351	409	412	362	279	188	101	32	-10
1300	-36	-57	-78	-96	-107	-107	-89	-43	24	100
1310	180	253	305	336	339	304	239	155	59	-34
1320	-87	-78	-24	58	137	178	177	136	63	-36
1330	-142	-215	-279	-341	-381	-397	-381	-318	-205	40
1340	151	271	311	312	295	269	245	216	173	106
1350	1	-102	-196	-264	-298	-296	-249	-150	-18	110
1360	223	301	340	341	304	242	165	57	-67	-150
1370	-186	-200	-208	-225	-269	-324	-369	-360	-293	-202
1380	-41	191	398	479	507	519	522	515	488	429
1390	349	252	143	33	-61	-139	-202	-244	-260	-258
1400	-239	-199	-137	-59	19	78	110	122	117	93
1410	48	-13	-75	-118	-145	-155	-145	-126	-105	-93
1420	-102	-131	-181	-233	-274	-289	-272	-236	-192	-156
1430	-144	-148	-157	-164	-169	-174	-179	-185	-196	-213
1440	-225	-230	-225	-210	-178	-131	-66	12	128	244
1450	359	490	575	614	615	584	530	468	409	363
1460	322	285	248	209	153	78	6	-49	-84	-99
1470	-98	-90	-80	-75	-77	-88	-105	-120	-131	-136
1480	-138	-139	-139	-136	-130	-119	-94	-40	50	189
1490	328	393	408	387	331	261	207	164	115	61
1500	2	-52	-75	-51	16	84	115	134	156	166
1510	164	156	144	129	116	98	70	24	-31	-101
1520	-176	-257	-344	-440	-458	-505	-538	-551	-555	-556
1530	-554	-542	-506	-445	-373	-297	-197	-41	121	196
1540	208	206	200	196	191	184	167	129	67	-12
1550	-105	-178	-222	-252	-272	-284	-293	-296	-287	-263
1560	-223	-167	-97	-32	5	23	26	18	0	-27

TO BE CONTINUED

CONTINUED(S-2110 EAST)

NO.	(1)	(2)	(3)	(4)	(5)	(6)	(7)	(8)	(9)	(10)
1570	-57	-82	-97	-101	-94	-77	-55	-35	-24	-18
1580	-16	-15	-15	-13	-12	-12	-17	-25	-34	-40
1590	-44	-47	-47	-46	-44	-38	-26	-7	9	30
1600	44	57	72	88	102	110	110	103	90	71
1610	54	67	69	71	114	161	204	228	242	252
1620	260	281	339	424	464	482	488	482	458	427
1630	390	358	267	177	90	0	-83	-162	-238	-300
1640	-348	-385	-409	-485	-432	-432	-422	-359	-371	-346
1650	-327	-314	-305	-297	-284	-252	-213	-151	-83	-33
1660	-6	11	27	46	78	129	182	212	223	220
1670	197	152	99	55	25	5	-5	-70	-73	-76
1680	-71	-56	-27	14	66	110	131	125	96	53
1690	18	0	0	18	57	104	133	146	151	153
1700	154	156	161	163	154	131	78	-15	-102	-170
1710	-230	-294	-353	-397	-425	-428	-394	-331	-243	-143
1720	-54	-2	23	40	60	89	130	177	218	247
1730	262	264	269	214	164	109	60	23	-1	-9
1740	-1	21	55	88	115	137	155	166	170	170
1750	163	148	126	103	90	85	82	81	81	76
1760	65	42	21	8	2	-3	-9	-27	-61	-106
1770	-165	-222	-269	-300	-323	-332	-325	-306	-273	-242
1780	-220	-209	-204	-202	-198	-174	-102	25	184	287
1790	337	347	333	301	257	204	157	125	106	101
1800	107	123	143	161	172	178	179	179	180	185
1810	192	198	196	180	147	101	50	1	-38	-66
1820	-85	-97	-114	-137	-163	-186	-203	-215	-219	-215
1830	-205	-181	-137	-80	-29	-2	6	1	-17	-50
1840	-77	-95	-104	-106	-99	-78	-44	9	91	146
1850	170	179	181	178	175	175	181	189	194	189
1860	175	160	148	143	145	154	164	169	169	156
1870	128	91	51	12	-18	-43	-68	-102	-139	-172
1880	-207	-241	-266	-287	-299	-307	-311	-308	-298	-278
1890	-243	-206	-173	-149	-136	-131	-131	-133	-138	-146
1900	-155	-169	-189	-217	-255	-301	-342	-365	-372	-371
1910	-360	-336	-307	-273	-240	-216	-202	-191	-183	-175
1920	-167	-156	-141	-123	-106	-85	-51	11	113	236
1930	372	510	607	634	640	630	607	572	523	459
1940	383	297	227	184	163	155	156	159	160	155
1950	136	108	84	61	41	24	6	-14	-43	-80
1960	-115	-147	-180	-204	-224	-241	-250	-252	-246	-222
1970	-180	-118	-33	43	100	158	217	302	316	316
1980	318	310	296	284	272	255	233	209	181	146
1990	113	92	82	81	86	96	109	121	129	136
2000	140	137	123	99	71	33	-18	-63	-119	-180
2010	-233	-280	-306	-318	-319	-313	-300	-279	-253	-223
2020	-183	-129	-79	-49	-36	-39	-60	-91	-128	-157
2030	-175	-184	-189	-190	-189	-185	-177	-169	-153	-126
2040	-84	-42	-11	17	51	105	131	157	180	180
2050	196	205	210	211	212	217	224	231	237	240
2060	238	237	235	231	224	218	211	205	195	180
2070	157	124	88	54	29	18	15	15	18	20
2080	19	13	4	-6	-22	-39	-58	-81	-102	-119
2090	-131	-139	-144	-145	-143	-146	-146	-154	-162	-168
2100	-168	-162	-144	-117	-95	-84	-83	-88	-94	-95

TO BE CONTINUED

CONTINUED(S-2110 EAST)

NO.	(1)	(2)	(3)	(4)	(5)	(6)	(7)	(8)	(9)	(10)
2110	-92	-79	-48	-12	22	56	84	101	108	111
2120	109	106	102	100	100	100	98	89	67	31
2130	-7	-41	-61	-69	-64	-42	-14	4	15	22
2140	28	34	45	59	68	71	67	51	25	25
2150	-31	-63	-93	-122	-153	-180	-201	-215	-223	-225
2160	-220	-207	-181	-140	-91	-41	18	86	126	140
2170	147	146	142	136	128	120	115	109	102	97
2180	86	65	44	29	18	7	-1	-9	-18	-28
2190	-38	-45	-49	-51	-54	-59	-58	-56	-54	-46
2200	-31	-14	0	15	24	28	29	26	17	0
2210	-27	-59	-88	-112	-132	-151	-169	-181	-189	-192
2220	-191	-185	-176	-166	-156	-146	-133	-116	-93	-69
2230	-45	-21	-3	4	9	13	17	20	24	31
2240	40	48	57	65	65	65	60	47	25	-11
2250	-60	-110	-149	-164	-173	-177	-173	-155	-124	-82
2260	-36	7	53	97	143	178	207	223	229	231
2270	233	235	236	238	234	234	225	214	203	190
2280	179	164	142	112	85	62	37	17	4	10
2290	-7	-11	-14	-12	-10	-7	-7	1	6	10
2300	13	14	13	13	11	4	-5	-18	-33	-48
2310	-61	-73	-83	-91	-98	-106	-114	-122	-128	-135
2320	-145	-156	-165	-171	-173	-171	-164	-148	-129	-116
2330	-109	-104	-102	-102	-102	-102	-101	-100	-98	-100
2340	-102	-105	-107	-110	-111	-112	-110	-101	-82	-61
2350	-45	-33	-26	-24	-24	-25	-27	-28	-29	-29
2360	-33	-36	-41	-49	-51	-52	-53	-52	-47	-40
2370	-33	-33	-35	-41	-47	-51	-55	-52	-47	-40
2380	-88	-83	-9	13	40	65	84	98	104	104
2390	100	91	76	57	32	7	-21	-52	-83	-105
2400	-114	-117	-112	-99	-83	-66	-53	-45	-39	-33
2410	-39	-25	-21	-16	-8	4	26	51	74	91
2420	101	106	107	106	101	96	89	83	77	70
2430	62	57	50	44	37	32	29	30	38	50
2440	62	73	81	95	104	107	107	103	93	78
2450	60	45	33	27	23	15	8	3	0	-2
2460	-1	3	8	15	20	24	26	26	24	15
2470	0	-21	-48	-69	-86	-97	-103	-104	-103	-102
2480	-102	-103	-103	-103	-101	-99	-97	-95	-93	-92
2490	-93	-95	-97	-98	-97	-97	-97	-99	-95	-86
2500	-75	-63	-50	-37	-22	-8	6	22	40	58
2510	71	83	89	91	89	85	70	55	52	15
2520	-4	-20	-39	-59	-77	-85	-89	-86	-73	-53
2530	-32	-13	4	18	28	40	52	64	73	80
2540	88	97	110	126	150	175	198	215	226	230
2550	228	220	203	178	149	120	95	74	59	45
2560	33	26	22	21	25	31	36	42	47	51
2570	54	58	64	67	69	69	65	57	46	37
2580	29	26	25	26	26	26	27	27	26	22
2590	18	13	2	-10	-26	-42	-56	-66	-77	-92
2600	-114	-142	-167	-191	-208	-222	-229	-229	-220	-202
2610	-176	-135	-85	-46	-9	33	65	79	86	91
2620	92	91	89	82	69	52	32	12	-2	-17
2630	-29	-34	-35	-32	-24	-12	2	16	25	28
2640	28	25	21	18	15	8	1	-7	-20	-51

TO BE CONTINUED

CONTINUED(S-2110 EAST)

NO.	(1)	(2)	(3)	(4)	(5)	(6)	(7)	(8)	(9)	(10)
2650	-41	-48	-52	-52	-50	-43	-31	-17	5	0
2660	40	58	73	86	98	112	126	141	154	162
2670	167	171	171	162	142	116	80	43	0	-39
2680	-74	-103	-121	-133	-138	-138	-133	-115	-89	-56
2690	-18	17	48	69	81	89	92	95	95	95
2700	95	93	95	97	95	93	88	79	69	62
2710	56	52	48	46	46	47	50	53	56	47
2720	58	58	57	57	54	51	48	48	48	47
2730	48	49	48	49	51	51	49	46	44	39
2740	33	27	19	9	0	-9	-19	-30	-42	-54
2750	-65	-74	-79	-80	-78	-74	-66	-55	-43	-28
2760	-13	1	12	20	24	24	17	9	0	-8
2770	-18	-29	-43	-56	-70	-81	-88	-90	-91	-89
2780	-88	-87	-85	-83	-79	-71	-56	-43	-30	-20
2790	-14	-7	-1	3	10	18	28	37	47	56
2800	67	79	92	102	110	116	118	117	115	113
2810	110	105	102	101	103	105	108	109	110	108
2820	105	102	99	96	93	90	86	83	80	78
2830	75	70	59	47	36	25	14	6	0	-10
2840	-28	-48	-67	-82	-96	-114	-132	-150	-168	-186
2850	-95	-98	-104	-112	-123	-138	-156	-174	-192	-210
2860	-123	-116	-109	-100	-89	-79	-69	-63	-62	-62
2870	-64	-73	-89	-102	-113	-123	-130	-133	-135	-135
2880	-134	-130	-122	-114	-108	-102	-97	-91	-87	-86
2890	-33	-29	-26	-24	-22	-21	-20	-19	-18	-17
2900	-64	-51	-48	-42	-33	-23	-12	0	13	25
2910	35	45	56	66	75	84	95	108	120	126
2920	128	125	117	107	97	87	76	63	52	41
2930	29	20	15	8	2	0	-5	-14	-21	-30
2940	-37	-46	-55	-63	-72	-80	-91	-103	-117	-128
2950	-139	-147	-149	-150	-147	-136	-121	-109	-99	-89
2960	-82	-74	-68	-60	-54	-45	-33	-21	-10	-3
2970	1	5	10	15	20	25	34	46	56	66
2980	77	87	94	98	102	105	107	108	108	105
2990	102	99	96	93	85	72	59	45	33	23
3000	15	9	8	11	13	14	15	12	6	-1
3010	-13	-26	-39	-51	-59	-65	-69	-70	-70	-66
3020	-63	-59	-51	-38	-22	1	22	46	67	80
3030	86	89	89	87	84	79	74	66	56	41
3040	28	11	-13	-36	-58	-82	-103	-120	-133	-145
3050	-154	-163	-168	-169	-167	-167	-166	-165	-163	-161
3060	-158	-155	-151	-145	-140	-133	-126	-119	-112	-105
3070	-97	-91	-84	-76	-68	-59	-48	-30	-2	22
3080	37	48	59	72	86	96	107	121	135	149
3090	164	181	196	208	220	228	231	231	230	230
3100	229	223	214	200	184	169	156	142	129	118
3110	110	104	94	88	83	78	69	58	45	29
3120	12	-8	-32	-51	-66	-78	-88	-97	-101	-105
3130	-108	-107	-102	-89	-68	-40	-10	17	36	50
3140	61	66	68	67	64	60	54	49	45	43
3150	43	44	45	47	51	54	56	59	60	62
3160	62	60	57	54	49	43	35	18	0	-19
3170	-37	-53	-68	-79	-88	-97	-106	-114	-122	-130
3180	-134	-136	-138	-140	-140	-135	-135	-134	-135	-136

TO BE CONTINUED

CONTINUED< S-211D EAST

CONTINUED< S-211D EAST

>

NO.	(1)	(2)	(3)	(4)	(5)	(6)	(7)	(8)	(9)	(10)
3190	-140	-146	-151	-157	-164	-168	-168	-165	-157	-145
3200	-131	-112	-90	-69	-47	-24	0	20	37	53
3210	66	81	92	96	103	113	124	136	147	158
3220	167	180	181	180	177	172	164	154	143	143
3230	132	121	112	106	98	87	75	67	57	47
3240	38	32	29	25	22	20	19	16	14	14
3250	13	15	20	27	36	44	52	58	63	68
3260	71	72	70	67	63	56	44	32	22	12
3270	0	-11	-32	-33	-43	-50	-54	-58	-62	-66
3280	-74	-81	-90	-97	-105	-112	-119	-124	-127	-126
3290	-126	-123	-121	-119	-113	-100	-86	-71	-59	-45
3300	-39	-13	3	18	29	40	50	58	63	65
3310	68	68	67	66	66	64	62	61	62	63
3320	64	65	65	66	67	70	74	79	84	90
3330	97	103	110	113	116	119	121	121	123	124
3340	126	126	124	120	113	102	90	77	64	50
3350	58	28	20	10	0	-10	-21	-32	-39	-45
3360	-34	-61	-66	-71	-73	-74	-67	-64	-64	-64
3370	-64	-62	-63	-65	-66	-64	-63	-62	-61	-61
3380	-61	-62	-60	-59	-58	-54	-45	-34	-24	-12
3390	0	12	20	29	36	44	50	55	59	64
3400	68	71	72	72	72	71	69	68	68	68
3410	68	68	66	65	64	62	58	56	55	56
3420	57	56	54	52	50	46	40	33	26	17
3430	11	7	0	0	-1	-4	-6	-9	-11	-14
3440	-17	-19	-19	-20	-23	-26	-27	-27	-29	-31
3450	-30	-31	-32	-32	-32	-33	-33	-34	-37	-43
3460	-50	-60	-70	-76	-82	-85	-86	-83	-82	-79
3470	-73	-67	-63	-59	-54	-44	-32	-18	-3	10
3480	24	43	62	80	100	119	135	144	151	154
3490	156	158	159	157	152	145	134	123	111	101
3500	90	78	67	54	44	38	36	38	46	55
3510	64	72	78	84	88	83	86	82	72	58
3520	39	22	4	-16	-35	-54	-69	-81	-89	-96
3530	-102	-105	-107	-108	-108	-108	-108	-104	-102	-95
3540	-88	-81	-73	-66	-61	-57	-52	-46	-41	-33
3550	-24	-17	-10	-5	0	4	8	9	12	13
3560	13	11	11	7	2	-3	-9	-14	-20	-28
3570	-39	-52	-62	-68	-72	-77	-81	-82	-80	-77
3580	-72	-63	-51	-38	-27	-17	-11	-5	-1	-2
3590	-4	-7	0	8	10	12	13	15	16	15
3600	-12	-7	0	13	28	44	59	70	80	87
3610	90	90	91	92	92	92	92	91	91	92
3620	95	96	97	98	97	93	90	87	82	77
3630	70	63	50	37	26	14	1	-10	-18	-26
3640	-35	-42	-46	-49	-50	-51	-50	-48	-44	-44
3650	-43	-46	-49	-53	-58	-65	-74	-86	-102	-116
3660	-129	-137	-144	-149	-151	-149	-145	-139	-131	-122
3670	-109	-91	-74	-54	-34	0	13	24	34	34
3680	41	46	48	50	53	53	50	47	44	40
3690	36	31	25	18	10	1	-7	-16	-25	-35
3700	-46	-54	-62	-69	-71	-75	-79	-79	-78	-83
3710	-88	-90	-94	-97	-97	-97	-94	-91	-89	-86
3720	-77	-68	-59	-51	-39	-15	-9	-2	9	21

TO BE CONTINUED

TO BE CONTINUED

CONTINUED (S-2110 EAST)										
NO.	(1)	(2)	(3)	(4)	(5)	(6)	(7)	(8)	(9)	(10)
4270	-48	-48	-46	-45	-44	-42	-40	-37	-35	-31
4280	-27	-24	-21	-19	-15	-10	-6	0	6	13
4290	18	21	22	22	21	18	16	10	3	-2
4300	-7	-14	-19	-24	-28	-30	-32	-31	-28	-28
4310	-23	-10	-2	10	20	31	41	50	56	60
4320	62	62	60	56	52	48	42	35	27	21
4330	13	4	-2	-9	-14	-18	-23	-28	-31	-36
4340	-39	-42	-44	-45	-47	-47	-46	-46	-47	-48
4350	-48	-46	-46	-46	-46	-45	-45	-45	-45	-43
4360	-39	-32	-24	-16	-5	6	17	25	35	42
4370	45	49	51	51	52	52	50	47	46	42
4380	38	33	27	22	16	10	5	1	0	0
4390	2	4	7	9	11	11	13	16	19	22
4400	25	28	30	33	33	33	33	32	28	25
4410	23	22	21	19	14	11	8	5	1	1
4420	-1	-4	-8	-11	-12	-14	-15	-17	-18	-19
4430	-20	-22	-24	-25	-27	-30	-32	-33	-31	-29
4440	-29	-26	-22	-20	-17	-15	-13	-11	-7	-3
4450	2	10	15	17	19	20	21	23	26	30
4460	35	40	45	51	57	62	66	71	76	78
4470	80	81	81	80	79	77	75	72	68	64
4480	61	58	56	56	55	53	50	48	45	43
4490	41	40	40	39	38	38	38	37	37	39
4500	36	34	32	30	28	24	20	17	13	9
4510	6	5	4	2	0	0	0	0	1	2
4520	2	2	1	0	-3	-8	-13	-15	-16	-19
4530	-21	-24	-26	-29	-32	-33	-35	-38	-41	-41
4540	-41	-42	-43	-43	-43	-43	-43	-44	-46	-46
4550	-46	-46	-46	-46	-46	-46	-46	-44	-43	-41
4560	-38	-33	-25	-19	-13	-6	1	8	16	21
4570	25	30	35	40	46	53	58	62	65	69
4580	72	72	72	71	68	63	57	48	39	29
4590	18	8	-1	-11	-19	-25	-32	-36	-39	-41
4600	-41	-41	-42	-42	-43	-43	-43	-44	-44	-44
4610	-44	-44	-44	-43	-43	-43	-43	-44	-44	-44
4620	-38	-38	-36	-34	-33	-30	-30	-32	-33	-34
4630	-37	-39	-42	-44	-46	-48	-48	-49	-49	-49
4640	-49	-48	-48	-47	-48	-48	-48	-47	-46	-44
4650	-43	-41	-39	-36	-33	-29	-25	-22	-20	-18
4660	-17	-16	-14	-12	-11	-9	-8	-5	-2	3
4670	19	26	33	39	43	46	49	50	51	50
4680	49	47	42	38	33	28	23	19	14	10
4690	6	4	3	0	-1	-3	-5	-6	-7	-6
4700	-4	-2	-2	0	0	0	0	0	0	-2
4710	-6	-10	-13	-18	-23	-26	-30	-36	-41	-41
4720	-42	-43	-43	-43	-43	-42	-41	-38	-38	-37
4730	-34	-30	-26	-23	-21	-17	-13	-8	-2	2
4740	9	16	21	27	33	38	45	51	56	60
4750	64	68	70	70	70	71	71	71	69	65
4760	61	57	53	48	42	36	31	25	19	12
4770	1	2	0	-4	-8	-10	-10	-9	-6	-3
4780	1	8	14	20	24	25	27	29	29	28
4790	26	23	22	18	13	9	7	2	-2	-7
4800	-13	-19	-24	-32	-37	-38	-38	-38	-38	-39

TO BE CONTINUED

CONTINUED (S-2110 EAST)										
NO.	(1)	(2)	(3)	(4)	(5)	(6)	(7)	(8)	(9)	(10)
4810	-38	-37	-35	-32	-27	-22	-19	-14	-9	-7
4820	-5	-1	4	7	17	27	32	37	42	47
4830	29	34	40	46	52	57	61	64	65	67
4840	68	67	65	63	59	54	47	39	31	22
4850	12	0	-10	-21	-33	-45	-56	-66	-76	-85
4860	-94	-102	-109	-114	-118	-120	-123	-124	-121	-117
4870	-112	-107	-103	-97	-89	-84	-80	-76	-71	-67
4880	-69	-67	-64	-60	-57	-54	-53	-49	-46	-42
4890	-37	-34	-32	-32	-32	-32	-32	-32	-32	-33
4900	-34	-34	-34	-34	-34	-34	-34	-34	-34	-35
4910	-34	-31	-28	-25	-23	-20	-19	-18	-16	-12
4920	-10	-9	-7	-5	-7	-7	-6	-5	-4	-1
4930	2	7	10	15	18	20	22	25	28	32
4940	36	40	44	47	51	56	61	66	69	72
4950	75	78	81	82	81	79	78	75	73	69
4960	64	60	56	53	48	43	35	28	23	21
4970	18	17	17	18	18	18	18	18	20	22
4980	23	26	29	32	34	37	40	42	45	44
4990	45	44	42	41	40	39	38	37	34	31
5000	28	26	23	21	19	17	15	14	13	13
5010	13	13	11	9	8	8	8	8	7	7
5020	8	8	8	9	10	10	10	12	14	15
5030	16	17	18	18	18	18	18	18	15	11
5040	9	5	3	1	-1	-2	-3	-4	-4	-4
5050	-3	-3	-3	-4	-4	-2	-3	-6	-8	-9
5060	-10	-12	-14	-18	-21	-24	-30	-36	-40	-45
5070	-49	-51	-54	-56	-56	-56	-56	-54	-51	-50
5080	-48	-47	-45	-43	-38	-34	-30	-26	-23	-18
5090	-12	-6	-1	5	13	19	26	31	36	40
5100	42	43	43	42	42	42	40	40	40	40
5110	40	41	41	43	43	44	46	47	47	46
5120	46	45	43	40	38	35	33	28	24	20
5130	15	11	7	5	1	-2	-6	-9	-13	-17
5140	-21	-24	-30	-33	-35	-40	-43	-44	-44	-43
5150	-44	-44	-44	-45	-48	-48	-49	-50	-51	-51
5160	-52	-51	-51	-53	-55	-55	-50	-50	-51	-51
5170	-63	-62	-63	-62	-60	-59	-58	-55	-54	-54
5180	-54	-54	-54	-54	-54	-55	-57	-59	-60	-61
5190	-60	-59	-57	-55	-53	-51	-48	-45	-43	-39
5200	-34	-29	-24	-18	-11	-3	4	13	20	26
5210	32	38	43	48	53	55	55	55	57	57
5220	59	61	65	67	68	68	68	68	66	65
5230	62	60	56	55	55	55	56	57	58	61
5240	63	67	68	70	71	71	70	68	65	61
5250	54	46	39	32	24	17	11	4	-2	-7
5260	-12	-17	-21	-25	-29	-31	-32	-33	-34	-34
5270	-35	-32	-31	-29	-28	-26	-25	-22	-18	-15
5280	-11	-7	-5	-3	-1	0	2	5	9	13
5290	16	22	25	28	32	36	39	40	43	45
5300	46	49	50	51	51	51	51	50	50	50
5310	47	46	44	40	37	33	29	24	20	14
5320	6	-1	-9	-17	-23	-30	-37	-45	-52	-56
5330	-59	-61	-62	-65	-64	-64	-63	-62	-62	-62
5340	-60	-58	-56	-52	-48	-44	-39	-34	-29	-25

TO BE CONTINUED

CONTINUED (S-2110 EAST)										CONTINUED (S-2110 EAST)											
NO.	(1)	(2)	(3)	(4)	(5)	(6)	(7)	(8)	(9)	(10)	NO.	(1)	(2)	(3)	(4)	(5)	(6)	(7)	(8)	(9)	(10)
5350	-21	-17	-12	-7	-4	-1	1	2	2	2	5890	-64	-64	-64	-64	-64	-63	-62	-60	-58	-57
5360	2	0	0	-1	-3	-5	-6	-7	-8	-10	5900	-54	-51	-44	-41	-38	-35	-30	-24	-17	-16
5370	-13	-17	-20	-23	-29	-35	-37	-40	-42	-44	5910	-13	-8	-5	-3	0	2	5	8	10	14
5380	-44	-44	-43	-42	-40	-38	-38	-38	-35	-34	5920	19	22	25	30	34	37	40	44	46	49
5390	-30	-30	-29	-28	-28	-28	-26	-22	-19	-17	5930	51	53	53	54	55	53	51	51	50	48
5400	-14	-11	-9	-10	-11	-12	-11	-11	-13	-14	5940	47	45	45	45	45	45	44	40	36	33
5410	-14	-12	-13	-12	-10	-6	-4	-1	0	2	5950	32	30	28	25	20	15	13	10	6	3
5420	2	2	1	0	-1	-3	-6	-8	-9	-9	5960	0	-4	-7	-10	-13	-13	-13	-13	-15	-16
5430	-9	-7	-6	-5	-3	-1	0	2	2	3	5970	-16	-17	-18	-21	-24	-27	-31	-37	-41	-41
5440	5	7	9	10	11	13	15	18	20	21	5980	-43	-46	-46	-46	-44	-44	-43	-41	-38	-36
5450	22	22	22	20	18	17	14	12	12	11	5990	-34	-32	-32	-31	-29	-26	-23	-21	-16	-11
5460	11	11	11	9	7	8	5	2	2	2											
5470	2	1	-1	-3	-7	-12	-16	-21	-24	-32											
5480	-38	-43	-47	-50	-54	-57	-58	-60	-61	-61											
5490	-59	-60	-59	-56	-49	-36	-29	-24	-18	-18											
5500	-12	-5	2	9	14	19	23	29	34	40											
5510	46	52	56	60	65	69	72	76	78	79											
5520	81	82	82	82	80	79	77	75	72	69											
5530	65	59	53	49	44	40	36	32	29	25											
5540	22	18	14	10	5	-1	-7	-12	-17	-21											
5550	-25	-27	-32	-35	-37	-41	-43	-43	-48	-52											
5560	-53	-53	-53	-52	-51	-47	-44	-43	-41	-37											
5570	-32	-28	-24	-21	-17	-14	-9	-5	0	5											
5580	9	15	20	22	23	24	27	29	29	28											
5590	30	31	31	31	31	29	28	26	24	23											
5600	22	22	20	17	13	8	4	1	-1	-1											
5610	-4	-5	-6	-5	-4	-3	-3	-3	-3	-1											
5620	-1	0	0	1	0	-1	-2	-3	-5	-6											
5630	-8	-11	-12	-13	-15	-18	-21	-25	-31	-35											
5640	-26	-27	-29	-31	-32	-32	-33	-34	-34	-31											
5650	-29	-32	-29	-27	-23	-21	-18	-16	-12	-6											
5660	-3	-3	-3	-3	-1	-1	0	0	1	4											
5670	5	6	6	7	6	2	0	-1	-1	-3											
5680	-6	-8	-9	-10	-11	-12	-13	-14	-15	-17											
5690	-20	-21	-21	-21	-21	-21	-22	-23	-25	-21											
5700	-21	-22	-23	-24	-26	-28	-29	-32	-35	-37											
5710	-39	-40	-42	-42	-42	-41	-37	-34	-30	-25											
5720	-20	-16	-10	-5	-2	0	1	4	7	11											
5730	15	18	20	21	23	26	31	39	44	49											
5740	53	57	61	61	63	66	66	67	66	64											
5750	63	64	64	63	65	68	70	72	74	78											
5760	82	84	85	86	85	84	81	78	75	71											
5770	66	62	59	56	53	49	45	41	37	34											
5780	32	30	27	25	23	20	19	16	13	10											
5790	7	5	4	3	1	0	-1	-1	-3	-5											
5800	-6	-10	-13	-16	-18	-20	-25	-28	-29	-28											
5810	-28	-31	-30	-29	-28	-26	-23	-19	-17	-14											
5820	-12	-9	-6	-4	0	4	8	11	16	21											
5830	23	28	33	35	38	41	43	44	45	45											
5840	45	46	45	44	43	41	38	36	34	32											
5850	29	28	26	24	19	15	10	4	0	-4											
5860	-9	-12	-17	-21	-25	-30	-33	-37	-41	-46											
5870	-51	-56	-59	-61	-62	-63	-64	-64	-64	-63											
5880	-64	-64	-63	-63	-64	-64	-64	-64	-64	-63											

END

TO BE CONTINUED

RECORD = S-2110 COMPONENT = DOWN STATION = KASHIMA-ZOKAN-S
 DATE AND TIME = 1987-12-17-11-08 TOTAL NUMBER OF DATA = 6000
 SAMPLING INTERVAL = 0.010 (SEC) SCAL = 0.10000
 SIGNAL = GR. ACC.
 CONNECTION POINT IN DATA NUMBER = 3041, 6000,

NO.	(1)	(2)	(3)	(4)	(5)	(6)	(7)	(8)	(9)	(10)
0	-18	-19	-20	-20	-21	-22	-24	-27	-30	-33
10	-36	-39	-40	-40	-40	-40	-40	-40	-40	-40
20	-23	-21	-18	-16	-15	-15	-13	-10	-8	-6
30	-4	-1	4	4	6	6	3	0	-4	-6
40	-7	-7	-4	0	5	12	19	25	26	27
50	21	14	-9	-17	-10	-11	-12	-15	-12	-12
60	-9	-14	-17	-20	-10	4	36	65	90	100
70	104	102	96	89	81	69	56	44	27	1
80	-38	-66	-68	-45	-8	14	26	23	-9	-60
90	-114	-144	-140	-111	-64	-4	22	31	22	0
100	-23	-32	-28	-8	24	62	99	123	137	145
110	149	150	147	137	117	89	61	31	4	-19
120	-48	-71	-87	-96	-102	-103	-98	-87	-76	-64
130	-43	-20	0	21	40	44	34	15	-11	-37
140	-59	-68	-62	-49	-41	-42	-44	-42	-30	-9
150	2	0	-13	-27	-38	-44	-45	-37	-18	4
160	27	39	39	30	18	6	-4	-15	-27	-33
170	-31	-14	12	31	33	26	15	5	-5	-13
180	-35	-38	-48	-50	-46	-38	-27	-7	16	27
190	38	38	72	69	49	31	52	58	107	164
200	212	234	224	169	93	40	26	25	17	-19
210	-83	-133	-149	-148	-137	-121	-105	-93	-82	-70
220	-23	-23	18	58	97	137	173	199	215	213
230	174	87	-23	-142	-232	-286	-301	-285	-245	-198
240	-166	-145	-88	50	185	220	204	166	122	91
250	72	56	32	0	-35	-64	-84	-79	-38	31
260	101	103	181	141	65	23	11	8	5	-14
270	-60	-94	-95	-53	8	56	75	64	33	5
280	-13	-23	-19	9	53	84	93	87	71	49
290	14	-45	-120	-178	-226	-254	-246	-206	-146	-76
300	-3	58	106	151	197	234	259	274	276	257
310	220	178	135	98	79	65	65	65	65	58
320	67	26	2	-18	-30	-37	-61	-121	-190	-257
330	-835	-887	-275	-241	-197	-154	-111	-57	-2	38
340	64	71	61	39	28	33	56	71	65	35
350	-4	-43	-63	-65	-58	-43	-27	-17	-65	19
360	26	2	-17	-13	17	60	102	129	135	126
370	112	93	70	46	19	-12	-49	-98	-139	221
380	-272	-309	-260	-195	-107	-5	103	191	240	8
390	250	242	230	222	215	199	172	135	90	46
400	7	-24	-42	-50	-54	-56	-56	-52	-45	-31
410	-15	-2	-1	-10	-26	-41	-41	-28	-9	7
420	20	24	24	24	23	24	29	40	51	55
430	33	15	0	-9	-10	-6	5	25	45	68
440	69	74	75	74	65	32	-18	-75	-105	-107
450	-85	-53	-35	-35	-40	-40	-28	-4	13	18
460	12	-6	-39	-79	-114	-135	-139	-133	-129	-129
470	-120	-95	-54	-15	12	25	30	33	41	57
480	78	99	113	117	98	48	1	-22	-13	40

TO BE CONTINUED

TO BE CONTINUED

CONTINUED (S-2110 DOWN)

CONTINUED (S-2110 DOWN)

NO.	(1)	(2)	(3)	(4)	(5)	(6)	(7)	(8)	(9)	(10)
1030	-4	0	6	14	16	8	-9	-35	-60	-74
1040	-68	-47	-22	-57	-74	-18	-30	-41	-47	-49
1050	-49	-49	-52	-59	-74	-96	-119	-134	-138	-132
1060	-114	-86	-53	-20	8	34	62	92	114	123
1070	119	107	91	81	86	97	104	104	95	95
1080	74	41	-17	-34	-45	-54	-60	-61	-60	-60
1090	-56	-51	-44	-39	-36	-35	-39	-42	-39	-42
1100	-13	33	73	95	92	59	13	-25	-53	-65
1110	-61	-51	-42	-40	-46	-59	-74	-90	-104	-118
1120	-133	-145	-148	-139	-117	-79	-35	-148	-160	-175
1130	16	2	-11	-14	-4	15	41	65	79	84
1140	86	86	88	93	97	97	89	67	33	-10
1150	-53	-88	-109	-116	-109	-82	-45	-9	20	45
1160	69	98	126	143	132	90	27	-38	-75	-85
1170	-78	-68	-61	-55	-51	-44	-23	16	54	84
1180	86	69	38	3	-24	-38	-40	-36	-19	3
1190	27	60	90	114	131	144	151	145	105	43
1200	-26	-94	-147	-174	-182	-180	-171	-160	-154	-154
1210	-158	-167	-175	-180	-183	-183	-180	-177	-174	-166
1220	-143	-103	-62	-34	-21	-16	-17	-23	-28	-29
1230	-27	-20	-10	-3	-5	-12	-23	-28	-53	-6
1240	25	66	103	124	131	126	106	78	51	35
1250	26	21	23	38	76	117	148	165	172	175
1260	172	164	146	111	69	35	16	9	15	29
1270	56	90	120	144	160	167	167	158	136	100
1280	51	-29	-49	-58	-64	-66	-66	-67	-70	-73
1290	-75	-73	-68	-64	-60	-58	-58	-58	-58	-58
1300	-59	-58	-56	-53	-48	-47	-50	-57	-69	-90
1310	-113	-133	-145	-143	-127	-96	-57	-76	-9	-2
1320	-1	-4	-13	-30	-47	-60	-67	-70	-71	-69
1330	-67	-65	-62	-55	-44	-28	-4	17	29	31
1340	18	-15	-68	-113	-147	-167	-171	-160	-160	-107
1350	-71	-49	-37	-26	-12	-2	5	18	29	36
1360	46	51	67	97	141	176	199	217	231	256
1370	232	219	196	169	142	119	99	80	61	44
1380	28	18	13	12	18	31	46	55	55	47
1390	35	27	27	36	51	65	72	70	60	41
1400	20	2	-11	-22	-29	-33	-35	-34	-32	-31
1410	-30	-33	-39	-47	-52	-54	-52	-49	-50	-59
1420	-79	-108	-129	-138	-128	-94	-48	-17	1	14
1430	6	-16	-46	-80	-105	-121	-128	-134	-135	-134
1440	-129	-121	-103	-77	-54	-36	-16	15	58	95
1450	122	138	133	106	61	0	-49	-75	-85	-83
1460	-73	-60	-46	-36	-29	-22	-15	-6	5	18
1470	30	40	50	60	70	81	94	114	138	159
1480	172	179	180	173	161	144	127	113	103	97
1490	91	84	73	54	30	7	-10	-23	-28	-27
1500	-23	-14	-5	0	1	-6	-27	-59	-59	-42
1510	-143	-148	-142	-120	-86	-50	-20	-2	3	5
1520	1	-6	-12	-17	-21	-25	-26	-24	-20	-20
1530	-15	-10	-6	-4	-3	0	7	16	29	43
1540	54	61	63	60	55	46	36	24	13	2
1550	-11	-26	-40	-54	-65	-75	-80	-78	-70	-69
1560	-13	28	65	92	105	109	108	100	87	71

TO BE CONTINUED

TO BE CONTINUED

CONTINUED(S-2110 DOWN)

CONTINUED(S-2110 DOWN)

NO.	(1)	(2)	(3)	(4)	(5)	(6)	(7)	(8)	(9)	(10)
2110	89	90	85	76	62	45	28	14	4	
2120	0	-2	-4	-5	-8	-11	-16	-15	-6	
2130	10	31	49	60	66	69	67	63	56	
2140	48	40	31	22	16	11	-7	-17	-7	
2150	-29	-44	-59	-72	-84	-91	-97	-102	-105	
2160	-101	-96	-89	-82	-74	-68	-64	-64	-66	
2170	-69	-72	-75	-78	-79	-77	-72	-69	-66	
2180	-9	16	33	44	50	55	59	59	59	
2190	58	55	50	44	38	36	39	42	49	
2200	65	84	101	115	125	129	127	118	106	
2210	67	49	35	25	20	20	24	35	45	
2220	57	60	62	62	63	67	72	77	84	
2230	95	97	98	97	96	91	80	65	49	
2240	24	14	6	-1	-9	-16	-23	-26	-29	
2250	-29	-30	-30	-29	-32	-34	-37	-42	-47	
2260	-54	-58	-63	-68	-73	-77	-80	-81	-83	
2270	-80	-75	-71	-70	-69	-69	-70	-72	-75	
2280	-75	-73	-64	-51	-34	3	20	31	37	
2290	44	47	52	54	58	60	59	58	57	
2300	55	54	51	46	40	34	27	22	19	
2310	18	17	16	17	19	23	27	29	30	
2320	26	21	17	14	11	8	12	15	20	
2330	25	26	24	24	24	24	24	24	24	
2340	16	36	54	68	80	90	98	103	104	
2350	99	97	94	86	82	75	61	44	28	
2360	16	3	-7	-16	-23	-32	-39	-46	-51	
2370	-63	-67	-72	-77	-81	-83	-84	-83	-79	
2380	-64	-52	-37	-25	-14	-4	2	6	9	
2390	9	7	3	-1	-9	-17	-25	-29	-30	
2400	-30	-30	-28	-27	-28	-26	-22	-17	-13	
2410	-3	1	4	6	9	11	9	2	-8	
2420	-30	-36	-40	-42	-42	-42	-40	-38	-21	
2430	-42	-47	-52	-58	-65	-68	-70	-70	-66	
2440	-63	-58	-55	-54	-56	-58	-59	-61	-63	
2450	-66	-66	-66	-66	-66	-67	-64	-58	-51	
2460	-33	-21	-11	-3	3	8	11	13	14	
2470	11	6	0	-5	-11	-18	-25	-31	-37	
2480	-44	-43	-39	-35	-24	-15	-7	0	7	
2490	17	21	25	30	36	36	35	31	24	
2500	19	17	13	11	10	10	12	14	15	
2510	17	18	19	21	21	20	18	18	19	
2520	20	21	21	21	20	16	13	5	-2	
2530	-16	-23	-27	-31	-33	-32	-27	-24	-21	
2540	-17	-14	-14	-15	-13	-12	-12	-15	-19	
2550	-24	-27	-30	-31	-27	-22	-19	-15	-9	
2560	2	13	24	34	40	45	51	56	59	
2570	67	69	72	76	80	83	84	84	86	
2580	80	74	66	59	53	48	45	40	37	
2590	30	27	24	19	15	11	7	3	-1	
2600	-6	-2	0	3	4	5	8	9	9	
2610	6	5	3	0	1	1	6	12	17	
2620	28	33	40	50	59	68	78	86	92	
2630	101	102	103	102	99	95	91	88	86	
2640	84	82	80	75	68	62	59	56	53	

TO BE CONTINUED

TO BE CONTINUED

CONTINUED(S-2110 DOWN)		CONTINUED(S-2110 DOWN)										TO BE CONTINUED									
NO.	(1)	(2)	(3)	(4)	(5)	(6)	(7)	(8)	(9)	(10)	(1)	(2)	(3)	(4)	(5)	(6)	(7)	(8)	(9)	(10)	
3190	44	41	38	35	31	28	24	19	13	8	8	67	66	63	60	58	55	49	44	39	35
3200	4	3	2	3	3	2	-1	-3	-5	-5	7	31	28	25	21	19	17	14	11	11	10
3210	-6	-9	-11	-10	-9	-4	0	2	5	7	7	8	7	9	10	10	10	11	14	17	18
3220	12	16	18	20	21	22	20	18	16	15	15	21	24	26	27	26	24	23	21	17	14
3230	15	15	15	15	14	15	16	16	14	10	10	13	11	10	9	6	4	1	0	-4	-9
3240	5	0	-5	-9	-12	-13	-15	-18	-21	-24	-24	-14	-22	-26	-30	-34	-35	-37	-41	-46	-52
3250	-27	-29	-30	-32	-31	-37	-49	-49	-54	-58	-58	-57	-61	-66	-70	-75	-78	-82	-85	-86	-87
3260	-61	-63	-67	-71	-74	-77	-79	-77	-76	-77	-76	-87	-85	-83	-79	-73	-64	-57	-51	-45	-39
3270	-75	-73	-68	-67	-66	-62	-61	-60	-57	-56	-56	-33	-28	-23	-14	-10	-6	-2	2	7	7
3280	-56	-57	-60	-61	-65	-70	-73	-76	-78	-81	-81	10	13	17	20	22	23	23	22	19	16
3290	-78	-74	-72	-70	-68	-66	-60	-57	-52	-48	-48	14	14	12	10	7	4	0	-2	-5	-8
3300	-45	-37	-35	-29	-24	-20	-17	-12	-10	-8	-8	11	14	12	10	7	4	0	-2	-5	-8
3310	-6	-5	-5	-4	-4	-2	0	1	2	2	2	11	14	15	15	15	15	15	15	14	12
3320	2	3	4	6	8	11	14	14	15	15	15	14	15	15	15	18	18	20	22	24	26
3330	16	17	15	12	9	7	7	6	5	5	5	28	29	28	28	28	28	28	27	25	23
3340	6	7	7	7	9	14	21	25	27	28	28	28	29	28	28	28	28	28	27	25	23
3350	29	30	30	29	27	27	29	29	29	26	0	0	0	0	0	0	0	0	0	0	0
3360	24	21	16	13	8	7	5	3	0	0	0	22	19	16	14	11	10	8	4	0	-3
3370	0	-2	-1	5	5	7	8	9	8	6	6	-5	-11	-16	-19	-21	-24	-26	-28	-29	-31
3380	3	2	2	3	5	3	1	0	2	7	7	10	-5	1	7	10	12	15	17	20	21
3390	14	19	23	26	31	36	42	49	59	68	68	20	19	19	20	19	18	15	16	17	18
3400	74	81	85	88	91	93	94	95	96	96	96	94	94	93	94	93	94	93	92	90	88
3410	94	92	91	89	87	83	78	73	69	64	64	3950	18	18	18	18	18	18	18	17	15
3420	58	54	48	40	33	28	24	18	13	8	8	3950	13	13	15	20	26	26	30	33	35
3430	4	1	0	0	-1	-3	-4	-6	-5	-5	-5	3970	38	41	46	48	48	46	43	42	41
3440	-6	-9	-15	-12	-10	-10	-8	-6	-2	0	0	3980	40	37	35	29	26	24	21	20	19
3450	0	2	2	3	3	4	4	4	3	3	3	3990	14	13	10	8	5	3	2	-1	-3
3460	23	25	27	31	36	39	42	47	49	49	49	4	-6	-8	-9	-9	-9	-8	-6	-3	0
3470	51	54	54	54	54	54	54	54	53	53	53	4	8	10	13	18	22	27	33	37	39
3480	52	50	48	46	45	44	41	37	34	32	32	4020	42	46	48	50	51	47	45	44	43
3490	28	25	20	16	11	7	5	5	0	-4	-4	4030	40	36	34	29	25	23	18	14	12
3500	-7	-9	-9	-10	-9	-6	-5	-3	0	3	5	4840	9	5	3	-1	-5	-8	-11	-12	-13
3510	6	9	10	11	11	8	5	3	-1	-5	-5	4050	-17	-17	-16	-14	-16	-16	-16	-15	-14
3520	-8	-13	-18	-20	-23	-29	-35	-41	-48	-54	-54	4060	-12	-12	-13	-14	-13	-11	-10	-9	-9
3530	-55	-58	-61	-65	-68	-72	-75	-77	-80	-81	-81	4070	-9	-9	-9	-5	-1	-1	0	0	0
3540	-80	-82	-82	-78	-74	-70	-68	-65	-60	-55	-55	4080	-2	-3	-5	-5	-6	-9	-11	-13	-15
3550	-52	-49	-45	-42	-39	-35	-30	-26	-24	-22	-22	4090	-18	-21	-26	-30	-33	-44	-44	-47	-51
3560	-19	-17	-17	-16	-14	-11	-9	-9	-9	-9	-9	4100	-50	-51	-51	-52	-53	-52	-51	-51	-51
3570	-9	-9	-11	-12	-15	-17	-22	-27	-30	-36	-36	4110	-20	-20	-20	-20	-22	-22	-22	-22	-22
3580	-62	-65	-66	-67	-68	-68	-64	-61	-58	-54	-54	4120	-45	-45	-45	-45	-45	-45	-45	-45	-45
3590	-33	-31	-29	-28	-27	-27	-27	-27	-27	-27	-27	4130	24	31	39	46	51	55	59	64	65
3600	-48	-46	-45	-42	-39	-38	-34	-33	-34	-33	-33	4140	65	67	67	66	66	66	66	66	66
3610	-30	-26	-23	-19	-13	-10	-6	-1	3	8	8	4150	35	29	24	19	15	9	3	-3	-7
3620	16	19	23	25	27	27	27	28	30	30	30	4160	-12	-16	-18	-19	-19	-19	-17	-15	-14
3630	29	29	30	29	27	25	19	15	12	10	10	4170	-4	-4	-4	-4	-5	-6	-7	-7	-6
3640	9	8	7	8	11	14	14	17	21	25	25	4180	-4	-4	-5	-5	-5	-5	-4	-4	-4
3650	27	26	26	26	26	27	28	29	29	30	30	4190	-14	-13	-12	-10	-8	-7	-5	-4	0
3660	31	32	32	35	36	35	36	35	32	29	29	4200	5	9	13	17	22	24	27	27	28
3670	27	25	21	18	16	13	11	10	8	7	7	4210	28	29	32	30	28	26	23	18	15
3680	7	10	11	12	12	12	11	10	9	6	6	4220	12	8	5	0	-2	-4	-7	-7	-7
3690	4	1	2	2	2	1	0	2	4	5	5	4230	-6	-6	-6	-4	-1	0	-1	-1	0
3700	-3	-2	0	4	9	15	18	24	29	33	33	4240	3	6	7	10	13	16	18	21	24
3710	39	45	50	54	56	60	65	69	70	70	70	4250	27	29	32	35	33	33	34	34	34
3720	70	70	71	74	73	71	69	68	67	67	67	4260	33	32	31	30	29	28	26	25	24

CONTINUED(S-2110 DOWN)

NO.	(1)	(2)	(3)	(4)	(5)	(6)	(7)	(8)	(9)	(10)
4270	24	24	23	22	20	18	17	15	15	15
4280	12	11	10	9	5	4	3	1	0	-1
4290	-2	-2	-2	-4	-7	-9	-10	-12	-16	-17
4300	-18	-19	-20	-20	-20	-19	-20	-21	-22	-24
4310	-25	-24	-25	-27	-29	-32	-33	-34	-37	-37
4320	-37	-36	-34	-33	-31	-32	-32	-32	-30	-31
4330	-30	-29	-29	-28	-25	-25	-25	-25	-28	-28
4340	-27	-25	-24	-24	-24	-25	-25	-25	-27	-27
4350	-27	-27	-25	-23	-22	-22	-20	-18	-16	-14
4360	-12	-11	-11	-10	-9	-10	-8	-7	-6	-2
4370	1	2	2	1	0	-2	-5	-9	-11	-15
4380	-16	-19	-19	-17	-18	-19	-19	-17	-14	-15
4390	-14	-12	-10	-8	-7	-6	-5	0	3	4
4400	5	7	11	13	14	16	17	15	13	12
4410	12	12	14	14	18	19	21	24	25	26
4420	27	27	28	28	29	30	30	29	28	27
4430	27	27	27	25	23	23	21	21	22	24
4440	26	29	30	30	31	33	34	33	34	34
4450	36	38	38	38	38	37	38	39	40	39
4460	39	40	40	39	40	40	39	37	34	34
4470	32	29	28	27	24	22	17	14	9	3
4480	0	-3	-7	-7	-8	-9	-9	-10	-11	-11
4490	-13	-14	-13	-11	-9	-7	-5	-4	-4	-4
4500	-6	-5	-5	-6	-6	-7	-9	-9	-11	-14
4510	-17	-19	-19	-19	-20	-21	-21	-19	-19	-17
4520	-13	-9	-5	0	3	4	3	5	6	10
4530	11	12	13	15	16	15	13	13	12	11
4540	12	13	13	10	9	8	5	4	4	4
4550	3	3	4	4	4	5	7	7	6	6
4560	4	2	0	-2	-4	-7	-10	-12	-12	-13
4570	-14	-13	-11	-13	-13	-11	-8	-7	-6	-8
4580	-9	-10	-11	-14	-15	-16	-18	-19	-18	-19
4590	-20	-20	-21	-22	-22	-22	-21	-21	-24	-24
4600	-24	-23	-22	-21	-20	-19	-18	-19	-21	-22
4610	-33	-34	-34	-34	-33	-32	-31	-30	-31	-33
4620	-28	-24	-25	-24	-22	-21	-19	-16	-13	-11
4630	-10	-7	-4	-5	-4	-2	-1	-2	-1	1
4640	4	4	5	8	7	6	4	4	4	4
4650	4	3	2	2	0	-3	-4	-4	-4	-4
4660	-8	-9	-8	-7	-7	-4	0	2	4	6
4670	10	14	16	19	19	17	14	13	14	14
4680	14	14	12	11	9	8	6	5	5	5
4690	3	2	1	0	-2	-4	-5	-5	-5	-5
4700	-10	-14	-18	-20	-21	-24	-25	-25	-22	-24
4710	-35	-35	-36	-35	-35	-35	-35	-35	-36	-36
4720	-31	-31	-29	-23	-19	-16	-15	-13	-11	-12
4730	-11	-8	-5	-4	-3	0	1	4	5	5
4740	5	5	5	6	8	9	10	10	12	14
4750	14	14	16	19	20	21	20	18	18	18
4760	17	16	15	14	12	9	6	4	2	0
4770	0	-1	-3	-4	-5	-5	-4	-4	-3	-2
4780	-4	-4	-4	-5	-5	-4	-4	-4	-3	-2
4790	-1	-2	0	3	7	9	11	13	18	18
4800	-18	-19	-22	-23	-25	-25	-25	-25	-27	-28

TO BE CONTINUED

CONTINUED(S-2110 DOWN)

NO.	(1)	(2)	(3)	(4)	(5)	(6)	(7)	(8)	(9)	(10)
4810	29	30	29	30	33	33	33	33	31	29
4820	29	27	24	20	18	16	15	13	9	6
4830	3	2	4	6	5	5	4	4	3	5
4840	4	4	4	3	-4	-4	-5	-6	-8	-11
4850	-13	-15	-13	-11	-10	-12	-13	-13	-12	-13
4860	-15	-15	0	-14	-14	-13	-12	-9	-5	-2
4870	-1	2	3	5	5	4	6	8	9	11
4880	13	12	12	10	9	9	8	9	8	8
4890	10	12	12	12	12	14	16	17	17	18
4900	19	21	23	21	21	23	23	23	20	21
4910	22	19	18	17	16	14	13	12	9	7
4920	6	5	3	3	2	1	1	2	4	4
4930	7	7	7	8	6	6	7	7	7	5
4940	-1	-2	-3	-6	-4	-5	-6	-6	0	-1
4950	-6	-8	-9	-9	-11	-13	-17	-20	-24	-26
4960	-28	-30	-31	-34	-40	-45	-56	-66	-86	-85
4970	-57	-59	-59	-56	-56	-59	-59	-57	-55	-55
4980	-55	-53	-50	-49	-47	-46	-44	-43	-40	-40
4990	-38	-35	-36	-35	-33	-31	-29	-29	-29	-28
5000	-26	-28	-29	-28	-27	-26	-26	-26	-25	-24
5010	-24	-23	-23	-24	-24	-23	-23	-23	-27	-27
5020	-24	-23	-21	-21	-19	-19	-18	-15	-13	-10
5030	-7	-4	-3	-2	0	4	5	6	7	10
5040	12	13	15	17	18	21	22	22	23	23
5050	24	26	27	28	27	24	27	24	21	19
5060	20	19	18	18	15	12	11	9	8	7
5070	5	2	1	0	0	-2	-3	-4	-5	-3
5080	-1	1	1	1	4	4	4	4	5	7
5090	22	24	27	29	32	36	39	44	45	45
5100	45	47	49	49	49	48	47	44	39	36
5110	37	37	35	35	33	33	34	33	33	31
5120	27	25	23	21	20	16	14	11	6	1
5130	-1	-4	-7	-7	-9	-11	-11	-11	-12	-14
5140	-12	-12	-13	-15	-14	-14	-15	-15	-14	-12
5150	-12	-12	-10	-9	-8	-4	-3	0	2	5
5160	7	10	12	15	17	20	22	26	30	35
5170	35	36	36	37	39	38	39	40	40	37
5180	36	37	35	32	31	30	29	27	24	24
5190	22	19	17	13	11	8	4	1	-1	-3
5200	-5	-7	-7	-8	-10	-12	-15	-18	-25	-25
5210	-24	-27	-30	-32	-32	-33	-35	-37	-39	-40
5220	-42	-42	-42	-42	-42	-42	-42	-42	-41	-41
5230	-40	-39	-35	-33	-29	-24	-24	-24	-24	-24
5240	-3	0	1	3	5	6	9	12	14	15
5250	16	18	18	19	20	20	18	16	15	15
5260	14	14	15	14	14	13	14	15	15	16
5270	18	20	19	17	16	14	13	13	15	16
5280	14	15	15	15	15	12	8	5	2	-1
5290	-5	-8	-10	-11	-15	-16	-17	-16	-19	-18
5300	-16	-16	-17	-20	-21	-21	-21	-22	-22	-22
5310	-22	-22	-22	-22	-21	-21	-21	-22	-22	-22
5320	-25	-26	-28	-31	-33	-36	-37	-34	-34	-36
5330	-31	-30	-28	-26	-25	-23	-20	-19	-20	-17
5340	-14	-13	-12	-10	-8	-6	-5	-1	0	0

TO BE CONTINUED

CONTINUED(S-2110 DOWN)

CONTINUED(S-2110 DOWN)

NO.	(1)	(2)	(3)	(4)	(5)	(6)	(7)	(8)	(9)	(10)
5350	0	1	4	5	4	5	5	5	6	7
5360	8	9	10	11	13	11	9	9	9	8
5370	8	9	9	10	10	12	12	9	10	10
5380	8	9	9	10	10	10	9	9	10	13
5390	10	9	10	12	12	14	16	13	9	9
5400	14	14	12	12	12	14	16	10	13	9
5410	7	6	5	3	0	-2	-4	-6	-7	-7
5420	-6	-7	-6	-6	-3	-9	-13	-15	-15	-15
5430	-19	-22	-23	-24	-24	-22	-20	-17	-14	-12
5440	-11	-9	-7	-6	-4	-2	-3	-4	-3	-1
5450	0	2	5	5	7	11	15	15	14	13
5460	12	12	13	12	12	11	9	7	11	7
5470	5	5	4	0	-1	-4	-5	-7	-11	-12
5480	-15	-20	-19	-16	-19	-20	-23	-25	-24	-22
5490	-22	-21	-19	-17	-14	-12	-10	-9	-7	-3
5500	-1	1	6	6	6	10	15	21	25	25
5510	26	27	28	31	33	35	39	39	35	34
5520	36	36	34	33	34	36	37	38	37	36
5530	37	33	33	34	33	31	29	28	27	27
5540	26	25	24	23	20	17	16	14	12	10
5550	9	8	8	8	4	3	1	-1	-4	-5
5560	-7	-10	-11	-12	-12	-12	-12	-13	-16	-17
5570	-17	-21	-22	-22	-24	-24	-24	-24	-24	-25
5580	-26	-26	-25	-24	-23	-22	-21	-18	-15	-13
5590	-12	-11	-9	-7	-8	-9	-8	-5	-4	-4
5600	-4	-2	0	2	2	0	0	2	4	4
5610	4	4	5	6	8	8	7	6	5	5
5620	3	0	0	-2	-5	-5	-4	-4	-5	-5
5630	-8	-10	-9	-10	-8	-7	-8	-10	-9	-6
5640	-5	-5	-5	-5	0	0	2	0	0	0
5650	2	5	5	5	5	7	9	11	14	15
5660	16	18	18	20	22	24	25	26	27	26
5670	24	25	24	21	19	18	17	16	15	15
5680	14	12	11	8	7	7	6	5	5	5
5690	4	3	2	-1	-6	-8	-8	-9	-10	-11
5700	-11	-11	-10	-10	-10	-11	-13	-14	-16	-17
5710	-14	-12	-13	-13	-11	-8	-6	-7	-7	-7
5720	-5	-7	-6	-5	-2	-2	-2	-4	-2	-1
5730	-1	-2	-4	-4	-5	-6	-5	-6	-6	-5
5740	-6	-7	-7	-8	-9	-8	-9	-10	-9	-8
5750	-8	-6	-1	0	1	3	5	5	5	7
5760	9	10	11	14	16	17	19	21	22	22
5770	21	21	22	23	24	24	24	23	21	20
5780	20	19	17	15	14	14	13	11	8	7
5790	6	5	5	2	0	-2	-3	-5	-6	-7
5800	-8	-10	-11	-10	-9	-9	-9	-8	-7	-7
5810	-9	-11	-14	-14	-11	-12	-11	-10	-9	-9
5820	-7	-6	-5	-4	-2	-1	0	2	5	4
5830	3	3	4	2	1	0	0	0	0	0
5840	0	0	0	0	1	2	2	3	1	0
5850	0	1	2	0	-1	-3	-4	-3	-2	-3
5860	-4	-2	0	0	1	2	1	0	-1	-1
5870	-1	0	0	-1	2	-2	-1	-1	-3	-3
5880	-2	0	0	2	1	0	0	1	3	3

TO BE CONTINUED

END

RECORD = S-2111 COMPONENT = S03E STATION = SHINAGAWA-S
 DATE AND TIME = 1987-12-17-11-08 TOTAL NUMBER OF DATA = 5850
 SAMPLING INTERVAL = 0.010 (SEC) SCALE = 0.10000
 SIGNAL = GR. ACC. CONNECTION POINT IN DATA NUMBER = 3041, 5850.

CONTINUED(S-2111 S03E)

NO.	(1)	(2)	(3)	(4)	(5)	(6)	(7)	(8)	(9)	(10)
0	45	66	66	66	47	47	48	49	50	50
10	51	51	51	51	50	49	48	46	42	38
20	34	28	20	12	5	0	-7	-13	-20	-27
30	-37	-47	-56	-66	-75	-82	-90	-94	-97	-99
40	-99	-98	-95	-92	-84	-76	-59	-42	-23	-5
50	10	26	38	51	63	74	83	89	94	90
60	82	68	55	44	38	34	32	29	27	23
70	13	2	8	-12	-14	-15	-14	-12	-8	-6
80	15	-7	-13	-27	-41	-56	-64	-66	-61	-48
90	-30	-16	-6	-3	-5	-15	-32	-54	-78	-95
100	-104	-93	-64	-25	6	29	44	53	56	62
110	54	51	55	64	80	94	100	97	80	60
120	53	20	-14	-42	-55	-61	-63	-60	-50	-36
130	-21	-12	-10	-12	-15	-23	-31	-33	-29	-17
140	-1	14	30	43	51	58	62	62	60	56
150	53	48	43	36	24	5	-15	-37	-60	-77
160	-85	-84	-79	-73	-66	-61	-57	-54	-54	-57
170	-66	-78	-89	-95	-96	-94	-84	-70	-55	-41
180	-27	-7	20	46	69	82	85	84	83	79
190	74	73	78	88	107	130	150	171	170	170
200	161	148	128	103	75	65	43	-2	-30	-44
210	-56	-65	-74	-85	-99	-109	-117	-122	-127	-138
220	-158	-182	-193	-193	-180	-154	-119	-78	-38	-1
230	25	44	60	72	76	80	83	86	96	113
240	132	145	151	155	155	150	141	128	109	83
250	46	2	-32	-56	-71	-77	-74	-67	-62	-61
260	-69	-82	-93	-95	-84	-52	-16	9	20	21
270	13	-3	-25	-50	-71	-83	-86	-80	-68	-55
280	-39	-22	-6	1	1	0	-2	-8	-13	-12
290	-7	37	75	106	128	140	141	132	111	111
300	83	51	15	-8	-17	-20	-21	-23	-28	-38
310	-30	-41	-48	-51	-54	-54	-54	-49	-35	-13
320	7	22	24	17	26	34	45	64	88	118
330	-21	0	18	26	26	14	-4	-20	-35	-44
340	-43	-32	-16	3	23	40	49	52	51	40
350	22	9	4	5	13	26	39	47	49	46
360	35	5	6	-5	-17	-25	-24	-17	-4	13
370	34	53	66	71	69	58	38	17	0	-24
380	-50	-69	-77	-81	-82	-78	-71	-66	-65	-71
390	-85	-95	-100	-93	-78	-39	2	34	47	68
400	43	32	22	12	7	-1	4	16	16	16
410	28	37	42	47	50	49	48	46	39	26
420	8	-7	-12	-8	-3	5	22	42	56	62
430	60	48	23	-10	-43	-70	-90	-102	-108	-107
440	-100	-87	-69	-53	-39	-29	-22	-19	-17	-18
450	-24	-27	-27	-25	-20	-16	-8	-2	5	16
460	26	30	30	28	23	20	15	13	17	17
470	18	19	14	10	-6	-10	-5	17	19	19
480	26	31	35	35	29	28	22	16	5	5
490	-7	-17	-24	-25	-23	-18	-11	-4	-2	-1
500	-2	-6	-12	-19	-28	-37	-43	-47	-46	-41
510	-30	-17	-10	-17	-26	-34	-41	-46	-51	-58
520	22	30	34	35	32	27	21	18	17	21
530	30	41	49	53	56	58	57	56	52	48
540	44	39	34	26	20	12	-6	-13	-15	-12
550	-6	-4	-3	-12	-20	-27	-36	-49	-62	-76
560	-90	-100	-104	-98	-100	-94	-87	-81	-76	-72
570	12	9	6	0	-3	-8	-10	-8	-3	7
580	24	40	53	60	63	63	59	50	37	21
590	5	-7	-16	-22	-23	-21	-16	-9	-4	-4
600	-4	-17	-34	-41	-46	-48	-45	-38	-4	-4
610	-26	-12	0	5	7	3	-5	-14	-21	-26
620	-31	-33	-33	-29	-16	4	31	58	86	105
630	114	115	102	73	40	6	-15	-25	-35	-31
640	-15	-15	-21	-39	-74	-96	-100	-93	-71	-55
650	-6	10	18	21	22	21	19	20	18	16
660	16	16	16	17	20	23	24	26	28	25
670	20	16	13	12	11	11	11	11	11	8
680	-1	-6	-17	-33	-53	-80	-105	-121	-129	-132
690	-127	-119	-111	-102	-96	-80	-94	-94	-96	-102
700	-110	-118	-127	-138	-142	-137	-122	-90	-52	-19
710	3	14	18	15	6	3	-10	-11	-7	4
720	19	31	51	78	104	120	125	129	132	135
730	143	158	183	215	233	234	227	208	178	139
740	91	46	4	-38	-74	-94	-97	-104	-98	-66
750	-48	-37	-33	-38	-54	-85	-118	-136	-137	-124
760	103	-76	-51	-37	-35	-44	-65	-97	-134	-164
770	-182	-194	-201	-205	-205	-204	-203	-198	-187	-169
780	-143	-115	-92	-74	-69	-77	-100	-135	-170	-200
790	-217	-223	-223	-214	-194	-176	-167	-160	-161	-167
800	-178	-189	-196	-192	-167	-123	-80	0	45	73
810	84	96	118	152	218	308	409	494	552	577
820	580	571	555	538	518	483	423	351	271	188
830	120	67	33	15	7	0	-13	-48	-112	-185
840	-251	-311	-365	-404	-428	-468	-666	-679	-483	-473
850	-629	-340	-225	-82	83	223	314	398	476	524
860	549	564	566	555	541	525	504	467	415	347
870	259	151	34	-89	-199	-279	-359	-426	-482	-534
880	-578	-662	-662	-608	-731	-748	-758	-757	-744	-721
890	-692	-682	-632	-602	-574	-538	-486	-415	-328	-210
900	-49	135	301	443	552	654	705	727	767	767
910	790	818	845	885	935	981	1031	1077	1123	1143
920	1137	1099	1024	942	853	736	628	537	498	478
930	449	389	307	205	92	-32	-204	-390	-531	-667
940	-751	-793	-809	-807	-784	-744	-696	-649	-601	-571
950	-560	-562	-576	-604	-631	-651	-665	-663	-638	-584
960	-514	-427	-324	-206	-99	-1	85	205	379	536
970	645	756	787	784	756	689	606	524	451	392
980	354	330	311	291	265	235	187	123	64	12
990	-24	-42	-51	-82	-80	-106	-148	-208	-277	-359
1000	-447	-512	-543	-538	-560	-561	-557	-554	-551	-550
1010	-547	-537	-523	-508	-491	-474	-456	-426	-383	-325
1020	-255	-184	-116	-51	1	37	59	74	81	88

TO BE CONTINUED

TO BE CONTINUED

CONTINUED (S-2111 SO3E)

CONTINUED (S-2111 SO3E)

NO.	(1)	(2)	(3)	(4)	(5)	(6)	(7)	(8)	(9)	(10)
1030	100	116	136	168	212	280	360	428	468	484
1040	478	469	402	351	310	291	291	302	315	319
1050	309	268	196	116	59	17	2	14	55	110
1060	160	191	206	199	164	128	82	34	-12	-58
1070	103	149	-183	-206	-216	-211	-185	-134	-70	-16
1080	13	23	23	10	-22	-75	-136	-195	-257	-317
1090	363	-392	-401	-398	-387	-370	-350	-331	-308	-278
1100	-244	-206	-163	-107	-40	16	67	106	129	140
1110	146	155	165	177	192	205	220	238	258	273
1120	279	275	249	196	132	75	51	0	-20	-37
1130	-55	-70	-80	-85	-81	-71	-56	-26	17	65
1140	107	141	161	169	174	182	206	251	309	356
1150	376	367	328	269	213	159	107	64	27	-9
1160	-49	-87	-116	-149	-145	-134	-121	-108	-99	-99
1170	-94	-94	-94	-94	-94	-94	-107	-131	-166	-206
1180	-245	-271	-281	-277	-261	-233	-199	-164	-131	-98
1190	-61	-31	99	7	19	28	55	41	62	91
1200	124	153	176	187	181	158	120	86	71	71
1210	91	124	164	202	216	212	182	137	85	27
1220	-29	-82	-134	-181	-223	-255	-270	-266	-235	-195
1230	-157	-128	-116	-119	-133	-159	-195	-229	-254	-273
1240	-288	-294	-294	-294	-295	-294	-292	-288	-275	-248
1250	-200	-131	-45	67	140	212	245	253	252	248
1260	250	265	304	390	508	590	624	653	623	579
1270	512	436	361	298	248	210	184	172	166	160
1280	152	138	111	66	-3	-76	-134	-189	-250	-301
1290	-341	-370	-395	-416	-425	-423	-411	-380	-322	-259
1300	-202	-153	-117	-92	-77	-67	-58	-49	-38	-31
1310	-27	-29	-39	-58	-77	-91	-93	-80	-73	6
1320	55	95	116	117	95	51	-29	-90	-177	-251
1330	-314	-358	-375	-373	-354	-320	-275	-227	-179	-135
1340	-96	-60	-27	3	27	40	46	46	46	48
1350	55	68	93	138	191	243	288	321	342	351
1360	349	335	310	282	251	222	194	173	156	142
1370	127	99	58	11	-30	-77	-121	-159	-180	-196
1380	-208	-211	-208	-194	-165	-125	-82	-50	-30	-20
1390	-21	-30	-48	-66	-83	-102	-124	-149	-179	-222
1400	-251	-255	-251	-186	-113	-28	51	119	172	207
1410	226	237	242	246	250	253	256	260	263	263
1420	258	248	230	203	166	125	88	59	35	14
1430	-4	-25	-53	-90	-134	-180	-217	-237	-241	-238
1440	-227	-215	-209	-209	-219	-239	-264	-288	-299	-298
1450	-283	-254	-211	-163	-111	-54	9	68	113	148
1460	178	188	186	178	161	133	98	59	26	-3
1470	-30	-51	-61	-62	-53	-26	12	65	135	202
1480	234	247	252	250	240	225	213	209	214	228
1490	244	260	271	270	251	213	161	91	12	-58
1500	-124	-174	-280	-363	-408	-450	-446	-428	-394	-354
1510	343	296	-206	-145	-87	-34	-9	-1	-2	5
1520	-9	-11	-9	8	35	74	117	162	218	267
1530	304	328	342	347	350	348	342	326	326	295
1540	250	182	124	61	-5	-64	-104	-124	-131	-127
1550	-117	-103	-92	-91	-100	-122	-155	-196	-238	-270
1560	-287	-296	-294	-271	-239	-207	-174	-137	-105	-83

TO BE CONTINUED

TO BE CONTINUED

CONTINUED(S-2111 SO3E)

CONTINUED(S-2111 SO3E)

NO.	(1)	(2)	(3)	(4)	(5)	(6)	(7)	(8)	(9)	(10)
2110	10	10	4	-16	-51	-86	-115	-142	-163	-176
2120	-183	-185	-181	-175	-143	-121	-103	-91	-83	-83
2130	-79	-78	-79	-79	-80	-76	-70	-62	-52	-52
2140	-39	-23	3	19	64	65	81	93	103	109
2150	100	106	101	93	80	68	61	57	60	74
2160	90	108	122	131	129	123	114	98	76	76
2170	52	20	-15	-48	-102	-117	-124	-122	-115	-115
2180	-104	-93	-84	-79	-80	-83	-104	-118	-139	-139
2190	-160	-179	-196	-206	-210	-209	-200	-182	-160	-139
2200	-115	-95	-79	-61	-46	-33	-20	-6	8	27
2210	55	89	126	161	195	227	253	288	296	296
2220	297	289	272	243	204	168	139	94	75	75
2230	61	48	33	14	-9	-36	-70	-104	-133	-155
2240	-170	-197	-204	-208	-212	-214	-219	-223	-213	-213
2250	-225	-223	-218	-208	-187	-164	-145	-103	-57	-174
2260	24	60	89	109	121	131	142	152	164	180
2270	193	202	206	202	186	161	127	97	72	59
2280	54	50	47	46	43	28	0	-37	-75	-75
2290	-107	-132	-155	-178	-195	-202	-199	-187	-168	-126
2300	-74	-19	35	78	101	111	115	113	108	101
2310	93	83	73	61	46	31	19	8	-2	-14
2320	-28	-49	-73	-92	-106	-115	-121	-119	-114	-105
2330	-87	-70	-60	-45	-26	-2	27	62	93	120
2340	150	168	185	206	215	215	208	192	174	174
2350	156	132	111	92	70	49	39	8	-14	-42
2360	-69	-92	-111	-124	-159	-131	-128	-114	-94	-80
2370	-73	-68	-67	-71	-76	-80	-85	-90	-88	-88
2380	-86	-79	-67	-52	-33	-12	9	23	29	31
2390	31	28	23	15	9	8	12	20	27	27
2400	32	38	42	44	45	47	52	64	67	67
2410	71	72	74	73	73	78	83	95	112	130
2420	160	182	188	193	192	183	166	146	139	114
2430	105	97	88	80	67	51	25	-15	-57	-97
2440	-133	-162	-186	-207	-224	-241	-257	-272	-286	-300
2450	-311	-317	-317	-308	-299	-282	-263	-238	-216	-196
2460	-177	-158	-140	-121	-97	-66	-35	-5	29	68
2470	112	152	172	179	182	184	185	179	176	176
2480	173	171	168	164	162	157	152	148	141	136
2490	135	133	129	121	112	103	93	76	53	26
2500	2	-22	-52	-72	-92	-116	-131	-142	-150	-154
2510	-154	-149	-140	-127	-108	-90	-77	-67	-63	-64
2520	-68	-75	-79	-81	-76	-60	-45	-15	16	46
2530	63	68	66	56	37	7	-25	-50	-68	-77
2540	-79	-74	-59	-37	-12	16	47	68	81	90
2550	94	96	97	99	101	105	107	105	96	79
2560	59	42	29	19	15	13	15	16	14	9
2570	-1	-14	-27	-38	-45	-49	-54	-52	-51	-50
2580	-47	-44	-39	-34	-26	-17	-8	4	20	35
2590	53	72	86	94	100	99	96	89	80	69
2600	58	44	30	17	10	8	7	6	4	2
2610	0	-4	-10	-16	-26	-37	-49	-61	-71	-77
2620	-80	-77	-72	-64	-56	-46	-34	-22	-18	-8
2630	7	29	52	69	88	109	127	141	154	164
2640	170	172	169	161	150	137	126	118	115	113

TO BE CONTINUED

TO BE CONTINUED

CONTINUED(S-2111 SO3E)

CONTINUED(S-2111 SO3E)

NO.	(1)	(2)	(3)	(4)	(5)	(6)	(7)	(8)	(9)	(10)
3190	67	66	62	56	50	43	36	28	18	9
3200	3	-4	-17	-34	-49	-63	-79	-94	-104	-110
3210	-114	-115	-110	-101	-92	-84	-73	-64	-55	-45
3220	-32	-18	-5	17	45	67	86	106	125	145
3230	3230	158	163	160	157	151	138	127	110	101
3240	85	80	75	68	62	55	48	42	34	25
3250	30	27	23	17	12	4	-7	-21	-35	-52
3260	-72	-90	-103	-112	-119	-125	-126	-127	-126	-126
3270	-119	-111	-104	-97	-88	-80	-74	-68	-58	-44
3280	-27	-12	3	20	39	59	80	97	108	112
3290	118	121	122	120	113	103	90	75	61	52
3300	43	35	29	28	29	30	28	24	20	18
3310	16	11	2	-1	-3	-3	-7	-13	-17	-24
3320	-35	-47	-58	-67	-73	-78	-79	-77	-76	-74
3330	-76	-75	-73	-70	-63	-54	-45	-34	-19	-4
3340	6	16	30	45	59	73	90	108	123	134
3350	166	155	159	159	154	145	134	121	106	94
3360	86	78	70	62	54	46	38	28	14	0
3370	-13	-31	-40	-59	-72	-85	-89	-88	-81	-71
3380	-102	-110	-115	-119	-121	-120	-120	-118	-113	-110
3390	-107	-102	-92	-81	-69	-51	-32	-17	-2	17
3400	36	43	44	49	50	48	44	38	27	13
3410	3	-2	-10	-17	-22	-30	-38	-47	-55	-61
3420	-63	-65	-66	-66	-66	-65	-58	-49	-40	-32
3430	-24	-17	-11	-5	0	9	23	38	53	72
3440	96	115	129	138	140	140	143	143	135	120
3450	103	88	76	62	50	42	39	40	41	42
3460	43	42	46	48	45	39	35	31	25	19
3470	12	3	-3	-10	-18	-26	-32	-45	-55	-62
3480	-82	-84	-86	-88	-84	-57	-50	-42	-35	-28
3490	-21	-13	-5	2	12	23	33	41	52	62
3500	69	75	82	88	93	96	96	97	97	91
3510	80	66	51	35	18	3	-6	-14	-21	-25
3520	-30	-37	-42	-49	-57	-64	-67	-68	-68	-68
3530	-65	-61	-57	-51	-46	-41	-38	-36	-34	-34
3540	-32	-32	-33	-37	-41	-45	-49	-51	-54	-56
3550	-53	-51	-50	-50	-51	-50	-51	-52	-49	-59
3560	-66	-13	0	17	36	53	66	80	96	109
3570	118	126	133	138	141	142	141	142	144	143
3580	141	139	135	134	132	127	120	110	98	84
3590	68	52	35	16	-2	-19	-36	-52	-64	-75
3600	-84	-90	-97	-106	-114	-120	-125	-130	-137	-141
3610	-143	-144	-146	-146	-144	-141	-135	-128	-119	-108
3620	-95	-82	-66	-50	-32	-15	6	29	49	70
3630	92	107	116	126	132	132	130	126	121	116
3640	110	103	95	89	75	45	18	-6	-34	-60
3650	-85	-107	-122	-132	-138	-141	-142	-142	-140	-134
3660	-127	-120	-111	-103	-92	-82	-73	-67	-61	-52
3670	-42	-33	-24	-16	-8	3	17	32	45	59
3680	74	86	95	103	110	116	122	129	135	141
3690	144	146	146	140	139	115	99	78	54	27
3700	0	-19	-41	-66	-93	-119	-144	-167	-191	-210
3710	-217	-218	-213	-200	-182	-167	-146	-117	-87	-61
3720	-36	-14	3	20	35	52	71	87	100	115

TO BE CONTINUED

TO BE CONTINUED

CONTINUED(S-2111 S03E)

NO.	(1)	(2)	(3)	(4)	(5)	(6)	(7)	(8)	(9)	(10)
4270	-24	-32	-38	-43	-48	-51	-55	-56	-57	-57
4280	-54	-48	-43	-33	-26	-19	-9	-2	-2	-4
4290	8	9	9	9	9	9	5	5	5	-9
4300	-16	-21	-25	-29	-32	-34	-36	-41	-47	-54
4310	-62	-69	-74	-79	-85	-88	-90	-92	-93	-91
4320	-90	-88	-85	-82	-78	-73	-67	-61	-54	-45
4330	-35	-26	-16	-7	0	11	23	34	43	50
4340	54	58	60	61	62	63	65	62	58	52
4350	53	47	41	35	27	20	14	9	3	0
4360	-2	-3	-5	-7	-7	-6	-6	-4	0	0
4370	6	15	21	25	29	33	34	34	33	33
4380	34	35	37	38	39	39	40	41	40	39
4390	38	37	35	31	25	20	15	9	2	-2
4400	-6	-10	-12	-12	-13	-13	-12	-9	-6	-4
4410	-2	0	2	6	10	13	15	14	10	4
4420	-2	-10	-21	-28	-35	-41	-44	-47	-47	-48
4430	-49	-50	-51	-51	-54	-56	-58	-58	-58	-58
4440	-58	-56	-51	-46	-41	-35	-28	-21	-16	-12
4450	-7	-5	-4	-2	0	2	3	1	2	4
4460	6	8	9	11	14	16	18	19	23	27
4470	29	30	31	33	38	41	43	45	46	47
4480	45	41	36	32	29	26	23	22	23	24
4490	27	29	30	31	30	31	28	24	21	17
4500	12	6	0	-3	-7	-12	-14	-18	-20	-23
4510	-26	-29	-29	-30	-30	-31	-31	-31	-32	-33
4520	-32	-32	-31	-27	-22	-20	-15	-10	-5	-2
4530	0	1	2	1	0	0	2	3	6	10
4540	15	18	20	23	25	27	28	29	32	37
4550	42	45	46	49	52	54	55	56	59	61
4560	62	61	61	60	58	54	47	40	34	29
4570	24	19	15	12	7	0	-6	-11	-15	-18
4580	-21	-23	-23	-21	-19	-16	-14	-12	-8	-6
4590	-4	-2	0	1	4	9	14	22	29	39
4600	49	57	62	67	69	69	69	68	63	59
4610	58	53	46	37	28	18	6	-5	-15	-29
4620	-41	-53	-63	-70	-77	-81	-84	-88	-92	-96
4630	-99	-101	-103	-103	-100	-97	-92	-86	-81	-74
4640	-67	-60	-54	-48	-43	-37	-30	-24	-18	-12
4650	5	9	18	23	28	34	40	44	44	48
4660	52	57	61	64	68	73	76	75	74	70
4670	64	56	48	39	29	19	11	5	0	0
4680	-4	-6	-7	-7	-8	-10	-12	-13	-13	-13
4690	-15	-13	-12	-10	-7	-5	-2	0	3	6
4700	9	10	11	11	11	11	11	11	11	11
4710	10	7	5	3	1	0	-3	-6	-7	-11
4720	-15	-19	-23	-25	-28	-32	-35	-36	-36	-36
4730	-35	-32	-28	-24	-20	-15	-8	-2	4	12
4740	17	21	24	28	29	28	26	23	18	14
4750	8	2	-3	-9	-14	-18	-23	-25	-26	-26
4760	-26	-26	-27	-28	-28	-27	-25	-21	-16	-11
4770	-7	-4	-2	0	4	7	9	13	16	20
4780	25	29	32	34	34	33	29	23	19	14
4790	10	8	8	9	8	4	0	-2	-5	-3
4800	-6	-9	-12	-15	-19	-24	-29	-34	-38	-40

TO BE CONTINUED

CONTINUED(S-2111 S03E)

NO.	(1)	(2)	(3)	(4)	(5)	(6)	(7)	(8)	(9)	(10)
4810	-40	-38	-35	-31	-26	-19	-12	-6	-1	2
4820	6	9	11	14	16	16	18	20	23	27
4830	30	33	37	40	42	44	44	44	43	39
4840	34	27	21	15	8	1	-5	-14	-20	-27
4850	-32	-37	-46	-53	-58	-66	-74	-82	-88	-93
4860	-97	-99	-100	-98	-94	-89	-85	-82	-78	-74
4870	-70	-64	-58	-54	-50	-44	-40	-36	-30	-23
4880	-17	-11	-5	0	2	5	8	11	13	13
4890	16	19	22	25	28	30	31	33	35	37
4900	38	38	39	39	39	36	35	32	27	21
4910	14	5	-1	-7	-12	-16	-19	-21	-23	-23
4920	-22	-19	-17	-16	-14	-11	-7	-3	0	2
4930	4	7	8	8	8	8	8	8	8	8
4940	10	12	12	13	16	17	18	18	16	14
4950	11	11	10	8	6	4	0	-1	-3	-6
4960	-10	-13	-15	-17	-20	-22	-23	-25	-28	-30
4970	-32	-35	-37	-40	-42	-43	-45	-46	-45	-45
4980	-44	-41	-37	-35	-29	-24	-19	-13	-7	0
4990	5	11	16	20	24	30	37	42	47	53
5000	58	62	66	69	70	69	67	65	62	57
5010	54	49	44	38	33	26	17	11	6	2
5020	-2	-7	-10	-13	-12	-11	-11	-11	-12	-16
5030	-17	-21	-27	-35	-45	-56	-65	-75	-85	-93
5040	-84	-84	-81	-77	-70	-62	-55	-42	-32	-24
5050	-16	-8	0	5	9	11	14	17	20	21
5060	22	23	23	22	21	18	16	13	11	10
5070	7	3	0	-2	-4	-5	-6	-6	-7	-7
5080	18	21	22	22	22	21	18	13	16	16
5090	18	16	16	16	16	15	12	10	7	5
5100	16	16	16	16	16	15	12	10	8	5
5110	1	0	-2	-2	-2	-2	0	2	7	11
5120	13	17	20	26	30	34	39	45	48	49
5130	50	51	51	48	47	45	42	41	38	36
5140	32	28	24	18	12	8	3	-1	-6	-10
5150	-10	-13	-15	-16	-15	-15	-16	-17	-16	-14
5160	-12	-11	-8	-7	-7	-7	-6	-5	-3	-3
5170	-3	-1	1	3	6	8	9	11	12	12
5180	11	11	9	8	7	4	1	-2	-4	-8
5190	-12	-14	-14	-12	-9	-7	-4	-3	0	0
5200	1	1	0	-3	-6	-9	-13	-18	-22	-24
5210	-27	-30	-32	-36	-40	-41	-42	-42	-39	-41
5220	-34	-31	-26	-21	-15	-11	-8	-5	-3	-3
5230	1	0	2	4	7	10	13	17	22	26
5240	29	31	33	36	39	38	37	34	32	26
5250	29	28	24	21	19	18	18	18	18	19
5260	21	22	22	22	22	21	17	15	11	5
5270	0	-3	-4	-6	-7	-7	-6	-5	-3	-3
5280	1	7	14	21	27	33	39	43	44	45
5290	46	48	49	48	46	43	40	36	31	26
5300	23	20	18	15	13	12	11	8	4	1
5310	-1	-4	-7	-9	-13	-15	-18	-20	-21	-21
5320	-19	-18	-15	-13	-12	-12	-11	-10	-11	-11
5330	-10	-11	-12	-12	-12	-12	-11	-8	-7	-5
5340	3	8	13	17	19	22	22	22	21	20

TO BE CONTINUED

CONTINUED(S-2111 SOJSE)

RECORD = S-2111 COMPONENT = ED3N STATION = SHINAGAWA-S
DATE AND TIME = 1987-12-17-11-08 TOTAL NUMBER OF DATA = 5850
SAMPLING INTERVAL = 0.010 (SEC) SCAL = 0.10000
SIGNAL = GR. ACC. CONNECTION POINT IN DATA NUMBER = 3096, 5850.

STATION = SHINAGAWA-S
TOTAL NUMBER OF DATA = 5850
SCAL = 0.10000

NO.	(1)	(2)	(3)	(4)	(5)	(6)	(7)	(8)	(9)	(10)
5350	18	15	11	7	3	-1	-4	-7	-11	-16
5360	-21	-26	-31	-34	-37	-40	-42	-43	-43	-41
5370	-40	-38	-36	-35	-33	-30	-27	-25	-24	-23
5380	-21	-19	-17	-15	-14	-11	-9	-6	-3	-1
5390	1	4	7	10	11	12	13	12	12	13
5400	14	16	20	22	25	27	31	35	37	38
5410	39	41	44	47	47	46	44	44	44	41
5420	39	39	38	37	37	36	32	30	28	24
5438	20	18	16	13	10	7	4	1	-1	-3
5440	-5	-8	-10	-13	-15	-18	-22	-26	-29	-33
5450	-37	-41	-45	-49	-50	-52	-52	-49	-44	-42
5460	-45	-43	-39	-36	-32	-28	-25	-23	-23	-24
5470	-25	-20	-18	-16	-14	-12	-10	-8	-6	-4
5488	-25	-20	-17	-11	-3	4	14	20	27	34
5490	41	46	50	56	61	66	67	69	69	72
5500	73	76	77	76	73	67	61	52	43	43
5510	34	26	18	8	0	-6	-12	-18	-22	-27
5520	-33	-38	-42	-46	-50	-53	-55	-56	-55	-55
5530	-55	-55	-55	-54	-53	-51	-49	-44	-37	-37
5540	-31	-27	-23	-18	-13	-7	-2	1	5	2
5550	13	15	16	15	13	12	9	5	2	2
5560	3	3	1	1	1	0	0	-1	-4	-5
5570	-5	-3	-4	-5	-5	-3	-3	-5	-5	-3
5580	-2	-1	0	4	7	10	12	13	15	15
5590	15	13	13	14	15	15	15	18	19	19
5600	18	16	14	12	9	6	4	1	0	-2
5610	-4	-6	-9	-11	-14	-17	-22	-27	-32	-37
5620	-40	-41	-40	-40	-41	-42	-40	-39	-37	-35
5630	-34	-32	-28	-25	-23	-20	-17	-15	-11	-9
5640	-8	-7	-4	-3	-2	2	7	7	6	6
5650	7	7	7	6	7	7	7	7	7	3
5660	-1	-3	-5	-7	-7	-10	-12	-14	-17	-19
5670	-24	-28	-32	-33	-37	-38	-37	-39	-39	-37
5680	-37	-33	-28	-21	-17	-12	-6	1	10	19
5690	27	35	43	50	55	58	61	63	64	63
5700	61	59	57	55	52	47	39	32	25	16
5710	7	0	-5	-11	-17	-23	-29	-35	-39	-43
5720	-45	-46	-47	-51	-54	-54	-53	-52	-49	-45
5730	-47	-43	-39	-33	-27	-18	-12	-7	-3	-3
5740	2	9	12	14	19	23	27	30	34	38
5750	44	47	48	50	52	51	50	47	44	41
5760	37	32	28	23	20	18	14	14	13	11
5770	0	-2	-4	-7	-11	-14	-16	-19	-22	-23
5780	-24	-25	-25	-24	-22	-21	-26	-24	-22	-22
5790	-22	-21	-20	-19	-16	-12	-9	-8	-5	-2
5800	0	2	6	10	12	14	17	20	22	25
5810	27	31	32	35	37	37	36	34	28	28
5820	22	18	16	12	7	4	2	-2	-7	-6
5830	-8	-11	-14	-17	-17	-16	-18	-17	-16	-18
5840	-17	-17	-16	-13	-9	-8	-6	-5	-4	-3

END

TO BE CONTINUED

CONTINUED (S-2111 E03N)

NO.	(1)	(2)	(3)	(4)	(5)	(6)	(7)	(8)	(9)	(10)
490	103	105	99	80	60	39	26	22	29	41
500	50	54	54	46	30	12	0	-8	-35	-81
510	-70	-41	-40	-52	-62	-70	-77	-80	-78	-75
520	-72	-71	-70	-69	-66	-55	-35	-15	0	12
530	19	22	20	16	11	0	0	-3	-5	-5
540	-5	-3	-3	-4	-4	-12	-20	-28	-33	-34
550	-22	10	44	72	94	112	118	114	100	85
560	71	62	59	58	65	79	92	108	127	137
570	141	133	108	176	39	-1	-43	-79	-98	-91
580	-109	-114	-113	-105	-98	-93	-91	-93	-97	-101
590	-102	-102	-97	-84	-59	-28	0	19	30	34
600	30	20	5	-6	-11	-7	16	56	93	125
610	141	136	117	87	46	12	-5	-17	-34	-49
620	-73	-102	-134	-180	-200	-224	-225	-203	-178	-160
630	-134	-103	-58	-17	15	53	97	140	183	212
640	245	289	291	288	266	240	223	210	211	214
650	219	214	191	171	127	81	20	-10	-45	-81
660	-110	-133	-124	-94	-49	-11	27	68	85	73
670	48	24	3	-14	-29	-40	-41	-36	-30	-27
680	-32	-44	-54	-63	-67	-53	-19	23	69	119
690	161	183	178	143	97	70	45	17	12	12
700	7	2	-4	-15	-26	-43	-65	-76	-76	-80
710	-102	-108	-127	-152	-184	-220	-240	-239	-199	-137
720	-102	-60	-16	19	55	86	163	144	134	126
730	90	69	37	16	-28	-79	-107	-133	-137	-127
740	-68	-20	6	57	86	103	105	106	95	72
750	52	33	13	4	12	29	46	66	86	98
760	97	77	47	21	-45	-29	-43	-48	-44	-37
770	-27	-9	13	42	72	100	132	163	162	138
780	112	91	95	115	144	176	208	224	224	196
790	157	125	101	84	69	70	87	107	133	137
800	131	118	90	59	44	-10	-78	-102	-131	-186
810	-278	-348	-419	-459	-498	-529	-542	-540	-518	-488
820	-464	-444	-433	-399	-360	-294	-200	-112	-47	31
830	145	259	368	486	556	573	550	497	430	357
840	399	259	227	210	198	171	144	110	35	-47
850	-169	-169	-169	-308	-346	-389	-437	-488	-516	-569
860	-355	-356	-352	-309	-438	-356	-257	-136	-17	90
870	179	243	314	342	388	450	514	597	680	785
880	855	919	956	960	966	948	893	842	795	751
890	701	603	515	428	333	233	145	24	-97	215
900	-334	-428	-515	-580	-628	-661	-679	-683	-685	-684
910	-880	-677	-663	-637	-613	-600	-592	-583	-569	-569
920	-560	-529	-499	-431	-373	-263	-119	90	115	208
930	300	410	400	366	351	280	232	217	255	301
940	329	371	394	395	389	363	314	257	206	161
950	128	96	57	17	-15	-1	31	65	116	163
960	176	201	208	221	229	249	252	219	159	117
970	47	-17	-66	-95	-116	-126	-118	-109	-105	-105
980	-112	-135	-188	-255	-332	-430	-509	-563	-586	-574
990	-526	-452	-362	-272	-192	-137	-96	-69	-47	-15
1000	33	99	177	279	366	414	440	452	443	420
1010	393	365	344	348	381	438	515	591	649	677
1020	677	651	605	534	447	348	242	136	48	-12

TO BE CONTINUED

CONTINUED (S-2111 E03N)

NO.	(1)	(2)	(3)	(4)	(5)	(6)	(7)	(8)	(9)	(10)
1030	-58	-84	-96	-99	-99	-107	-132	-177	-244	-343
1040	-452	-552	-647	-727	-780	-799	-783	-745	-693	-620
1050	-534	-442	-348	-254	-172	-97	-29	33	70	82
1060	81	68	45	21	8	8	28	28	166	281
1070	395	463	511	535	539	527	503	464	416	363
1080	318	268	200	120	42	-31	-98	-147	-180	-204
1090	-225	-253	-293	-342	-403	-462	-520	-580	-616	-632
1100	-622	-584	-502	-384	-251	-108	25	108	138	137
1110	126	113	106	121	165	238	312	357	371	354
1120	311	256	205	169	166	184	206	228	235	209
1130	151	63	-23	-99	-159	-205	-234	-245	-242	-223
1140	-189	-131	-61	63	163	237	277	277	253	209
1150	154	98	50	14	-8	-28	-47	-62	-71	-76
1160	-77	-77	-77	-82	-100	-127	-157	-186	-213	-242
1170	-278	-312	-339	-353	-352	-330	-280	-203	-110	-12
1180	87	172	221	235	229	204	165	127	102	91
1190	89	94	102	106	100	76	53	-21	-75	-109
1200	-122	-120	-110	-98	-90	-92	-102	-117	-126	-130
1210	-126	-111	-91	-78	-71	-70	-69	-61	-40	8
1220	75	139	185	209	216	216	210	206	206	212
1230	221	228	231	236	238	237	233	219	197	173
1240	152	133	110	83	50	10	-32	-74	-110	-134
1250	-144	-142	-125	-91	-54	-22	1	9	1	-20
1260	-48	-72	-85	-82	-59	-19	26	60	70	64
1270	45	16	-28	-76	-111	-133	-142	-139	-122	-98
1280	-73	-41	-16	-6	-1	-4	-14	-25	-35	-44
1290	-50	-60	-90	-134	-189	-260	-308	-333	-346	-349
1300	-340	-327	-313	-301	-293	-285	-282	-226	-186	-136
1310	-79	-38	-16	-7	-4	-5	5	2	8	31
1320	69	114	148	168	179	187	197	215	239	272
1330	305	332	350	361	365	362	356	347	334	314
1340	292	266	230	189	155	122	82	39	-5	-55
1350	-121	-182	-235	-297	-343	-367	-373	-363	-333	-287
1360	-245	-218	-208	-211	-224	-248	-278	-301	-307	-300
1370	-247	-182	-94	-2	61	102	133	162	199	249
1380	317	383	435	471	494	510	519	520	512	482
1390	457	408	347	269	199	129	65	-1	-61	-113
1400	-138	-194	-223	-245	-263	-278	-290	-307	-325	-340
1410	-349	-349	-332	-297	-250	-207	-177	-163	-160	-165
1420	-177	-195	-214	-228	-233	-232	-218	-186	-158	-145
1430	50	138	206	234	241	240	234	224	216	214
1440	219	232	245	252	254	252	245	237	233	233
1450	235	238	241	241	237	230	216	194	176	157
1460	138	123	113	104	96	91	85	77	71	74
1470	92	132	183	228	272	308	326	328	310	275
1480	221	161	89	10	-77	-155	-233	-318	-385	-446
1490	-487	-511	-522	-517	-498	-455	-415	-384	-360	-343
1500	-335	-335	-343	-356	-366	-369	-356	-319	-261	-188
1510	109	228	321	36	24	5	-13	-21	-2	54
1520	135	228	326	419	464	474	454	406	340	265
1530	193	127	55	-4	-60	-110	-136	-145	-142	-126
1540	-93	-34	18	60	96	124	137	125	96	96
1550	49	8	-20	-37	-44	-37	-15	19	54	87
1560	113	129	141	148	148	146	141	124	95	58

TO BE CONTINUED

	(1)	(2)	(3)	(4)	(5)	(6)	(7)	(8)	(9)	(10)
1570	17	-34	-103	-166	-206	-225	-228	-210	-160	-64
1580	52	150	240	319	366	382	377	355	326	294
1590	267	245	227	211	195	170	133	88	39	-6
1600	-52	-102	-166	-238	-352	-404	-471	-520	-559	-582
1610	-602	-615	-624	-626	-624	-618	-599	-556	-492	-417
1620	-338	-251	-168	-89	0	61	85	100	112	123
1630	134	159	197	239	277	311	341	355	362	364
1640	303	361	360	364	372	381	385	380	364	337
1650	304	271	246	231	223	220	220	217	206	182
1668	152	116	79	49	20	-17	-59	-95	-121	-138
1670	-144	-144	-138	-129	-122	-120	-120	-123	-128	-138
1680	-144	-128	-128	-134	-150	-173	-196	-217	-233	-242
1690	-241	-234	-205	-179	-151	-123	-91	-45	9	9
1700	64	107	159	204	225	230	224	201	155	88
1710	8	-75	-128	-152	-158	-154	-136	-102	-15	15
1720	17	39	51	57	61	63	68	79	98	124
1730	147	160	162	150	114	59	-5	-61	-93	-101
1740	-95	-76	-42	4	54	91	108	110	94	60
1750	18	-23	-69	-118	-165	-204	-22	-237	-234	-215
1760	-181	-139	-95	-51	-30	-22	-24	-38	-63	-96
1770	1770	-142	-150	-153	-150	-141	-131	-120	-111	-102
1780	-95	-81	-50	-2	55	108	155	196	233	237
1790	240	232	210	178	141	100	63	33	12	1
1800	-1	4	4	13	23	32	41	48	55	64
1810	74	85	96	101	100	93	79	60	38	13
1820	-11	-37	-63	-91	-118	-144	-173	-202	-229	-260
1830	-293	-323	-349	-370	-383	-386	-376	-342	-288	-219
1840	-142	-55	38	116	160	191	212	223	225	221
1850	216	214	213	216	218	215	204	196	159	123
1860	85	51	14	-17	-51	-90	-140	-193	-237	-277
1870	-313	-332	-339	-337	-323	-295	-258	-230	-206	-180
1880	-150	-112	-63	-5	56	100	124	135	123	123
1890	108	94	86	84	90	107	130	152	173	190
1900	203	213	223	232	238	244	251	257	262	264
1910	261	251	232	198	149	91	34	-17	-60	-101
1920	-142	-180	-212	-241	-260	-270	-269	-253	-233	-185
1930	-144	-109	-82	-67	-60	-58	-61	-74	-91	-110
1940	-135	-159	-174	-180	-175	-152	-120	-72	-20	21
1950	49	59	58	47	22	-4	-27	-41	-47	-45
1960	-30	-2	26	46	59	66	68	63	55	47
1970	41	35	29	24	19	15	10	3	-8	8
1980	-24	-42	-58	-70	-75	-72	-60	-38	-10	3
1990	61	93	122	144	160	172	178	180	182	185
2000	186	187	183	174	157	134	105	69	28	28
2010	-15	-63	-102	-134	-166	-185	-191	-196	-194	-184
2020	-170	-154	-142	-137	-139	-145	-157	-168	-172	-171
2030	-166	-155	-139	-124	-113	-103	-93	-83	-72	-58
2040	-44	-31	-18	-6	1	9	24	49	82	126
2050	172	209	233	249	257	259	255	245	231	213
2060	191	167	143	118	94	68	40	-20	-49	-20
2070	-77	-96	-111	-128	-143	-154	-159	-161	-160	-159
2080	-137	-130	-140	-127	-113	-98	-82	-65	-49	-35
2090	-20	-5	8	24	33	39	43	46	49	53
2100	55	60	64	67	68	70	76	88	98	105

TO BE CONTINUED

TO BE CONTINUED

CONTINUED (S-2111 E03N)

NO.	(1)	(2)	(3)	(4)	(5)	(6)	(7)	(8)	(9)	(10)
2650	67	56	46	34	21	7	-6	-17	-25	-33
2660	-41	-50	-62	-76	-89	-100	-107	-111	-112	-105
2670	-90	-77	-64	-57	-53	-51	-56	-66	-83	-103
2680	-121	-131	-139	-144	-143	-134	-121	-104	-81	-56
2690	-35	-13	4	20	33	42	48	50	49	66
2700	42	35	27	16	0	-20	-44	-64	-76	-82
2710	-84	-80	-68	-52	-36	-25	-15	5	2	11
2720	18	25	30	34	38	41	43	48	54	54
2730	62	70	80	91	101	111	118	127	134	143
2740	148	150	149	144	131	114	94	71	50	33
2750	16	0	-13	-16	-6	-13	-47	-68	-77	-84
2760	-89	-92	-94	-97	-99	-99	-98	-98	-96	-94
2770	-90	-87	-85	-85	-83	-81	-81	-82	-82	-82
2780	-80	-73	-62	-50	-36	-21	-6	7	19	27
2790	31	34	33	31	30	30	34	42	52	64
2800	79	96	109	119	127	134	136	133	125	112
2810	94	76	59	42	27	17	14	10	6	1
2820	-2	-11	-22	-29	-35	-44	-50	-54	-60	-66
2830	-74	-80	-85	-92	-100	-105	-105	-100	-86	-65
2840	-40	-15	7	26	36	43	48	52	58	66
2850	77	89	95	98	98	93	84	73	59	41
2860	23	7	-8	-25	-46	-68	-89	-106	-119	-126
2870	-159	-129	-122	-110	-98	-80	-73	-68	-64	-64
2880	-58	-50	-39	-28	-20	-17	-16	-19	-23	-27
2890	-9	-27	-16	-1	9	19	31	40	48	55
2900	64	74	90	105	116	122	126	127	127	125
2910	123	123	123	124	124	116	101	87	69	69
2920	48	27	4	-16	-33	-46	-60	-76	-93	-111
2930	-127	-141	-153	-163	-170	-172	-176	-180	-183	-184
2940	-184	-182	-179	-175	-170	-164	-157	-150	-141	-141
2950	-129	-107	-68	-23	18	58	99	136	162	178
2960	189	201	211	221	231	238	242	242	236	219
2970	192	182	180	177	169	140	6	-26	-54	-78
2980	-102	-124	-135	-140	-141	-141	-136	-124	-110	-99
2990	-86	-74	-69	-66	-66	-67	-71	-73	-74	-83
3000	-88	-92	-96	-98	-96	-86	-71	-63	-49	-36
3010	73	106	132	147	151	150	144	132	120	109
3020	100	92	83	72	59	43	23	0	-22	-45
3030	-63	-77	-90	-100	-107	-111	-112	-109	-101	-85
3040	-63	-56	-48	-33	28	40	51	57	59	64
3050	69	73	72	72	74	75	75	82	92	103
3060	112	124	135	142	143	142	136	119	92	57
3070	16	-24	-74	-119	-148	-169	-180	-186	-192	-197
3080	-200	-199	-199	-201	-207	-211	-216	-218	-221	-217
3090	-57	-17	-17	-17	-17	-17	-17	-17	-17	-17
3100	-70	-67	-64	-63	-66	-72	-78	-85	-90	-95
3110	-98	-94	-88	-85	-88	-88	-88	-88	-88	-88
3120	132	145	149	149	145	136	125	114	104	96
3130	87	78	65	49	27	5	-12	-32	-56	-74
3140	-86	-97	-105	-110	-112	-110	-104	-90	-69	-44
3150	-14	9	30	43	49	56	62	66	67	69
3160	73	77	78	77	77	81	88	102	115	126
3170	133	140	145	146	137	118	92	58	21	-15
3180	-53	-85	-106	-119	-126	-129	-130	-131	-133	-135

TO BE CONTINUED

CONTINUED (S-2111 E03N)

NO.	(1)	(2)	(3)	(4)	(5)	(6)	(7)	(8)	(9)	(10)
3190	-136	-138	-140	-141	-143	-144	-146	-148	-149	-148
3200	-135	-102	-57	-12	31	67	97	122	141	159
3210	173	181	184	184	176	157	130	97	66	35
3220	4	-20	-39	-55	-65	-73	-79	-85	-91	-97
3230	-98	-101	-100	-95	-85	-66	-39	-10	12	32
3240	48	61	70	74	79	83	84	88	93	95
3250	98	99	99	94	90	81	67	53	39	25
3260	11	-2	-14	-23	-33	-47	-62	-77	-87	-94
3270	97	92	81	67	45	31	13	0	14	25
3280	31	33	30	24	15	5	-3	-11	-21	-32
3290	-40	-45	-51	-55	-60	-64	-67	-66	-60	-48
3300	-77	-72	-69	-67	-64	-62	-60	-58	-56	-54
3310	47	51	55	57	60	59	51	37	19	-1
3320	-22	-42	-58	-67	-69	-69	-65	-53	-40	-28
3330	-13	-1	10	22	36	51	66	84	102	118
3340	132	164	152	158	161	163	162	159	155	151
3350	148	166	145	143	139	132	118	104	90	71
3360	52	32	9	-12	-34	-53	-71	-87	-102	-112
3370	-116	-117	-119	-119	-116	-112	-108	-105	-100	-94
3380	-86	-77	-67	-56	-44	-31	-15	-3	6	17
3390	29	36	45	52	61	71	78	86	88	85
3400	77	70	60	48	36	26	16	6	-1	-8
3410	-14	-18	-20	-22	-23	-23	-24	-27	-33	-38
3420	-42	-45	-47	-48	-51	-56	-65	-76	-89	-102
3430	-115	-129	-140	-147	-150	-153	-154	-152	-145	-134
3440	-119	-99	-78	-58	-36	-14	2	16	30	43
3450	49	50	50	50	50	52	56	63	71	78
3460	88	96	102	105	103	94	82	62	46	30
3470	15	5	2	1	3	8	13	18	23	28
3480	33	37	41	47	52	55	60	64	67	66
3490	65	62	57	53	48	44	40	37	32	28
3500	22	14	6	-1	-9	-15	-19	-21	-19	-16
3510	-13	-11	-11	-11	-14	-19	-27	-35	-44	-53
3520	-62	-71	-80	-91	-100	-107	-111	-112	-110	-106
3530	-98	-88	-76	-65	-57	-49	-43	-39	-36	-34
3540	-33	-30	-26	-24	-22	-19	-15	-12	-9	-7
3550	-2	1	6	10	15	19	20	22	22	26
3560	28	33	40	47	54	63	71	78	82	82
3570	79	74	65	56	47	36	25	18	12	7
3580	5	5	9	11	11	13	14	15	16	19
3590	20	20	18	15	11	6	1	-3	-8	-13
3600	-19	-25	-30	-34	-37	-39	-42	-45	-48	-50
3610	-52	-53	-53	-53	-53	-51	-48	-41	-32	-20
3620	-7	2	11	18	19	15	8	-1	-11	-25
3630	-35	-44	-51	-56	-61	-65	-67	-70	-71	-69
3640	-68	-63	-57	-50	-42	-37	-34	-32	-33	-34
3650	-36	-37	-36	-34	-29	-22	-16	-12	-10	-9
3660	-11	-15	-21	-28	-35	-40	-42	-41	-37	-29
3670	-20	-8	5	22	37	49	60	68	72	73
3680	74	75	75	74	72	70	67	63	57	50
3690	43	36	32	30	29	28	27	29	29	28
3700	26	23	21	20	21	22	24	27	33	40
3710	46	47	48	48	44	37	29	19	9	1
3720	-3	-7	-9	-11	-12	-12	-12	-12	-12	-11

TO BE CONTINUED

NO.	(1)	(2)	(3)	(4)	(5)	(6)	(7)	(8)	(9)	(10)
3730	-11	-10	-5	-1	2	8	13	15	15	12
3740	6	0	-5	-11	-16	-18	-17	-14	-11	-11
3750	-7	-5	-3	-1	0	2	5	9	11	12
3760	11	10	6	2	-2	-7	-13	-19	-22	-25
3770	-30	-35	-40	-44	-49	-53	-57	-61	-63	-63
3780	-60	-59	-56	-52	-45	-34	-26	-16	-5	4
3790	13	18	21	24	29	34	40	46	51	56
3800	61	65	68	73	76	75	72	70	65	65
3810	58	53	47	41	38	31	26	25	23	21
3820	21	21	22	23	25	25	23	20	17	11
3830	3	-4	-12	-23	-33	-41	-49	-55	-60	-64
3840	-68	-72	-76	-76	-78	-81	-81	-80	-79	-77
3850	-74	-70	-66	-61	-53	-43	-33	-20	-7	4
3860	16	24	30	34	39	44	45	49	50	51
3870	49	48	45	40	34	28	20	11	3	-6
3880	-16	-26	-34	-41	-44	-48	-49	-48	-45	-39
3890	-33	-30	-26	-22	-20	-17	-15	-12	-11	-11
3900	-9	-9	-9	-7	-8	-8	-10	-12	-13	-15
3910	-17	-20	-22	-24	-24	-21	-17	-12	-12	-9
3920	0	8	16	28	42	57	70	82	90	98
3930	104	106	104	100	95	87	76	65	56	48
3940	41	33	27	21	16	9	1	-5	-12	-21
3950	-29	-35	-40	-46	-51	-56	-61	-65	-67	-71
3960	-73	-71	-67	-63	-56	-47	-36	-27	-19	-14
3970	-11	-8	-8	-9	-9	-9	-6	0	6	10
3980	12	7	-1	-13	-30	-49	-65	-80	-91	-96
3990	-100	-104	-104	-103	-99	-93	-83	-70	-58	-46
4000	-36	-29	-21	-13	-7	5	0	5	9	12
4010	16	22	28	36	47	59	71	80	103	114
4020	124	134	141	144	145	143	140	136	131	124
4030	114	102	91	75	64	53	41	32	27	23
4040	19	18	17	14	12	7	1	-5	-13	-21
4050	-30	-35	-41	-46	-51	-56	-60	-66	-70	-74
4060	-74	-72	-71	-68	-65	-64	-64	-63	-62	-61
4070	-61	-59	-56	-53	-50	-46	-40	-32	-22	-12
4080	-1	6	14	20	26	31	35	39	43	46
4090	49	52	54	55	53	47	41	33	24	14
4100	4	-5	-16	-25	-30	-33	-36	-37	-35	-33
4110	-23	-13	-10	-5	2	12	20	26	31	32
4120	28	23	19	12	3	-3	-11	-16	-19	-18
4130	-18	-16	-12	-6	0	8	16	21	28	37
4140	44	52	59	66	72	78	80	80	79	76
4150	72	68	65	64	62	60	60	60	59	57
4160	53	47	42	36	28	20	13	7	0	-5
4170	-14	-24	-34	-43	-52	-59	-65	-67	-66	-62
4180	-56	-49	-41	-33	-27	-20	-13	-7	-1	5
4190	13	19	25	29	34	36	40	47	53	59
4200	67	75	80	83	84	83	81	75	70	61
4210	51	44	35	27	17	8	-3	-16	-29	-38
4220	-50	-59	-65	-69	-74	-74	-74	-74	-75	-77
4230	-79	-80	-80	-78	-74	-72	-66	-56	-46	-36
4240	-24	-11	3	8	12	13	14	15	14	14
4250	13	13	11	8	3	-2	-8	-14	-22	-27
4260	-31	-35	-35	-31	-25	-19	-13	-6	-1	1

TO BE CONTINUED

NO.	(1)	(2)	(3)	(4)	(5)	(6)	(7)	(8)	(9)	(10)
4270	2	1	2	2	0	-1	0	3	9	18
4280	28	40	52	63	75	83	87	88	87	83
4290	78	73	70	63	56	47	40	35	28	22
4300	16	9	2	-4	-13	-20	-26	-32	-37	-40
4310	-42	-42	-43	-44	-45	-47	-48	-50	-51	-53
4320	-52	-50	-45	-36	-26	-16	-7	1	8	14
4330	9	7	4	1	1	3	6	10	12	10
4340	14	10	3	-3	-10	-15	-17	-16	-11	-4
4350	4	12	18	23	26	24	22	19	16	14
4360	13	12	9	6	3	2	1	0	-1	-2
4370	-6	-9	-15	-23	-29	-33	-38	-40	-43	-43
4380	-40	-36	-34	-30	-27	-24	-21	-19	-15	-13
4390	-11	-9	-6	-1	3	8	11	14	19	23
4400	27	30	32	33	35	38	42	43	43	41
4410	37	32	25	18	11	3	-4	-9	-13	-14
4420	-14	-11	-7	-3	0	5	11	16	20	22
4430	22	22	20	18	15	11	7	0	-5	-10
4440	-15	-19	-22	-26	-28	-29	-29	-29	-29	-28
4450	-28	-27	-26	-23	-20	-15	-11	-7	-3	1
4460	9	19	31	44	54	61	65	68	67	65
4470	60	54	48	43	38	32	29	27	23	17
4480	11	8	6	4	3	1	0	-1	-3	-6
4490	-11	-18	-25	-31	-35	-40	-44	-48	-50	-53
4500	-55	-57	-58	-58	-58	-57	-55	-52	-49	-43
4510	-37	-31	-26	-19	-12	-6	0	7	16	26
4520	33	38	45	48	50	52	55	55	55	55
4530	53	51	48	46	43	41	37	36	34	30
4540	32	30	28	27	25	22	19	15	12	5
4550	-1	-6	-10	-13	-14	-15	-17	-18	-18	-21
4560	-25	-30	-36	-43	-52	-61	-69	-76	-82	-84
4570	-84	-84	-83	-82	-83	-84	-87	-89	-92	-92
4580	-89	-86	-82	-77	-70	-62	-55	-46	-36	-25
4590	-13	-1	15	30	42	52	61	68	68	69
4600	68	68	68	67	66	66	64	62	59	57
4610	53	47	40	35	28	21	13	4	-3	-10
4620	-15	-21	-26	-31	-36	-41	-46	-49	-50	-51
4630	-51	-50	-48	-45	-41	-37	-34	-32	-30	-29
4640	-27	-23	-18	-13	-7	0	7	16	23	28
4650	33	38	41	44	45	45	44	42	39	35
4660	32	30	27	25	22	20	15	9	2	-5
4670	-16	-26	-36	-46	-55	-64	-73	-82	-91	-98
4680	-69	-67	-64	-60	-55	-46	-37	-27	-16	-5
4690	3	10	15	17	18	18	18	21	22	22
4700	37	42	46	50	51	49	44	38	32	25
4710	17	11	5	0	-4	-9	-13	-18	-23	-28
4720	-32	-36	-39	-41	-44	-48	-52	-57	-62	-67
4730	-70	-71	-72	-72	-71	-68	-65	-62	-57	-50
4740	-43	-37	-30	-22	-15	-8	0	4	10	15
4750	21	26	30	32	34	35	39	42	48	56
4760	62	68	74	80	85	90	93	94	92	88
4770	83	77	69	59	48	36	26	15	6	-1
4780	-8	-14	-20	-24	-29	-33	-35	-36	-34	-29
4790	-24	-20	-17	-16	-15	-14	-15	-16	-17	-20
4800	-26	-29	-31	-32	-30	-29	-27	-26	-24	-22

TO BE CONTINUED

CONTINUED(S-2111 E03N)

NO.	(1)	(2)	(3)	(4)	(5)	(6)	(7)	(8)	(9)	(10)
4810	-16	-13	-11	-9	-7	-4	0	3	5	5
4820	4	2	0	-1	-3	-7	-23	-12	-13	-13
4830	-14	-17	-20	-22	-23	-23	-23	-22	-20	-19
4840	-18	-16	-11	-7	-1	5	11	18	23	26
4850	30	31	28	24	24	16	12	10	6	2
4860	1	1	6	10	14	19	23	25	26	28
4870	30	30	28	26	26	26	25	25	25	25
4880	27	25	23	20	16	12	8	4	0	-3
4890	-6	-9	-13	-14	-13	-13	-16	-16	-14	-13
4900	-11	-10	-6	-2	1	4	6	6	5	3
4910	1	0	0	0	1	3	6	12	18	23
4920	27	30	31	31	29	25	23	19	14	9
4930	6	2	0	-2	-6	-8	-11	-13	-17	-19
4940	-22	-24	-26	-25	-23	-23	-22	-21	-20	-18
4950	-15	-11	-8	-5	-1	7	14	22	31	40
4960	50	59	66	70	71	70	68	64	56	48
4970	40	31	22	15	9	5	2	0	-4	-8
4980	-11	-13	-14	-17	-18	-19	-22	-24	-25	-29
4990	-34	-39	-43	-41	-47	-47	-48	-47	-41	-33
5000	-25	-16	-7	-1	6	13	19	24	27	30
5010	31	34	37	41	43	46	51	56	57	57
5020	56	55	52	49	43	38	33	27	23	17
5030	11	4	0	-3	-7	-10	-12	-13	-14	-14
5040	-13	-14	-15	-17	-19	-21	-24	-27	-30	-35
5050	-37	-41	-43	-46	-49	-52	-54	-55	-58	-61
5060	-63	-66	-70	-75	-80	-84	-86	-87	-88	-87
5070	-84	-79	-71	-59	-46	-31	-16	-2	8	19
5080	28	39	47	54	61	67	74	80	85	89
5090	92	91	88	83	74	64	54	42	35	28
5100	28	24	20	16	13	11	9	9	6	4
5110	2	0	-3	-4	-5	-7	-6	-7	-7	-6
5120	-6	-4	-1	3	10	16	22	28	33	37
5130	40	40	39	38	35	31	27	25	20	14
5140	8	3	0	-3	-7	-11	-15	-20	-22	-23
5150	-23	-22	-20	-16	-13	-12	-10	-9	-10	-13
5160	-13	-11	-12	-12	-9	-9	-7	-7	-7	-7
5170	-8	-9	-9	-8	-10	-11	-12	-12	-9	-7
5180	-5	-1	4	10	17	22	28	32	35	39
5190	41	40	40	36	33	29	25	21	14	8
5200	3	-1	-4	-6	-10	-12	-13	-14	-14	-13
5210	-13	-12	-11	-7	-5	-3	-2	-2	-1	-1
5220	-13	-16	-19	-23	-27	-31	-37	-43	-48	-51
5230	-13	-16	-19	-23	-27	-31	-37	-43	-48	-51
5240	-52	-54	-54	-54	-54	-52	-49	-49	-50	-51
5250	-49	-48	-47	-47	-44	-42	-39	-34	-31	-26
5260	-18	-12	-8	-3	3	9	14	20	27	33
5270	40	46	50	52	53	51	47	40	33	26
5280	19	12	5	0	-7	-11	-14	-17	-21	-24
5290	-27	-30	-31	-30	-29	-26	-22	-19	-16	-12
5300	-9	-8	-7	-5	-4	-4	-5	-6	-8	-11
5310	-12	-13	-14	-14	-11	-9	-7	-3	0	6
5320	14	21	29	39	49	57	62	65	66	64
5330	59	54	48	41	34	29	26	21	18	12
5340	5	-2	-6	-11	-14	-16	-17	-19	-18	-17

TO BE CONTINUED

CONTINUED(S-2111 E03N)

NO.	(1)	(2)	(3)	(4)	(5)	(6)	(7)	(8)	(9)	(10)
5350	-15	-13	-10	-7	-5	-2	2	8	15	21
5360	27	32	36	40	44	48	47	43	39	33
5370	28	23	21	17	9	2	-4	-10	-15	-23
5380	-31	-38	-45	-51	-56	-62	-68	-74	-77	-68
5390	-78	-79	-79	-79	-76	-73	-68	-62	-55	-47
5400	-39	-32	-27	-22	-17	-13	-10	-9	-6	-3
5410	-2	0	1	2	2	1	1	2	2	3
5420	6	10	11	12	14	15	16	18	21	22
5430	25	24	25	26	26	27	26	25	23	17
5440	10	5	-2	-2	-6	-7	-8	-11	-12	-13
5450	-13	-15	-18	-22	-25	-30	-35	-39	-41	-43
5460	-46	-51	-55	-58	-59	-60	-61	-60	-55	-51
5470	-46	-40	-32	-24	-16	-8	1	13	24	34
5480	46	55	61	65	68	73	76	77	78	78
5490	78	78	77	74	71	68	66	63	62	58
5500	55	48	45	38	35	32	30	26	23	22
5510	22	23	23	22	21	21	21	22	22	21
5520	19	16	16	16	16	15	14	13	16	18
5530	18	19	18	16	16	14	11	7	2	-1
5540	-3	-4	-5	-6	-6	-6	-6	-8	-11	-14
5550	-18	-23	-26	-27	-27	-27	-29	-29	-30	-32
5560	-36	-40	-42	-42	-43	-43	-43	-43	-43	-39
5570	-35	-33	-31	-29	-27	-24	-23	-25	-26	-24
5580	-23	-21	-21	-19	-16	-13	-10	-6	-2	-1
5590	3	9	12	13	14	15	15	16	17	15
5600	12	11	10	7	5	4	4	5	4	2
5610	1	0	0	-2	-2	-2	-2	-1	-1	0
5620	0	0	2	7	11	13	14	17	19	20
5630	21	20	19	19	20	21	20	17	13	10
5640	7	5	3	0	-3	-7	-11	-17	-23	-30
5650	-36	-42	-49	-54	-60	-66	-71	-73	-74	-74
5660	-74	-74	-73	-68	-64	-59	-55	-48	-43	-37
5670	-31	-26	-19	-12	-3	6	13	19	25	30
5680	34	39	41	46	47	48	47	45	42	39
5690	34	29	25	20	15	11	6	4	3	3
5700	2	2	3	5	8	11	14	18	23	28
5710	31	32	32	32	31	27	23	16	10	6
5720	2	-1	-4	-6	-10	-14	-17	-18	-19	-19
5730	-23	-26	-30	-32	-33	-35	-39	-41	-42	-43
5740	-43	-42	-41	-39	-39	-43	-48	-51	-55	-60
5750	-17	-2	3	8	12	14	16	17	17	19
5760	22	23	24	26	26	28	27	25	23	20
5770	14	7	2	-1	-6	-13	-20	-27	-35	-42
5780	-47	-52	-56	-58	-59	-60	-61	-60	-59	-57
5790	-33	-30	-28	-26	-24	-21	-19	-14	-8	-2
5800	-22	-16	-9	-3	0	4	9	14	19	24
5810	29	33	33	38	41	44	47	48	50	51
5820	51	51	51	52	53	52	52	51	47	42
5830	38	35	31	26	21	14	10	6	2	-1
5840	-6	-10	-12	-12	-12	-12	-12	-11	-10	-8

END

RECORD = S-2111 COMPONENT = DOWN STATION = SHINAGAWA-S
 DATE AND TIME = 1987-12-17-11-08 TOTAL NUMBER OF DATA = 5850
 SAMPLING INTERVAL = 0.010 (SEC) SCAL = 0.10000
 SIGNAL = GR. ACC.
 CONNECTION POINT IN DATA NUMBER = 3042, 5850.

CONTINUED(S-2111 DOWN)

NO.	(1)	(2)	(3)	(4)	(5)	(6)	(7)	(8)	(9)	(10)
0	-28	-26	-25	-24	-23	-22	-20	-19	-17	-15
10	-14	-12	-11	0	8	5	8	12	17	17
20	-1	-1	0	1	5	8	12	17	17	17
30	22	28	31	35	36	35	30	24	15	15
40	3	-8	-21	-33	-44	-54	-60	-66	-67	-67
50	-67	-66	-62	-60	-57	-55	-49	-40	-25	-44
60	-7	9	24	33	37	39	36	32	27	23
70	31	24	30	37	45	49	50	43	26	0
80	-37	-72	-96	-110	-116	-115	-109	-95	-80	-67
90	-36	-48	-44	-42	-42	-39	-28	-10	17	55
100	95	125	143	150	147	135	103	64	27	0
110	-15	-22	-22	-22	-24	-27	-32	-37	-40	-37
120	-43	-47	-51	-54	-54	-48	-31	13	0	10
130	15	17	16	11	5	3	8	21	37	54
140	67	72	67	50	14	-35	-61	-107	-113	-102
150	-72	-36	-9	8	16	17	16	14	19	28
160	36	41	43	36	17	-8	-39	-69	-94	-108
170	-114	-111	-98	-73	-43	-19	-2	6	13	19
180	30	46	65	83	92	91	83	72	58	55
190	51	46	42	35	27	17	4	-5	-11	-12
200	-9	-2	6	18	20	29	37	44	50	55
210	59	58	54	50	44	37	28	15	-6	-33
220	-62	-66	-69	-105	-96	-81	-62	-42	-24	-16
230	-12	-11	-10	-6	1	5	7	4	-1	-12
240	-28	-34	-34	-23	-6	17	36	44	48	46
250	41	36	32	32	35	36	38	36	33	25
260	13	3	-1	-4	-6	-10	-14	-21	-28	-34
270	-37	-35	-32	-29	-29	-29	-33	-39	-43	-41
280	-33	-20	-7	4	9	10	10	8	4	1
290	4	10	17	21	23	21	15	0	-9	-13
300	-14	-11	-4	0	4	5	5	5	0	0
310	-9	-18	-26	-35	-39	-38	-27	-10	11	26
320	33	38	38	38	36	32	31	24	14	2
330	-10	-27	-27	-28	-26	-25	-22	-10	14	14
340	29	35	34	29	16	15	16	21	30	38
350	44	45	45	43	40	34	25	14	2	-10
360	-21	-52	-42	-48	-50	-45	-35	-15	-1	11
370	21	30	33	31	22	3	-23	-49	-67	-74
380	-76	-71	-60	-45	-32	-25	-19	-15	-16	-16
390	-17	-18	-17	-9	10	30	42	45	42	28
400	4	-17	-34	-41	-38	-23	-13	-7	-5	-6
410	-9	-15	-20	-19	-20	-14	-14	-4	4	16
420	31	41	46	48	41	28	11	4	1	2
430	7	14	20	26	31	35	37	36	35	34
440	29	21	12	1	-10	-22	-34	-42	-47	-49
450	-46	-37	-19	3	30	52	61	60	52	29
460	-40	-23	-39	-45	-43	-36	-29	-21	-16	-14
470	-15	-15	-22	-33	-39	-40	-32	-17	-3	19
480	28	29	24	16	2	-8	-11	-12	-10	-17

TO BE CONTINUED

TO BE CONTINUED

CONTINUED (S-2111 DOWN)

CONTINUED (S-2111 DOWN)

NO.	(1)	(2)	(3)	(4)	(5)	(6)	(7)	(8)	(9)	(10)
1030	115	62	11	-27	-53	-66	-74	-80	-84	-86
1040	-89	-90	-85	-74	-57	-35	-15	-6	-2	-3
1050	-12	-24	-36	-49	-37	-55	-51	-43	-27	-33
1060	-8	6	19	30	41	47	53	56	59	62
1070	65	66	66	65	66	71	78	88	96	99
1080	98	92	83	71	56	36	12	-8	-25	-38
1090	-49	-57	-64	-74	-84	-93	-99	-104	-108	-112
1100	-115	-115	-110	-97	-75	-45	-18	0	12	17
1110	18	15	10	8	7	7	7	7	7	5
1120	5	0	-1	6	16	27	43	57	73	90
1130	106	126	141	154	161	163	159	151	135	107
1140	73	28	-17	-54	-75	-81	-83	-79	-67	-48
1150	-25	-3	13	26	32	28	16	-2	-23	-43
1160	-58	-72	-82	-92	-102	-111	-112	-106	-89	-57
1170	-14	31	66	85	91	85	70	50	35	28
1180	29	37	43	48	52	55	57	58	58	58
1190	59	57	56	55	54	53	52	50	49	49
1200	49	43	30	9	-19	-55	-96	-132	-158	-167
1210	-168	-160	138	-110	-80	-50	-24	-4	11	29
1220	49	66	85	100	107	104	90	66	31	-5
1230	-28	-39	-40	-35	-26	-20	-17	-15	-16	-15
1240	-11	0	23	52	77	94	101	101	98	90
1250	80	70	62	54	45	34	21	9	2	-1
1260	-2	0	4	10	17	25	33	38	39	36
1270	27	13	2	-1	0	6	15	22	25	19
1280	4	-21	-52	-83	-112	-135	-149	-159	-161	-158
1290	-146	-120	-80	-32	16	50	75	94	106	112
1300	112	106	95	75	48	18	-7	-27	-42	-52
1310	-54	-55	-53	-50	-46	-42	-39	-35	-31	-27
1320	-4	-19	-15	-13	-12	-13	-16	-19	-20	-15
1330	-7	4	17	27	30	28	21	7	-9	-28
1340	-45	-60	-75	-91	-104	-112	-114	-112	-104	-93
1350	148	127	101	77	51	26	9	0	2	-5
1360	-1	3	8	10	15	19	21	24	28	31
1370	-11	3	8	10	15	19	21	24	28	31
1380	35	39	42	44	44	44	41	36	31	22
1390	14	15	18	23	29	38	46	57	71	84
1400	94	97	91	74	43	12	-11	-9	-41	-47
1410	-51	-54	-56	-56	-51	-43	-33	-21	-14	-14
1420	-19	-31	-52	-74	-89	-100	-107	-111	-111	-107
1430	-100	-93	-88	-85	-83	-81	-80	-82	-83	-84
1440	-84	-84	-85	-85	-86	-87	-86	-82	-77	-79
1450	-22	26	60	91	124	141	148	148	141	128
1460	110	95	83	74	68	65	61	55	47	38
1470	28	19	12	9	8	8	8	8	7	5
1480	3	4	6	12	23	38	55	73	89	99
1490	102	100	89	68	41	11	-13	-36	-54	-65
1500	-70	-71	-68	-63	-56	-47	-40	-33	-27	-16
1510	-5	0	1	-1	-16	-45	-79	-102	-112	-116
1520	-112	-100	-81	-63	-46	-33	-19	-12	-5	0
1530	-1	-5	-7	-11	-13	-15	-16	-17	-17	-22
1540	-28	-33	-41	-55	-72	-95	-114	-127	-130	-121
1550	-98	-62	-21	21	60	88	104	116	124	129
1560	132	132	129	122	111	95	73	49	28	11

TO BE CONTINUED

TO BE CONTINUED

CONTINUED (S-2111 DOWN)

CONTINUED (S-2111 DOWN)

NO.	(1)	(2)	(3)	(4)	(5)	(6)	(7)	(8)	(9)	(10)
2110	49	60	66	66	62	56	43	27	10	-3
2120	-13	-23	-31	-38	-45	-52	-59	-64	-67	-65
2130	-60	-51	-38	-21	-3	9	18	21	21	17
2140	11	4	-8	-23	-3	-39	-41	-40	-36	-40
2150	-21	-12	-2	8	22	38	53	64	72	79
2160	82	79	72	62	49	35	21	9	1	-5
2170	-10	-11	-12	-10	-6	-4	-4	-2	-2	-4
2180	-13	-21	-26	-31	-36	-38	-39	-34	-29	-34
2190	-18	-13	-8	-5	-3	0	2	12	20	20
2200	29	36	42	44	44	44	44	42	36	29
2210	20	9	15	-2	-22	-28	-29	-27	-22	-15
2220	-6	3	15	27	39	48	54	60	61	59
2230	54	47	39	29	17	8	0	-3	-4	-6
2240	-7	-7	-6	-5	-5	-7	-9	-11	-13	-15
2250	-14	-12	-11	-7	-4	4	4	3	4	4
2260	7	9	9	9	9	13	16	18	16	-8
2270	-9	-6	-3	2	8	16	16	13	13	13
2280	12	15	21	28	34	38	43	46	48	52
2290	55	57	59	58	59	60	57	53	48	38
2300	25	-6	-16	-25	-33	-39	-39	-43	-45	-44
2310	-44	-42	-41	-40	-41	-44	-44	-48	-53	-58
2320	-61	-59	-55	-49	-42	-35	-31	-28	-26	-24
2330	-23	-22	-18	-15	-13	-12	-12	-12	-8	-7
2340	-10	-9	-7	-6	-6	-6	-5	-4	-2	-1
2350	0	0	0	0	2	3	3	3	2	0
2360	-2	-6	-10	-12	-12	-13	-14	-11	-7	-4
2370	0	6	11	17	25	30	32	34	36	38
2380	39	37	33	27	21	14	18	20	23	26
2390	-6	-2	2	7	11	14	18	20	23	26
2400	28	31	33	34	35	30	22	12	1	-7
2410	-13	-15	-16	-15	-13	-12	-12	-12	-15	-16
2420	-20	-20	-19	-17	-17	-20	-22	-25	-27	-31
2430	-34	-37	-36	-32	-27	-21	-14	-8	-1	3
2440	6	8	7	7	7	8	7	7	7	7
2450	5	3	1	0	-2	-2	-2	-2	-2	-5
2460	-10	-16	-22	-27	-30	-32	-32	-32	-29	-26
2470	-22	-19	-17	-16	-17	-21	-22	-22	-21	-19
2480	-15	-9	-4	-2	0	2	4	5	4	1
2490	0	0	-1	-4	-6	-10	-12	-10	-9	-10
2500	-10	-12	-12	-14	-14	-14	-14	-12	-11	-10
2510	-4	0	7	13	24	35	38	41	43	42
2520	40	37	33	28	23	18	10	4	-1	-10
2530	-16	-21	-23	-24	-24	-24	-23	-21	-17	-11
2540	-3	6	18	27	34	37	37	33	27	17
2550	8	0	-5	-10	-13	-14	-12	-8	-3	2
2560	8	13	19	22	21	20	15	9	5	1
2570	-1	-1	-2	-4	-6	-7	-8	-11	-12	-14
2580	-15	-15	-15	-15	-12	-9	-4	-1	2	8
2590	11	15	18	19	20	19	19	17	14	10
2600	7	4	-1	-5	-9	-11	-12	-15	-19	-22
2610	-24	-26	-25	-24	-22	-18	-13	-7	0	6
2620	11	16	21	27	34	39	42	45	45	43
2630	39	37	36	34	33	36	39	43	47	48
2640	46	45	42	37	31	22	15	8	0	-6

TO BE CONTINUED

TO BE CONTINUED

CONTINUED(S-2111 DOWN)

CONTINUED(S-2111 DOWN)

NO.	(1)	(2)	(3)	(4)	(5)	(6)	(7)	(8)	(9)	(10)
3190	-13	-18	-19	-21	-25	-28	-27	-25	-22	-18
3200	-10	-8	-3	0	4	9	13	17	20	23
3210	26	27	27	27	28	26	19	15	10	10
3220	5	0	-5	-8	-11	-16	-20	-24	-26	-27
3230	-30	-30	-28	-26	-23	-22	-21	-19	-17	-14
3240	-10	-5	1	11	14	14	16	19	20	20
3250	23	26	29	34	39	44	46	48	48	46
3260	38	29	21	11	2	-5	-15	-24	-31	-38
3270	-44	-48	-49	-48	-45	-42	-37	-31	-24	-19
3280	-13	-8	-3	0	1	0	0	0	0	0
3290	-1	-3	-3	-3	-2	0	1	1	4	9
3300	13	16	20	22	22	23	24	23	21	21
3310	22	22	19	17	17	17	14	12	9	8
3320	6	2	1	1	1	0	-3	0	-3	-5
3330	-8	-9	-8	-6	-5	-4	-1	4	4	13
3340	17	19	20	21	18	14	10	9	6	4
3350	2	3	4	2	2	4	3	1	3	7
3360	11	15	17	19	21	20	17	13	11	10
3370	8	6	5	2	0	0	-3	-5	-6	-7
3380	-8	-8	-7	-6	-5	-5	-3	0	2	2
3390	6	6	4	6	7	8	11	14	18	19
3400	22	23	23	20	18	16	13	9	4	0
3410	-5	-5	-9	-12	-15	-18	-18	-16	-12	-4
3420	3	10	16	20	23	22	19	16	11	2
3430	-5	-13	-19	-23	-27	-32	-35	-37	-39	-42
3440	-43	-43	-41	-37	-34	-32	-28	-23	-18	-14
3450	-11	-7	-4	-3	-1	0	2	3	13	16
3460	20	24	27	30	29	27	25	23	22	22
3470	18	13	8	4	-1	-6	-10	-12	-11	-12
3480	-10	-6	-5	-5	-2	0	1	-2	-3	-4
3490	-6	-8	-11	-15	-20	-23	-24	-25	-26	-30
3500	-32	-33	-32	-29	-27	-25	-23	-19	-14	-10
3510	-8	-8	-8	-8	-8	-9	-12	-15	-16	-17
3520	-20	-21	-22	-22	-21	-20	-18	-16	-14	-11
3530	-7	-4	-1	1	9	15	18	22	28	33
3540	39	41	43	41	39	36	34	30	27	27
3550	27	24	26	29	29	33	36	36	34	34
3560	33	32	30	26	21	16	11	7	4	2
3570	0	-3	-4	-4	-10	-14	-18	-23	-29	-35
3580	-39	-43	-43	-43	-41	-39	-37	-34	-29	-23
3590	-16	-8	-2	2	8	14	17	18	17	14
3600	14	14	9	5	2	0	0	0	0	0
3610	-4	-3	-4	-3	-4	-5	-6	-6	-6	-6
3620	-7	-6	-6	-6	-3	-1	0	-1	-4	-5
3630	-6	-6	-6	-6	-4	1	3	6	11	12
3640	15	20	26	30	35	37	37	35	30	24
3650	20	16	13	9	4	-5	-4	0	-1	-5
3660	-2	-2	-3	-3	-4	-5	-7	-5	-3	0
3670	-6	-9	-11	-10	-9	-8	-7	-5	-3	-6
3680	1	2	3	1	1	1	0	-1	-3	-6
3690	-9	-14	-17	-20	-24	-25	-25	-24	-22	-21
3700	-19	-17	-14	-10	-6	-2	0	0	0	0
3710	-4	-5	-9	-14	-15	-16	-20	-22	-22	-25
3720	-26	-27	-27	-26	-22	-18	-15	-8	0	6
3730	8	11	14	13	10	7	5	3	2	0
3740	4	7	9	9	11	12	12	12	11	9
3750	5	2	-1	-4	-5	-5	-5	-7	-10	-12
3760	-13	-15	-17	-17	-16	-15	-14	-12	-11	-10
3770	-6	-3	0	1	1	1	1	1	1	0
3780	0	-1	-2	-3	-2	1	1	1	1	3
3790	16	17	16	13	13	14	14	14	13	11
3800	16	17	18	13	12	14	14	14	13	11
3810	11	11	11	10	10	10	10	10	11	11
3820	-2	-2	-3	-3	-2	2	2	2	0	-1
3830	8	8	8	7	7	6	5	3	2	0
3840	-5	-8	-8	-11	-12	-11	-11	-11	-10	-8
3850	-12	-16	-18	-20	-20	-19	-17	-17	-15	-13
3860	-14	-14	-13	-11	-12	-11	-12	-9	-6	-5
3870	-5	-3	-1	1	5	8	12	14	18	19
3880	22	26	27	29	29	26	26	23	19	14
3890	6	-1	-5	-9	-16	-20	-23	-23	-23	-24
3900	-25	-22	-17	-13	-12	-10	-6	-4	0	4
3910	6	9	11	14	18	21	24	27	27	27
3920	27	27	26	25	23	23	24	23	21	21
3930	22	23	25	26	25	24	21	17	13	9
3940	5	3	1	0	-1	-2	0	2	2	8
3950	11	15	17	22	23	24	24	22	19	17
3960	16	14	9	6	3	3	3	0	-1	-3
3970	-3	-1	0	1	3	5	5	3	3	3
3980	2	0	-2	-4	-6	-10	-14	-16	-16	-16
3990	-17	-16	-14	-14	-15	-16	-15	-13	-12	-12
4000	-10	-8	-7	-5	-4	-3	-3	-2	-2	-1
4010	-1	-1	-1	-1	-1	-1	-1	-1	-1	-1
4020	-19	-19	-18	-18	-15	-8	-3	-5	-9	-18
4030	7	8	9	9	10	12	15	18	19	21
4040	22	26	29	31	31	29	28	27	27	28
4050	29	29	29	29	30	30	28	27	25	25
4060	21	20	17	14	11	8	4	0	-1	-4
4070	-7	-9	-10	-11	-13	-15	-15	-14	-13	-12
4080	-10	-10	-8	-8	-7	-5	-3	-3	0	0
4090	1	4	7	9	10	12	15	16	16	16
4100	15	15	15	14	13	11	9	6	3	3
4110	0	-5	-9	-14	-18	-21	-25	-29	-30	-28
4120	-30	-30	-30	-27	-27	-27	-27	-24	-21	-21
4130	-21	-19	-16	-14	-11	-10	-8	-5	-3	-2
4140	-1	-1	-2	-2	-2	-2	-2	-2	-4	-6
4150	-6	-5	-5	-5	-3	-1	0	1	3	2
4160	0	0	-2	-2	-3	-6	-9	-9	-11	-16
4170	-15	-12	-11	-12	-11	-12	-12	-10	-7	-4
4180	-5	-3	-2	-1	0	2	4	6	9	11
4190	11	9	7	7	11	14	12	11	11	11
4200	13	16	18	21	21	21	19	18	17	13
4210	10	5	2	-1	-4	-8	-12	-11	-13	-14
4220	-17	-17	-13	-11	-11	-9	-5	-5	-5	-4
4230	-4	-3	-3	-3	-3	-3	-2	-1	0	1
4240	3	7	11	12	11	11	14	17	18	19
4250	19	16	12	7	1	-3	-6	-8	-11	-11
4260	-9	-8	-6	-3	0	2	7	11	13	15

TO BE CONTINUED

TO BE CONTINUED

CONTINUED (S-2111 DOWN)										CONTINUED (S-2111 DOWN)											
NO.	(1)	(2)	(3)	(4)	(5)	(6)	(7)	(8)	(9)	(10)	NO.	(1)	(2)	(3)	(4)	(5)	(6)	(7)	(8)	(9)	(10)
4270	17	18	18	16	14	9	6	3	-1	-5	4810	0	1	2	4	6	5	5	-2	6	5
4280	-9	-14	-16	-18	-20	-17	-15	-13	-7	-10	4820	0	3	3	3	6	0	-1	-6	-3	-5
4290	-6	-4	-2	0	2	4	5	7	7	7	4830	-5	-8	-8	-9	-13	-15	-15	-13	-16	-16
4300	6	5	2	0	-2	-4	-5	-4	-3	-3	4840	-15	-1	-1	-14	-11	-6	-6	-4	-1	-1
4310	-6	-6	-5	-5	-5	-5	-5	-4	-3	-4	4850	0	1	1	1	2	3	4	5	4	4
4320	-2	0	0	1	1	1	0	0	0	0	4860	5	4	7	9	10	13	14	16	19	19
4330	1	2	0	4	5	5	5	1	-1	-3	4870	19	19	19	19	19	18	17	14	11	8
4340	-5	-8	-10	-10	-11	-12	-13	-17	-18	-18	4880	4	2	1	1	1	0	-1	-4	-5	-7
4350	-18	-18	-14	-14	-9	-6	-5	-4	-1	-4	4890	-8	-9	-10	-10	-13	-15	-16	-16	-15	-15
4360	1	4	4	6	4	4	6	4	4	8	4900	-15	-14	-12	-10	-9	-8	-8	-7	-7	-7
4370	12	12	13	14	15	18	19	19	19	18	4910	-6	-6	-4	-4	-5	-6	-6	-4	-3	-3
4380	17	16	15	11	10	7	4	1	1	-3	4920	0	1	0	0	0	0	0	-1	-4	-5
4390	-4	-5	-5	-5	-4	-2	0	2	4	6	4930	-6	-8	-10	-10	-10	-10	-10	-9	-9	-7
4400	9	13	16	19	23	25	26	27	27	26	4940	-6	-5	-2	-1	0	3	5	5	4	5
4410	24	21	18	14	10	6	1	-2	-5	-6	4950	7	7	8	8	8	9	11	14	15	14
4420	-8	-10	-10	-9	-9	-10	-9	-8	-9	-10	4960	14	16	18	19	19	20	21	20	19	17
4430	-12	-15	-16	-16	-16	-21	-21	-19	-17	-17	4970	14	12	10	7	6	4	5	5	4	5
4440	-16	-17	-17	-15	-13	-11	-10	-10	-10	-6	4980	3	4	5	5	5	5	7	7	7	8
4450	-5	-5	-5	-4	-3	-2	-2	-1	-1	-1	4990	6	5	6	6	6	6	7	7	8	8
4460	-1	0	0	0	0	-1	-5	-6	-4	-4	5000	4	3	4	3	4	4	2	0	0	0
4470	-6	-7	-6	-5	-5	-5	-5	-4	-3	-3	5010	0	0	0	-1	-2	-2	-3	-2	-1	-1
4480	-2	0	0	2	5	7	8	8	8	7	5020	-2	0	0	-1	-1	2	0	0	-1	-2
4490	7	7	9	10	12	14	15	16	16	16	5030	-3	-4	-6	-9	-13	-14	-15	-16	-17	-16
4500	17	17	16	16	15	14	14	12	10	6	5040	-13	-11	-10	-10	-10	-9	-8	-8	-8	-10
4510	4	3	0	-1	-4	-5	-5	-5	-6	-6	5050	-11	-12	-11	-9	-8	-7	-7	-7	-5	-3
4520	-4	-4	-5	-5	-5	-5	-5	-5	-5	-5	5060	0	1	2	3	3	3	4	5	5	4
4530	-8	-10	-10	-8	-8	-7	-5	-1	6	10	5070	5	6	5	5	5	7	10	11	12	14
4540	12	15	18	18	16	14	12	13	11	8	5080	15	17	17	17	17	17	17	17	17	17
4550	4	0	-3	-3	-3	-4	-5	-5	-5	-5	5090	17	17	16	17	16	13	13	11	11	9
4560	-4	-3	-3	-3	-3	-4	-4	-5	-5	-5	5100	8	7	7	7	6	4	4	3	3	3
4570	-5	-5	-5	-5	-5	-6	-6	-6	-6	-6	5110	2	1	-1	-4	-6	-6	-6	-7	-7	-6
4580	-8	-10	-10	-10	-9	-7	-4	10	11	12	5120	-7	-8	-8	-8	-9	-12	-14	-15	-17	-20
4590	3	3	5	7	8	9	9	9	10	11	5130	-21	-22	-24	-25	-24	-23	-23	-21	-19	-19
4600	12	12	10	9	8	8	7	6	7	3	5140	-16	-13	-13	-13	-13	-11	-9	-8	-6	-4
4610	3	2	1	0	-1	-2	-1	-1	0	0	5150	-3	0	1	2	4	6	7	8	11	13
4620	-1	-2	-3	-4	-5	-5	-5	-5	-5	-5	5160	12	13	14	13	15	16	16	16	15	14
4630	-3	-1	0	0	0	0	2	4	6	8	5170	14	13	13	11	9	9	11	11	11	11
4640	8	9	9	9	7	5	1	0	-2	-3	5180	11	12	12	13	12	12	13	13	12	10
4650	-3	-4	-5	-5	-5	-4	-3	-4	-5	-5	5190	8	7	5	3	1	2	1	-1	-3	-4
4660	-7	-3	0	0	0	3	5	10	13	15	5200	-5	-4	-4	-6	-8	-8	-10	-12	-14	-17
4670	16	18	19	19	16	14	11	11	12	10	5210	-19	-20	-20	-22	-23	-23	-23	-22	-20	-21
4680	8	8	9	9	9	8	6	6	6	7	5220	-18	-18	-16	-11	-7	-4	-1	8	11	11
4690	8	8	8	7	6	6	4	2	0	-2	5230	12	14	18	21	24	26	29	31	33	35
4700	-3	-5	-6	-6	-6	-8	-8	-9	-9	-10	5240	36	36	36	37	38	38	37	38	38	35
4710	-9	-8	-8	-8	-8	-10	-13	-17	-17	-17	5250	32	32	30	22	19	17	17	12	8	8
4720	-18	-16	-16	-15	-14	-11	-8	-5	-4	-3	5260	7	7	7	7	6	4	0	-2	-2	-2
4730	-3	-2	-2	-2	-2	-2	-2	-2	-2	-2	5270	-2	-4	-4	-7	-7	-7	-7	-7	-8	-8
4740	-2	-2	-4	-5	-6	-6	-8	-10	-10	-10	5280	-2	-6	-6	-9	-9	-12	-15	-18	-20	-21
4750	-11	-12	-15	-16	-14	-13	-11	-11	-8	-8	5290	-22	-21	-19	-19	-19	-18	-17	-14	-11	-10
4760	-8	-8	-8	-7	-7	-7	-7	-7	-7	-6	5300	-9	-8	-7	-7	-7	-7	-7	-7	-7	-7
4770	-6	-6	-5	-5	-5	-5	-5	-5	-5	-5	5310	1	1	1	1	1	0	-2	-1	-2	-2
4780	0	2	2	3	3	3	3	2	2	1	5320	-2	-4	-5	-6	-6	-6	-7	-6	-6	-6
4790	-2	-4	-7	-9	-10	-10	-10	-10	-10	-10	5330	-5	-5	-5	-5	-5	-5	-5	-5	-7	-7
4800	-10	-10	-10	-8	-7	-5	-5	-3	-1	-1	5340	-7	-7	-7	-7	-7	-6	-5	-4	-8	-10

TO BE CONTINUED

TO BE CONTINUED

CONTINUED (S-2111 DOWN)

NO.	(1)	(2)	(3)	(4)	(5)	(6)	(7)	(8)	(9)	(10)
5350	-10	-10	-9	-7	-5	-5	-4	-2	0	1
5360	1	5	6	8	7	7	7	6	6	6
5370	6	7	7	5	6	6	9	8	10	11
5380	10	9	9	8	7	7	9	9	9	8
5390	8	8	7	6	5	4	4	1	1	1
5400	1	0	0	-1	-3	-4	-2	0	-1	-3
5410	-4	-5	-5	-5	-5	-5	-4	-6	-7	-7
5420	-7	-7	-7	-6	-5	-4	-3	-2	-1	-4
5430	-5	-4	-1	-4	-5	-6	-6	-5	-5	-5
5440	-5	-5	-5	-5	-5	-6	-7	-6	-5	-5
5450	-7	-7	-8	-8	-8	-8	-7	-5	-4	-3
5460	-3	-2	-2	0	0	0	-1	0	2	3
5470	4	4	3	1	1	1	1	1	1	1
5480	1	0	-1	0	3	5	6	7	7	8
5490	7	7	8	8	8	7	6	4	3	1
5500	0	0	-1	-2	-3	-3	-1	-1	0	0
5510	1	1	1	0	0	0	-2	-3	-3	-2
5520	-1	-1	-1	-2	-1	-2	-1	-1	1	2
5530	1	1	1	1	1	0	-1	-2	-4	-5
5540	-5	-6	-7	-8	-10	-11	-12	-12	-11	-12
5550	-17	-16	-18	-20	-19	-18	-18	-19	-18	-18
5560	-17	-16	-16	-14	-12	-10	-8	-7	-7	-5
5570	-5	-3	-2	-5	-5	-6	-6	-9	-14	-16
5580	-20	-22	-27	-31	-31	-31	-32	-33	-32	-30
5590	-30	-29	-26	-24	-22	-22	-22	-22	-21	-21
5600	-21	-21	-20	-21	-22	-20	-20	-18	-8	-14
5610	-11	-8	-5	-1	1	2	3	5	6	10
5620	10	9	9	9	7	5	3	1	1	3
5630	5	1	1	2	2	2	1	0	0	1
5640	3	3	2	1	1	1	2	3	3	3
5650	3	2	2	3	5	7	7	7	6	4
5660	6	4	4	3	3	5	7	7	8	10
5670	13	14	14	14	13	16	18	18	17	17
5680	17	18	15	12	12	12	10	7	6	2
5690	2	2	3	3	2	1	1	1	0	0
5700	0	-3	-5	-5	-5	-5	-5	-6	-5	-5
5710	-5	-4	-3	-3	0	1	1	3	4	4
5720	3	3	3	3	5	5	5	6	7	8
5730	10	11	11	12	12	12	10	9	7	5
5740	3	0	-1	-3	-5	-6	-7	-10	-11	-12
5750	-13	-15	-14	-13	-15	-15	-14	-13	-13	-12
5760	-10	-9	-7	-8	-5	-5	-6	-7	-7	-7
5770	-6	-7	-8	-8	-8	-9	-10	-11	-13	-13
5780	-11	-9	-8	-8	-8	-7	-7	-6	-6	-5
5790	-4	-3	-1	0	-1	-1	0	2	3	4
5800	5	8	9	8	7	7	7	7	8	8
5810	9	8	8	9	11	11	13	13	15	17
5820	17	14	12	12	11	11	11	12	11	11
5830	11	12	12	12	11	11	10	9	8	8
5840	7	4	2	2	0	-2	-3	-3	-4	-5

END

RECORD = S-2112 COMPONENT = N33E STATION = KEIHN-JI-S
 DATE AND TIME = 1987-12-17-11-08 TOTAL NUMBER OF DATA = 6000
 SAMPLING INTERVAL = 0.010 (SEC) SCAL = 0.10000
 SIGNAL = GR. ACC.
 CONNECTION POINT IN DATA NUMBER = 3006, 6000.

NO.	(1)	(2)	(3)	(4)	(5)	(6)	(7)	(8)	(9)	(10)
0	-15	-13	-12	-15	-14	-14	-14	-14	-13	-13
10	-13	-12	-12	-12	-12	-11	-11	-11	-11	-11
20	-11	-10	-10	-10	-10	-9	-9	-9	-8	-8
30	-8	-7	-7	-7	-8	-8	-8	-9	-9	-9
40	-9	-9	-9	-10	-10	-11	-13	-13	-13	-13
50	-11	-11	-11	-11	-11	-11	-11	-11	-11	-11
60	-13	-13	-13	-13	-13	-13	-13	-13	-13	-13
70	-13	-13	-13	-13	-13	-13	-13	-13	-13	-13
80	-14	-15	-14	-13	-13	-14	-15	-15	-15	-15
90	-14	-13	-13	-14	-13	-13	-13	-13	-13	-13
100	-13	-13	-12	-11	-10	-8	-7	-7	-9	-10
110	-11	-13	-15	-19	-19	-20	-20	-20	-20	-20
120	-19	-18	-16	-14	-12	-11	-11	-11	-11	-11
130	-13	-14	-13	-11	-10	-6	-3	0	2	2
140	2	2	1	0	-2	-4	-5	-5	-4	-4
150	-3	-2	-2	-2	-3	-6	-7	-6	-3	-3
160	-1	-1	-5	-6	-10	-16	-19	-20	-21	-22
170	-23	-26	-29	-32	-36	-39	-40	-41	-40	-38
180	-33	-29	-27	-26	-23	-19	-16	-13	-11	-11
190	-11	-11	-9	-5	0	2	5	6	8	8
200	8	8	9	10	11	11	10	8	6	6
210	4	2	0	0	1	3	3	3	1	1
220	-2	-5	0	-11	-14	-17	-19	-20	-21	-21
230	-20	-19	-18	-18	-20	-23	-27	-30	-33	-33
240	-35	-35	-33	-31	-28	-25	-24	-23	-21	-21
250	-18	-13	-10	-8	-7	-8	-10	-11	-12	-12
260	-11	-10	-7	-5	-4	-1	1	4	7	9
270	11	9	8	5	1	-1	-5	-8	-11	-13
280	-14	-16	-19	-20	-20	-20	-20	-20	-21	-21
290	-21	-21	-22	-23	-26	-27	-27	-26	-23	-18
300	-12	-7	-2	4	4	4	4	2	0	-3
310	-7	-11	-13	-15	-16	-14	-10	-6	-1	4
320	8	12	14	14	13	10	6	2	0	-1
330	-3	-3	-2	0	-1	-2	-3	-5	-9	-9
340	-13	-20	-26	-31	-35	-37	-36	-34	-31	-27
350	-23	-19	-16	-12	-10	-8	-8	-10	-11	-13
360	-15	-14	-12	-9	-7	-5	-4	-3	-2	-2
370	-2	-3	-3	-3	-1	2	5	7	9	11
380	13	14	15	16	15	14	15	18	16	16
390	15	12	9	2	-5	-11	-15	-20	-23	-26
400	-30	-33	-34	-35	-34	-32	-30	-28	-24	-24
410	-22	-20	-19	-18	-17	-18	-20	-21	-21	-21
420	-21	-23	-25	-25	-22	-17	-9	-1	5	10
430	15	19	20	21	20	18	14	11	9	6
440	4	4	5	5	12	12	12	12	11	11
450	6	0	-6	-12	-19	-27	-32	-38	-43	-45
460	-45	-42	-36	-27	-19	-13	-11	-11	-12	-12
470	-14	-15	-16	-16	-13	-9	-2	4	9	12
480	13	13	11	8	5	2	-1	-4	-6	-7

TO BE CONTINUED

TO BE CONTINUED

	(1)	(2)	(3)	(4)	(5)	(6)	(7)	(8)	(9)	(10)
1030	9	-4	-17	-25	-32	-39	-45	-53	-56	-62
1040	-68	-75	-84	-90	-98	-108	-117	-124	-130	-133
1050	-137	-142	-149	-155	-162	-168	-172	-174	-177	-174
1060	-164	-150	-135	-118	-96	-73	-50	-28	-11	14
1070	33	49	64	80	94	107	121	136	154	172
1080	192	213	234	254	263	265	257	269	266	260
1090	250	236	222	206	189	170	148	122	98	79
1100	41	42	21	-8	-43	-77	-121	-177	-231	-278
1110	-313	-330	-331	-329	-332	-330	-321	-312	-301	-285
1120	-266	-250	-240	-235	-236	-241	-249	-272	-279	-281
1130	-279	-268	-248	-222	-188	-148	-111	-77	-47	-17
1140	-85	-8	-8	-12	-24	-39	-58	-73	-82	-85
1150	-10	-66	-45	-14	24	65	106	136	149	151
1160	144	126	93	50	9	-22	-45	-58	-70	-64
1170	-54	1	31	58	75	82	83	80	57	53
1180	53	15	3	-2	-5	-2	7	24	52	82
1190	104	117	121	117	104	79	44	0	-47	-98
1200	-152	-202	-243	-272	-288	-293	-289	-274	-243	-200
1210	-156	-124	-105	-97	-99	-109	-127	-152	-178	-199
1220	-213	-219	-217	-203	-174	-127	-69	-5	54	100
1230	138	140	140	132	115	93	72	55	40	32
1240	33	44	60	80	101	120	134	140	141	138
1250	159	113	93	68	36	3	-24	-45	-60	-65
1260	-63	-52	-33	-6	23	47	67	85	95	99
1270	96	84	62	36	8	-16	-30	-36	-34	-22
1280	-5	13	39	62	73	74	72	63	47	27
1290	9	-5	-19	-28	-30	-25	-11	12	40	72
1300	110	152	185	203	212	214	212	204	189	165
1310	136	107	76	40	0	-44	-85	-115	-136	-146
1320	-148	-145	-136	-125	-118	-117	-119	-124	-129	-134
1330	-138	-137	-129	-113	-88	-55	-18	12	35	49
1340	56	55	49	36	18	-3	-26	-46	-63	-75
1350	-80	-76	-63	-43	-20	8	4	28	53	74
1360	94	98	99	98	92	80	64	43	23	8
1370	-12	-26	-36	-42	-47	-51	-54	-55	-58	-68
1380	-85	-107	-110	-155	-174	-187	-193	-192	-185	-169
1390	-149	-128	-110	-97	-89	-85	-83	-82	-83	-87
1400	-68	-87	-80	-64	-42	-16	8	9	33	68
1410	80	86	88	88	85	78	67	50	33	33
1420	3	-1	0	8	25	51	89	132	166	191
1430	200	199	190	170	139	100	64	40	22	12
1440	13	23	45	72	101	122	130	131	126	115
1450	96	71	59	5	-24	-49	-69	-82	-88	-90
1460	-88	-81	-69	-51	-31	-18	-12	-12	-18	-32
1470	-50	-70	-86	-93	-95	-91	-75	-53	-34	-19
1480	-4	9	21	27	27	25	21	12	-1	-11
1490	-18	-24	-24	-28	-33	-17	-10	-4	2	9
1500	16	22	25	29	30	31	29	24	18	10
1510	3	0	2	-4	-6	-8	-12	-17	-22	-28
1520	-31	-29	-26	-23	-16	-9	-4	-2	-1	2
1530	7	12	23	31	38	46	53	61	68	73
1540	80	87	93	99	102	102	99	93	85	77
1550	68	64	62	62	62	67	71	73	73	71
1560	66	62	55	51	48	46	42	37	33	27

TO BE CONTINUED

	(1)	(2)	(3)	(4)	(5)	(6)	(7)	(8)	(9)	(10)
1570	19	11	2	-11	-28	-50	-74	-96	-120	-144
1580	-164	-182	-200	-208	-211	-211	-203	-186	-168	-146
1590	-123	-101	-82	-64	-48	-33	-20	-5	11	31
1600	56	88	123	153	181	202	219	232	240	247
1610	255	263	269	278	287	294	300	304	303	299
1620	292	286	276	261	245	229	213	192	166	143
1630	132	100	78	55	28	3	-26	-63	-103	-143
1640	-176	-211	-241	-270	-297	-321	-342	-358	-370	-378
1650	-381	-378	-367	-347	-322	-293	-260	-230	-207	-187
1660	-169	-154	-140	-125	-109	-82	-46	-7	29	59
1670	96	138	149	162	169	176	179	176	172	167
1680	161	157	152	146	140	135	128	118	109	91
1690	66	63	65	69	-35	-81	-86	-106	-121	-132
1700	-139	-146	-149	-153	-157	-159	-163	-168	-174	-178
1710	-184	-188	-188	-183	-170	-150	-129	-108	-87	-65
1720	-41	-21	-8	4	17	29	40	51	61	71
1730	80	86	86	83	78	74	72	72	72	78
1740	92	98	102	103	102	99	94	87	79	72
1750	61	52	52	48	44	41	42	42	41	59
1760	41	42	43	42	39	36	31	23	16	8
1770	-2	-8	-10	-8	-2	4	11	18	21	21
1780	18	13	5	-7	-13	-17	-22	-23	-22	-21
1790	-20	-20	-22	-22	-25	-31	-32	-36	-42	-49
1800	-54	-58	-63	-65	-67	-71	-71	-70	-67	-63
1810	-61	-60	-57	-57	-57	-57	-55	-49	-38	-23
1820	-6	11	28	45	61	71	80	88	94	100
1830	107	115	127	144	163	188	221	255	289	319
1840	346	370	381	381	373	351	311	260	207	157
1850	103	54	4	-50	-95	-129	-161	-184	-202	-213
1860	-226	-244	-263	-284	-311	-341	-370	-390	-402	-412
1870	-415	-408	-393	-369	-337	-295	-249	-211	-170	-129
1880	-94	-67	-45	-25	-11	2	13	25	40	56
1890	74	91	116	145	171	198	220	238	249	257
1900	261	259	257	248	238	227	216	209	207	212
1910	222	234	245	257	264	266	266	261	250	231
1920	205	174	144	115	80	45	15	-10	-40	-73
1930	-105	-136	-164	-197	-227	-250	-276	-295	-305	-308
1940	-310	-308	-303	-298	-295	-292	-288	-285	-277	-264
1950	-246	-223	-195	-163	-129	-87	-60	-44	-24	83
1960	116	145	178	204	221	230	232	230	224	213
1970	201	190	180	170	165	164	167	168	169	169
1980	170	168	162	153	142	126	111	95	73	47
1990	18	-4	-24	-41	-52	-58	-60	-58	-56	-57
2000	-61	-71	-83	-99	-117	-135	-148	-158	-165	-167
2010	-163	-155	-143	-129	-113	-94	-76	-58	-41	-24
2020	-8	5	17	26	33	38	43	47	55	64
2030	73	83	91	95	96	88	81	74	64	64
2040	54	48	43	37	32	29	25	20	15	6
2050	-6	-17	-29	-45	-66	-86	-102	-117	-129	-138
2060	-141	-142	-140	-136	-131	-127	-123	-120	-118	-115
2070	-113	-109	-107	-104	-101	-97	-91	-86	-80	-74
2080	-69	-65	-64	-62	-62	-60	-58	-50	-34	-10
2090	24	60	101	149	189	222	251	273	289	294
2100	292	289	279	265	245	217	189	166	145	125

TO BE CONTINUED

	NO.	(1)	(2)	(3)	(4)	(5)	(6)	(7)	(8)	(9)	(10)	(11)	(12)	(13)	(14)	(15)	(16)	(17)	(18)	(19)	(20)	(21)	(22)	(23)	(24)	(25)	(26)	(27)	(28)	(29)	(30)	(31)	(32)	(33)	(34)	(35)	(36)	(37)	(38)	(39)	(40)
2110	108	94	83	74	65	53	41	27	11	-5	-5	11	106	111	116	114	114	110	105	97	84																				
2120	-27	-52	-78	-106	-134	-167	-177	-183	-183	-183	-183	68	51	31	14	-2	-14	-14	-36	-41	-42																				
2130	-174	-159	-137	-112	-86	-63	-43	-28	-19	-16	-16	-42	-38	-30	-24	-19	-12	-7	-2	2	6																				
2140	-16	-17	-20	-20	-20	-18	-16	-11	-2	7	7	2680	10	12	16	21	25	27	31	36	36																				
2150	20	33	45	60	77	99	96	101	101	98	98	2690	38	42	46	48	48	47	44	40	35																				
2160	91	84	75	66	48	40	32	26	19	19	19	2700	29	24	21	19	18	18	20	21	22																				
2170	12	8	2	-3	-7	-10	-12	-14	-17	-17	-17	2710	22	20	15	10	4	-3	-11	-21	-41																				
2180	-21	-27	-35	-44	-54	-63	-73	-84	-96	-105	-105	2720	-51	-61	-70	-75	-77	-80	-80	-76	-73																				
2190	-111	-118	-125	-131	-132	-138	-120	-105	-80	-46	-46	2730	-73	-72	-71	-72	-71	-63	-69	-67	-63																				
2200	-11	22	51	79	102	118	120	118	110	94	94	2740	-58	-47	-37	-18	1	24	67	65	77																				
2210	72	46	21	0	-17	-32	-45	-54	-58	-59	-59	2750	101	106	108	108	108	103	97	92	87																				
2220	-55	-45	-31	-17	-3	10	24	35	40	40	40	2760	76	71	67	62	58	53	48	41	32																				
2230	37	28	15	0	-12	-24	-32	-38	-40	-39	-24	2770	11	2	-6	-11	-16	-20	-21	-22	-25																				
2240	-36	-32	-29	-31	-33	-36	-41	-47	-52	-52	-52	2780	-23	-22	-25	-27	-28	-31	-35	-39	-44																				
2250	-53	-52	-50	-45	-38	-31	-23	-15	-4	8	8	2790	-46	-43	-40	-34	-3	34	61	85	107																				
2260	17	26	32	37	39	38	34	29	24	19	19	2800	128	146	158	167	175	181	186	188	190																				
2270	18	16	18	23	29	34	36	33	25	24	24	2810	193	193	193	194	194	194	193	189	184																				
2280	-2	-23	-46	-70	-95	-119	-140	-154	-162	-165	-165	2820	168	156	142	127	108	93	80	64	51																				
2290	-163	-158	-151	-143	-131	-118	-109	-103	-99	-96	-96	2830	23	6	-10	-24	-40	-55	-69	-83	-96																				
2300	-96	-98	-98	-98	-97	-91	-81	-66	-46	-13	-13	2840	-125	-138	-148	-158	-167	-177	-186	-193	-200																				
2310	30	76	120	175	233	278	313	340	329	312	312	2850	-207	-211	-213	-213	-213	-210	-205	-197	-186																				
2320	385	389	388	384	378	367	356	343	329	312	312	2860	-172	-157	-138	-109	-80	-49	-19	14	52																				
2330	294	276	255	230	205	179	150	113	70	27	27	2870	117	145	175	204	224	241	257	271	286																				
2340	-14	-57	-105	-152	-197	-246	-294	-336	-370	-394	-394	2880	306	312	317	320	324	327	327	326	317																				
2350	-18	-436	-645	-850	-1052	-1247	-1449	-1642	-1822	-2000	-2000	2890	309	299	286	271	254	237	220	201	183																				
2360	-418	-400	-374	-335	-291	-247	-199	-139	-76	-17	-17	2900	146	130	113	94	76	56	37	19	2																				
2370	39	97	157	215	261	296	327	356	386	415	415	2910	-49	-43	-59	-75	-87	-98	-108	-117	-126																				
2380	444	472	505	537	561	584	597	599	594	576	576	2920	-138	-142	-142	-140	-137	-135	-131	-125	-121																				
2390	544	503	454	399	344	291	236	176	111	54	54	2930	-107	-97	-85	-73	-60	-46	-31	-19	-2																				
2400	14	-20	-50	-72	-89	-106	-123	-144	-171	-204	-204	2940	20	40	56	69	79	86	91	93	92																				
2410	-243	-287	-325	-355	-382	-407	-427	-442	-447	-449	-449	2950	82	71	60	45	29	12	-3	-16	-28																				
2420	-448	-442	-435	-422	-398	-371	-339	-306	-271	-234	-234	2960	-51	-59	-66	-74	-82	-89	-97	-108	-119																				
2430	-198	-161	-122	-86	-54	-23	5	35	66	100	100	2970	-141	-152	-160	-165	-168	-167	-162	-153	-143																				
2440	131	159	182	201	218	232	241	247	251	252	252	2980	-111	-95	-78	-61	-41	-22	-7	6	20																				
2450	253	254	254	253	254	256	254	251	251	250	250	2990	53	68	85	104	126	146	165	184	197																				
2460	267	245	242	237	228	213	191	166	141	115	115	3000	217	227	233	236	239	242	231	225	216																				
2470	87	60	37	20	6	-3	-12	-19	-27	-34	-34	3010	195	180	163	148	132	113	95	78	60																				
2480	-40	-48	-57	-65	-73	-82	-90	-98	-107	-114	-114	3020	19	-2	-24	-49	-69	-86	-102	-113	-124																				
2490	-120	-125	-131	-137	-142	-145	-144	-143	-143	-139	-139	3030	-139	-142	-145	-146	-146	-144	-139	-131	-121																				
2500	-132	-122	-111	-100	-87	-72	-58	-43	-30	-18	-18	3040	-102	-93	-81	-69	-58	-49	-39	-30	-21																				
2510	-9	-1	3	6	9	11	13	13	13	13	13	3050	-2	9	25	43	58	72	84	99	112																				
2520	13	14	15	18	20	23	25	27	29	29	29	3060	124	128	130	129	128	128	127	125	121																				
2530	33	36	40	46	53	62	72	80	88	94	94	3070	112	109	103	96	89	85	82	78	72																				
2540	96	97	95	92	86	83	80	75	72	69	69	3080	57	48	37	19	-3	-25	-51	-78	-100																				
2550	68	67	67	67	70	71	72	70	69	67	69	3090	-143	-163	-176	-188	-199	-205	-208	-210	-209																				
2560	69	68	65	62	59	59	60	63	67	70	70	3100	-204	-197	-190	-182	-176	-170	-165	-159	-151																				
2570	71	75	77	78	78	77	75	69	62	52	52	3110	-129	-117	-106	-95	-81	-67	-58	-47	-32																				
2580	41	28	15	2	-8	-19	-28	-36	-45	-53	-53	3120	-7	7	20	30	42	52	62	69	75																				
2590	-59	-64	-68	-73	-76	-79	-80	-79	-77	-74	-74	3130	82	86	86	88	92	97	101	103	105																				
2600	-69	-60	-48	-35	-20	-9	4	14	21	26	26	3140	105	105	105	105	105	104	103	102	101																				
2610	28	50	51	50	28	25	23	22	21	26	26	3150	97	95	93	90	87	83	78	74	68																				
2620	29	31	36	40	43	45	46	44	40	33	33	3160	52	38	25	11	-4	-18	-34	-50	-65																				
2630	26	18	8	-2	-11	-14	-14	-14	-10	-6	-6	3170	-86	-93	-100	-106	-112	-117	-120	-127	-130																				
2640	0	7	20	31	39	48	58	68	80	91	91	3180	-131	-134	-136	-136	-137	-138	-137	-134	-131																				

TO BE CONTINUED

TO BE CONTINUED

CONTINUED (S-2112 N33E)

NO.	(1)	(2)	(3)	(4)	(5)	(6)	(7)	(8)	(9)	(10)
3190	-122	-116	-109	-103	-95	-86	-78	-70	-60	-69
3200	-59	-30	-21	-12	-4	4	13	21	31	41
3210	49	58	67	74	79	83	83	81	78	72
3220	62	52	41	30	21	14	5	-2	-8	-13
3230	-18	-25	-33	-41	-49	-56	-62	-67	-73	-78
3240	-83	-88	-92	-96	-98	-100	-100	-99	-97	-95
3250	-87	-89	-88	-91	-93	-14	10	38	64	89
3260	113	135	158	180	197	211	224	236	245	251
3270	253	253	251	248	243	234	222	210	197	182
3280	163	143	123	102	79	55	31	8	-16	-43
3290	-72	-100	-128	-153	-177	-200	-218	-232	-245	-255
3300	-243	-249	-274	-275	-273	-268	-261	-249	-235	-218
3310	-198	-177	-156	-135	-112	-93	-73	-51	-28	-4
3320	15	53	51	66	81	97	110	122	132	142
3330	152	160	166	170	176	182	189	196	201	206
3340	212	216	219	221	221	219	214	208	199	185
3350	164	140	111	83	53	22	-5	-29	-49	-66
3360	-79	-88	-96	-103	-108	-112	-115	-117	-119	-121
3370	-123	-126	-127	-130	-133	-131	-130	-128	-124	-117
3380	-103	-90	-75	-60	-42	-23	-5	10	28	43
3390	55	64	71	75	77	77	75	72	68	63
3400	57	50	41	28	15	-13	-30	-48	-67	-81
3410	-85	-102	-118	-132	-145	-153	-159	-165	-168	-168
3420	-167	-167	-165	-161	-154	-145	-133	-123	-113	-85
3430	-63	-38	-15	5	27	47	61	71	79	86
3440	90	93	93	95	96	100	102	106	111	116
3450	120	122	125	129	131	131	130	127	122	116
3460	110	105	100	94	89	85	81	78	76	74
3470	70	67	63	60	58	54	49	47	43	39
3480	38	37	34	32	31	30	29	28	27	24
3490	22	17	12	8	3	0	-4	-7	-9	-10
3500	-10	-10	-10	-8	-4	0	2	5	10	13
3510	16	20	22	25	28	31	34	36	40	44
3520	47	50	51	49	48	47	43	39	32	26
3530	17	7	-2	-11	-19	-29	-40	-50	-58	-66
3540	-73	-79	-87	-94	-100	-105	-111	-114	-116	-118
3550	-117	-115	-110	-102	-93	-81	-64	-43	-25	-6
3560	13	28	42	54	63	71	79	85	93	102
3570	109	115	122	128	132	135	140	145	144	145
3580	143	141	137	132	128	124	117	112	108	103
3590	96	88	80	72	60	47	31	14	-2	-21
3600	-43	-62	-81	-98	-111	-122	-129	-135	-138	-137
3610	-136	-132	-128	-124	-119	-112	-107	-102	-96	-91
3620	-87	-80	-71	-62	-51	-40	-24	-8	7	24
3630	40	58	76	88	98	108	116	122	128	132
3640	136	139	142	142	142	143	143	142	141	138
3650	135	128	118	106	92	75	58	40	21	4
3660	-11	-30	-49	-66	-81	-98	-116	-130	-142	-154
3670	-166	-176	-184	-191	-197	-203	-207	-210	-211	-211
3680	-211	-211	-209	-204	-196	-184	-173	-162	-144	-124
3690	-103	-77	-47	-14	11	42	77	110	137	163
3700	190	213	233	247	256	265	271	273	274	273
3710	268	262	255	249	242	237	230	225	216	208
3720	199	188	174	157	140	122	101	79	60	39

TO BE CONTINUED

CONTINUED (S-2112 N33E)

NO.	(1)	(2)	(3)	(4)	(5)	(6)	(7)	(8)	(9)	(10)
3740	9	-15	-34	-51	-67	-82	-97	-108	-118	-127
3750	-133	-141	-148	-153	-155	-158	-158	-157	-155	-152
3760	-77	-64	-50	-36	-132	-126	-119	-111	-102	-91
3770	14	18	20	25	29	30	35	40	45	48
3780	51	58	66	73	78	79	81	83	84	86
3790	91	93	93	93	93	94	95	98	103	106
3800	109	110	114	114	115	114	110	106	103	103
3810	99	93	85	78	70	61	51	38	25	13
3820	1	-8	-19	-31	-42	-54	-66	-75	-83	-92
3830	-101	-109	-114	-117	-121	-123	-123	-121	-119	-118
3840	-115	-109	-103	-98	-93	-87	-83	-77	-71	-64
3850	-59	-53	-45	-36	-28	-17	-6	5	11	19
3860	30	43	50	56	60	66	72	77	79	81
3870	84	84	84	84	84	80	77	71	63	57
3880	50	40	29	18	5	-4	-12	-23	-35	-45
3890	-54	-63	-74	-84	-95	-108	-119	-130	-142	-149
3900	-156	-158	-158	-155	-152	-147	-138	-126	-115	-103
3910	-90	-78	-64	-52	-43	-33	-24	-15	-7	0
3920	6	13	19	23	26	28	29	28	28	28
3930	28	25	21	18	16	14	14	13	15	17
3940	19	21	26	29	33	38	41	44	47	49
3950	49	49	50	51	51	50	50	49	46	42
3960	37	34	34	32	28	24	20	16	11	4
3970	-1	-6	-10	-16	-21	-26	-32	-35	-38	-42
3980	-45	-46	-47	-49	-49	-49	-49	-49	-50	-51
3990	-52	-54	-55	-54	-52	-49	-45	-39	-33	-27
4000	-17	-9	-1	8	18	28	39	48	55	61
4010	68	76	82	88	93	97	100	103	106	107
4020	108	106	103	99	93	87	79	67	55	41
4030	30	18	4	-9	-24	-37	-50	-63	-76	-85
4040	-96	-106	-114	-121	-127	-132	-135	-138	-139	-139
4050	-139	-138	-136	-132	-127	-120	-113	-104	-94	-83
4060	-73	-61	-45	-30	-15	-2	10	26	43	57
4070	68	84	100	112	125	139	153	165	172	177
4080	183	189	190	192	193	193	193	190	186	180
4090	172	164	153	141	125	107	89	71	48	23
4100	0	-18	-36	-54	-72	-88	-101	-113	-124	-134
4110	-141	-147	-151	-155	-159	-164	-166	-168	-170	-170
4120	-171	-171	-170	-166	-161	-154	-147	-141	-130	-119
4130	-108	-98	-86	-72	-57	-43	-28	-12	5	18
4140	31	45	57	68	79	87	96	104	110	114
4150	117	119	121	120	116	110	104	94	80	67
4160	53	39	24	11	0	-6	-13	-20	-26	-33
4170	-41	-47	-53	-58	-62	-66	-66	-66	-66	-66
4180	-69	-65	-61	-56	-48	-39	-28	-17	-9	-1
4190	6	17	26	32	39	45	49	52	55	57
4200	58	59	58	57	54	50	44	38	32	25
4210	17	11	5	0	-7	-14	-19	-23	-28	-32
4220	-34	-35	-36	-38	-39	-41	-45	-47	-48	-50
4230	-53	-55	-57	-58	-58	-58	-58	-57	-55	-53
4240	-49	-44	-39	-33	-28	-23	-18	-13	-8	-4
4250	0	3	6	8	9	10	11	13	13	13
4260	13	14	15	15	15	15	15	15	15	15

TO BE CONTINUED

CONTINUED (S-2112 M33E)

	(1)	(2)	(3)	(4)	(5)	(6)	(7)	(8)	(9)	(10)
4270	-16	-24	-32	-41	-52	-62	-70	-77	-82	-86
4280	-90	-94	-98	-98	-98	-98	-98	-96	-93	-89
4290	-81	-76	-70	-63	-56	-48	-38	-31	-22	-12
4300	-1	7	14	20	30	42	52	60	70	80
4310	91	100	108	117	124	129	133	136	138	138
4320	136	133	128	119	114	109	106	106	106	106
4330	105	104	105	105	104	102	98	94	87	81
4340	80	71	63	54	46	38	32	28	22	18
4350	15	13	10	7	4	0	-3	-7	-10	-13
4360	-17	-20	-24	-27	-29	-31	-33	-34	-35	-35
4370	-36	-37	-39	-41	-44	-46	-49	-52	-55	-58
4380	-52	-49	-43	-34	-24	-16	-9	-2	2	9
4390	4	6	8	6	2	-2	-4	-6	-7	-9
4400	-10	-11	-11	-10	-9	-8	-9	-11	-16	-20
4410	-24	-27	-32	-36	-38	-39	-40	-40	-39	-38
4420	-37	-34	-32	-29	-27	-26	-24	-19	-13	-8
4430	-6	0	7	15	23	29	35	40	44	47
4440	49	49	49	49	48	47	45	43	41	41
4450	42	43	44	46	47	46	43	39	35	29
4460	23	17	11	5	-2	-9	-14	-20	-23	-27
4470	-43	-33	-34	-35	-38	-40	-40	-43	-43	-43
4480	-31	-43	-42	-40	-38	-29	-27	-24	-18	-13
4490	-9	-4	0	5	12	17	24	32	38	44
4500	47	49	52	56	60	62	61	61	60	58
4510	55	50	44	39	32	23	14	4	-5	-10
4520	-14	-23	-31	-39	-46	-53	-57	-59	-60	-59
4530	-57	-55	-50	-45	-41	-36	-32	-27	-22	-17
4540	-2	5	11	15	22	30	35	40	43	47
4550	51	53	57	59	59	62	63	63	61	57
4560	56	56	53	51	48	43	38	32	28	24
4570	19	13	8	1	-4	-11	-18	-24	-31	-38
4580	-44	-48	-52	-55	-57	-58	-59	-60	-60	-60
4590	-56	-55	-53	-51	-46	-40	-35	-32	-26	-22
4600	-18	-12	-9	-6	-3	0	6	12	16	19
4610	23	26	29	32	32	29	28	31	27	22
4620	17	13	8	3	-2	-10	-16	-24	-32	-40
4630	-67	-62	-60	-66	-72	-75	-78	-80	-82	-83
4640	-85	-85	-85	-85	-85	-85	-85	-85	-85	-85
4650	-74	-83	-88	-91	-94	-97	-101	-104	-102	-101
4660	74	83	88	91	94	97	101	104	102	101
4670	100	97	92	83	74	63	53	40	26	13
4680	0	-12	-25	-38	-51	-60	-68	-77	-86	-92
4690	-97	-100	-103	-107	-109	-110	-111	-114	-115	-115
4700	-114	-111	-107	-104	-99	-92	-86	-79	-71	-63
4710	-35	-44	-45	-43	-36	-26	-16	-10	-6	-2
4720	30	37	43	48	52	57	60	64	68	72
4730	70	71	73	73	74	76	76	78	78	80
4740	81	80	81	81	81	81	81	81	79	78
4750	78	78	78	76	75	76	76	75	79	79
4760	79	81	81	81	80	80	80	79	78	74
4770	70	68	64	59	55	50	45	34	26	21
4780	14	-1	-8	-14	-20	-27	-37	-47	-57	-67
4790	-67	-76	-86	-96	-108	-116	-124	-129	-133	-136
4800	-136	-136	-136	-134	-133	-129	-123	-114	-105	-94

TO BE CONTINUED

CONTINUED (S-2112 M33E)

	(1)	(2)	(3)	(4)	(5)	(6)	(7)	(8)	(9)	(10)
4810	-81	-69	-56	-42	-29	-16	-4	8	20	30
4820	36	42	47	51	57	65	70	75	79	81
4830	85	88	86	89	89	88	88	84	79	75
4840	69	63	56	49	44	35	25	18	12	5
4850	-1	-6	-11	-18	-23	-30	-36	-41	-46	-49
4860	-53	-57	-59	-60	-60	-62	-63	-60	-58	-54
4870	-53	-48	-43	-40	-38	-35	-30	-27	-23	-17
4880	-12	-6	-3	-3	0	2	4	4	4	4
4890	5	0	-1	-1	0	0	0	0	0	0
4900	2	4	5	7	10	12	17	21	24	26
4910	31	35	36	39	44	49	50	50	53	55
4920	55	54	53	52	50	48	44	42	40	38
4930	34	30	23	18	15	9	2	-3	-8	-14
4940	-20	-25	-30	-33	-39	-45	-53	-58	-64	-70
4950	-74	-79	-84	-89	-92	-94	-93	-92	-90	-89
4960	-89	-86	-82	-80	-78	-78	-77	-75	-75	-75
4970	-75	-72	-70	-68	-65	-61	-56	-49	-43	-37
4980	-39	-21	-12	-4	1	7	14	20	26	31
4990	36	43	48	52	57	64	71	77	82	84
5000	84	84	84	85	85	84	80	77	73	66
5010	60	54	48	41	34	29	22	15	7	0
5020	-7	-15	-20	-27	-32	-36	-40	-42	-43	-44
5030	-66	-67	-66	-64	-64	-63	-62	-61	-60	-59
5040	-40	-39	-38	-37	-35	-29	-25	-18	-12	-7
5050	-4	0	3	4	4	4	2	0	-1	-3
5060	-7	-8	-11	-13	-16	-19	-21	-21	-21	-22
5070	-23	-24	-23	-22	-20	-19	-15	-11	-8	-5
5080	1	4	8	11	15	20	25	25	26	27
5090	30	30	28	27	26	25	21	18	13	8
5100	4	0	-5	-9	-11	-15	-21	-26	-29	-29
5110	-32	-35	-37	-37	-36	-38	-38	-34	-31	-28
5120	-27	-25	-20	-15	-13	-10	-6	-4	-1	0
5130	2	3	6	8	10	12	16	20	24	27
5140	29	32	34	35	34	30	26	24	23	21
5150	17	13	9	5	2	0	-2	-7	-10	-10
5160	-12	-16	-21	-25	-29	-32	-36	-40	-42	-43
5170	-44	-47	-48	-47	-45	-42	-40	-37	-33	-28
5180	-23	-18	-12	-8	-4	2	7	14	20	26
5190	33	39	42	47	52	55	58	61	66	69
5200	70	69	67	65	62	59	53	47	40	36
5210	31	25	16	8	1	-4	-8	-11	-16	-22
5220	-7	-5	-6	-2	1	4	11	16	22	28
5230	-71	-75	-78	-79	-80	-79	-84	-84	-83	-83
5240	-81	-78	-74	-69	-64	-60	-53	-46	-40	-34
5250	-29	-26	-22	-18	-13	-6	2	5	11	18
5260	23	28	34	36	38	41	45	48	52	57
5270	61	66	68	71	76	78	80	82	84	87
5280	91	95	98	101	103	105	105	105	105	105
5290	105	103	99	95	90	83	73	62	53	44
5300	31	17	5	-4	-16	-29	-42	-56	-70	-82
5310	-93	-103	-112	-122	-132	-139	-143	-148	-152	-155
5320	-156	-157	-158	-155	-151	-148	-143	-138	-132	-123
5330	-115	-105	-95	-85	-78	-69	-59	-48	-38	-29
5340	-21	-10	6	12	18	24	30	37	43	45

TO BE CONTINUED

CONTINUED (S-2112 N33E)

NO.	(1)	(2)	(3)	(4)	(5)	(6)	(7)	(8)	(9)	(10)
5350	49	53	56	58	59	60	59	57	55	53
5360	50	46	43	41	38	33	27	22	16	10
5370	4	0	-5	-11	-29	-22	-27	-29	-29	-29
5380	-30	-32	-29	-28	-27	-26	-24	-20	-17	-15
5390	-14	-13	-12	-9	-6	-2	0	5	12	19
5400	26	33	41	48	53	56	59	62	63	64
5410	64	64	64	59	53	49	46	40	35	30
5420	24	18	13	4	-4	-12	-17	-23	-28	-33
5430	-39	-42	-45	-49	-53	-55	-56	-55	-56	-56
5440	-56	-53	-52	-51	-49	-44	-38	-33	-26	-19
5450	-14	-8	-1	8	18	27	37	48	55	62
5460	67	72	78	81	85	89	93	96	99	100
5470	100	99	99	99	98	94	91	90	84	78
5480	72	64	46	37	26	14	4	-4	-12	-14
5490	-19	-29	-38	-44	-51	-59	-65	-70	-73	-78
5500	-81	-83	-84	-84	-84	-82	-79	-77	-72	-64
5510	-58	-53	-48	-39	-30	-21	-14	-6	0	5
5520	14	21	25	31	37	42	44	43	45	46
5530	46	45	42	40	37	34	29	23	17	11
5540	6	-2	-9	-17	-25	-31	-37	-43	-49	-54
5550	-59	-64	-70	-74	-76	-78	-79	-79	-77	-73
5560	-67	-62	-61	-56	-48	-39	-31	-25	-16	-7
5570	0	6	13	22	30	36	43	49	58	67
5580	74	80	85	91	98	104	110	114	119	119
5590	122	123	124	126	124	122	121	119	115	110
5600	104	101	97	93	88	81	75	66	57	46
5610	40	30	20	10	-9	-18	-29	-40	-46	-46
5620	-52	-59	-66	-74	-80	-89	-96	-102	-109	-115
5630	-119	-122	-124	-127	-128	-129	-129	-127	-124	-124
5640	-121	-116	-111	-107	-102	-96	-85	-77	-70	-59
5650	-50	-43	-38	-32	-24	-16	-8	1	8	15
5660	22	33	44	52	58	63	68	72	78	83
5670	87	91	90	90	93	92	90	86	83	80
5680	75	68	62	57	53	47	37	31	26	20
5690	13	6	0	-8	-17	-23	-29	-37	-43	-48
5700	-53	-56	-58	-62	-64	-64	-64	-62	-59	-55
5710	-53	-51	-44	-39	-33	-27	-20	-12	-7	0
5720	8	14	20	26	33	38	43	49	54	60
5730	61	63	65	68	64	65	64	59	55	51
5740	46	39	29	19	11	0	-10	-23	-33	-44
5750	-55	-67	-75	-80	-85	-92	-98	-103	-106	-110
5760	-111	-111	-111	-111	-110	-108	-105	-99	-92	-84
5770	-75	-68	-56	-41	-30	-18	-4	8	19	30
5780	40	46	51	59	66	71	76	83	86	91
5790	94	96	100	101	100	99	96	96	96	93
5800	85	78	70	62	52	42	31	21	11	-1
5810	-12	-20	-30	-42	-57	-68	-77	-87	-96	-105
5820	-111	-115	-120	-123	-126	-129	-128	-124	-120	-114
5830	-108	-100	-91	-76	-62	-48	-32	-15	3	16
5840	29	48	65	80	99	117	132	145	155	165
5850	175	185	190	194	199	201	204	206	206	203
5860	200	199	194	187	180	170	159	148	134	119
5870	104	86	68	52	34	19	-9	-25	-41	-54
5880	-52	-60	-73	-92	-104	-113	-122	-128	-136	-141

END

TO BE CONTINUED

RECORD = S-2112 COMPONENT = W33N STATION = KEIHN-JI-S
 DATE AND TIME = 1987-12-17-11-08 TOTAL NUMBER OF DATA = 6000
 SAMPLING INTERVAL = 0.010 (SEC) SCAL = 0.10000
 SIGNAL = GR. ACC.
 CONNECTION POINT IN DATA NUMBER = 3008, 6000,

NO.	(1)	(2)	(3)	(4)	(5)	(6)	(7)	(8)	(9)	(10)
490	-37	-27	-17	-7	1	7	10	12	13	13
500	13	13	15	19	24	29	33	37	37	35
510	34	51	27	22	19	16	15	14	13	13
520	13	14	14	12	9	2	-5	-13	-22	-32
530	-48	-47	-50	-52	-52	-48	-42	-38	-34	-30
540	-28	-30	-35	-41	-47	-51	-55	-55	-52	-47
550	-40	-42	-37	-29	-18	9	12	19	21	22
560	21	16	11	10	14	14	18	22	26	30
570	32	33	31	27	19	10	1	-6	-10	-11
580	-11	-10	-6	-1	4	7	8	8	8	6
590	1	-4	-8	-12	-14	-13	-12	-9	-4	-2
600	-3	-2	-2	-4	-6	-8	-7	-6	-5	-5
610	-3	-2	1	4	7	9	7	4	0	0
620	-2	-4	-5	-3	0	4	0	9	11	9
630	6	5	2	-3	-6	-7	-6	-5	-3	0
640	6	13	16	19	19	21	22	20	12	5
650	-5	-12	-17	-19	-21	-21	-17	-13	-11	-9
660	-5	-3	-4	-7	-15	-26	-37	-43	-52	-59
670	-62	-59	-57	-53	-49	-41	-33	-24	-17	-12
680	-7	-3	-1	3	8	12	17	22	27	29
690	32	34	37	41	48	53	57	62	67	68
700	66	60	50	36	22	10	0	-6	-11	-17
710	-22	-23	-24	-27	-31	-35	-39	-42	-45	-47
720	-47	-42	-37	-29	-22	-17	-13	-11	-7	-5
730	-5	-6	-6	-6	-6	-6	-5	-5	-3	0
740	3	8	11	13	17	21	23	23	22	19
750	14	8	2	-6	-14	-24	-32	-37	-41	-42
760	-43	-42	-40	-36	-32	-28	-27	-25	-23	-23
770	-21	-17	-13	-11	-10	-11	-10	-11	-12	-13
780	-16	-20	-20	-20	-20	-20	-20	-20	-20	-20
790	34	29	26	23	21	22	22	24	26	27
800	33	39	43	47	49	48	43	38	30	20
810	10	2	-4	-9	-12	-15	-17	-17	-16	-18
820	-22	-23	-25	-27	-27	-27	-26	-27	-28	-31
830	-31	-30	-30	-29	-26	-24	-19	-15	-11	-9
840	-7	-8	-8	-7	-8	-10	-10	-10	-11	-9
850	0	-2	-6	-8	-11	-16	-18	-17	-14	-6
860	5	20	34	46	56	64	69	70	69	65
870	59	49	36	21	7	-3	-11	-16	-17	-17
880	-13	-11	-11	-11	-11	-11	-11	-11	-11	-11
890	-71	-79	-85	-87	-86	-83	-76	-66	-58	-52
900	-46	-39	-36	-32	-26	-18	-9	4	11	15
910	23	30	36	40	43	46	48	46	43	41
920	38	35	30	26	23	20	15	11	6	0
930	-7	-14	-8	-4	-2	-3	-2	-2	-3	-19
940	-14	-8	-4	-2	-2	-3	-2	-2	-2	-19
950	-3	-5	-8	-9	-10	-11	-11	-9	-5	2
960	-2	-3	-3	-3	-4	-8	-8	-7	-2	9
970	18	28	43	58	72	82	89	98	108	120
980	132	144	156	169	183	194	202	209	211	213
990	214	214	212	207	202	196	191	183	174	168
1000	163	154	146	138	131	122	114	106	98	90
1010	81	71	59	47	32	16	0	-17	-38	-60
1020	-83	-106	-127	-142	-153	-160	-164	-166	-166	-167

TO BE CONTINUED

CONTINUED(S-2112 W33N)

NO.	(1)	(2)	(3)	(4)	(5)	(6)	(7)	(8)	(9)	(10)
1030	-168	-172	-177	-185	-195	-206	-217	-229	-243	-251
1040	-255	-254	-245	-229	-206	-179	-153	-126	-100	-79
1050	-61	-42	-23	-7	9	30	53	77	105	132
1060	153	174	196	214	229	239	245	245	243	239
1070	235	232	230	230	232	231	227	220	207	191
1080	173	153	139	104	76	44	10	-22	-57	-94
1090	-127	-158	-189	-222	-261	-300	-334	-363	-390	-408
1100	-423	-431	-436	-440	-439	-430	-419	-406	-384	-360
1110	-337	-314	-286	-252	-221	-192	-168	-144	-124	-107
1120	-92	-79	-67	-55	-44	-31	-19	-12	-7	-3
1130	-4	-6	-7	-9	-11	-15	-16	-13	-9	-7
1140	-4	-1	0	-1	-7	-17	-30	-45	-58	-67
1150	-74	-81	-86	-88	-88	-86	-80	-71	-62	-55
1160	-51	-49	-48	-44	-40	-38	-36	-34	-31	-27
1170	-23	-16	-9	0	17	39	65	100	142	182
1180	218	247	268	279	281	279	272	259	244	222
1190	198	178	166	146	122	100	78	54	31	9
1200	-41	-74	-106	-137	-163	-184	-199	-208	-211	-211
1210	-204	-188	-163	-136	-111	-89	-69	-53	-42	-36
1220	-33	-32	-30	-27	-21	-7	28	47	64	64
1230	80	92	96	95	90	81	71	57	43	28
1240	17	10	6	5	3	2	2	1	0	0
1250	0	2	3	5	7	9	10	12	19	30
1260	44	61	80	98	112	124	134	142	150	156
1270	161	164	165	164	154	139	118	93	62	26
1280	-13	-53	-69	-118	-140	-152	-155	-151	-139	-122
1290	-107	-100	-100	-108	-124	-144	-165	-176	-186	-190
1300	-187	-177	-162	-157	-149	-136	-124	-114	-101	-86
1310	-77	-94	-108	-117	-120	-114	-97	-72	-37	7
1320	54	88	109	119	121	114	99	78	58	38
1330	20	5	-5	-12	-12	-7	5	23	51	87
1340	124	158	182	194	199	197	187	172	157	144
1350	133	124	115	108	103	96	85	69	50	28
1360	4	-19	-39	-53	-62	-68	-72	-77	-82	-92
1370	-111	-135	-162	-189	-217	-245	-272	-290	-300	-304
1380	-303	-295	-282	-260	-235	-211	-183	-148	-116	-93
1390	-93	-67	-53	-39	-22	-3	18	41	59	75
1400	73	110	122	128	131	129	121	106	85	65
1410	41	27	20	18	19	25	34	43	49	54
1420	57	58	56	51	38	17	-32	-52	-66	-66
1430	-72	-69	-58	-35	5	56	112	165	209	242
1440	261	268	265	247	214	171	123	68	21	-7
1450	-20	-24	-19	-5	14	30	42	48	53	54
1460	51	48	45	45	49	55	60	67	74	80
1470	85	88	89	84	72	53	26	-8	-48	-80
1480	-131	-173	-212	-242	-261	-270	-270	-261	-244	-218
1490	-181	-135	-87	-34	21	68	98	117	129	133
1500	130	121	111	98	86	77	70	66	65	68
1510	74	80	86	90	93	94	93	91	87	83
1520	77	71	66	62	59	58	61	67	82	100
1530	-83	-122	-155	-181	-201	-215	-224	-230	-234	-238
1540	-241	-249	-261	-276	-290	-303	-314	-321	-321	-314
1550	-295	-261	-213	-154	-84	-15	46	106	149	184
1560										

TO BE CONTINUED

CONTINUED(S-2112 W33N)

NO.	(1)	(2)	(3)	(4)	(5)	(6)	(7)	(8)	(9)	(10)
1570	217	244	266	289	312	335	358	378	395	410
1580	420	424	423	417	405	386	362	334	302	266
1590	224	182	137	80	26	-18	-57	-96	-141	-180
1600	-211	-232	-250	-263	-270	-275	-278	-282	-284	-288
1610	-295	-304	-310	-314	-319	-321	-317	-307	-291	-281
1620	-272	-245	-207	-166	-123	-74	-28	6	26	40
1630	53	66	84	103	121	140	160	180	193	206
1640	217	229	242	254	262	270	278	280	282	281
1650	277	271	262	251	239	224	206	189	177	167
1660	158	153	146	138	129	115	96	61	29	-5
1670	-38	-68	-94	-115	-131	-144	-153	-161	-169	-176
1680	-182	-188	-194	-197	-196	-192	-182	-168	-153	-141
1690	-127	-119	-116	-116	-121	-134	-152	-171	-193	-211
1700	-224	-236	-243	-247	-248	-245	-239	-229	-219	-205
1710	-188	-179	-172	-164	-155	-145	-132	-114	-85	-48
1720	-3	54	140	231	276	336	398	443	484	474
1730	475	473	469	462	454	447	441	434	426	418
1740	407	393	374	347	314	277	227	166	98	24
1750	-50	-132	-198	-251	-301	-339	-368	-386	-395	-398
1760	-398	-397	-391	-384	-381	-381	-386	-390	-393	-393
1770	-393	-389	-374	-346	-313	-274	-221	-162	-97	-35
1780	20	92	153	196	244	290	326	355	378	392
1790	400	400	399	395	389	381	367	344	316	287
1800	253	210	160	113	72	35	-22	-67	-108	-150
1810	176	-193	-202	-206	-203	-193	-181	-171	-162	-155
1820	-148	-143	-141	-137	-132	-130	-124	-111	-93	-78
1830	-63	-35	-9	15	43	68	90	110	126	139
1840	150	160	168	175	182	186	188	188	188	181
1850	170	154	134	115	101	88	71	54	38	19
1860	-3	-29	-50	-68	-85	-102	-119	-134	-148	-159
1870	-174	-196	-218	-246	-282	-315	-353	-387	-414	-433
1880	-443	-442	-435	-421	-398	-362	-312	-256	-192	-114
1890	-39	23	76	130	178	216	243	267	292	312
1900	330	346	360	371	381	389	397	402	406	408
1910	407	405	401	390	374	352	327	303	282	256
1920	220	202	179	154	131	106	78	47	11	-56
1930	-63	-103	-138	-173	-206	-235	-272	-312	-346	-377
1940	-405	-429	-445	-454	-458	-459	-457	-452	-441	-424
1950	-407	-385	-352	-325	-296	-259	-220	-184	-133	-73
1960	-15	48	123	192	246	289	317	340	356	365
1970	373	381	387	393	398	401	401	400	392	369
1980	337	298	246	180	113	46	-20	-81	-134	-171
1990	-199	-214	-225	-233	-235	-228	-223	-217	-212	-210
2000	-208	-204	-201	-195	-181	-162	-156	-152	-152	-149
2010	8	43	70	94	114	130	144	155	167	180
2020	190	199	207	211	213	212	209	205	198	189
2030	172	168	163	165	165	166	166	166	166	166
2040	-87	-100	-109	-116	-121	-126	-131	-136	-142	-147
2050	-155	-164	-174	-184	-193	-201	-209	-214	-215	-215
2060	-215	-212	-204	-193	-183	-172	-158	-142	-122	-96
2070	-64	-35	16	57	101	152	203	261	312	341
2080	360	372	378	379	376	371	362	352	340	325
2090	310	293	274	253	229	198	164	133	106	76
2100	46	19	-8	-37	-70	-103	-134	-166	-193	-215

TO BE CONTINUED

CONTINUED(S-2112 W33N)

CONTINUED(S-2112 W33N)

	(1)	(2)	(3)	(4)	(5)	(6)	(7)	(8)	(9)	(10)
2110	-237	-262	-286	-302	-314	-323	-328	-332	-334	-332
2120	-328	-320	-305	-284	-258	-229	-202	-168	-129	-85
2130	-70	-49	-30	-15	-4	6	14	19	25	35
2140	39	44	50	59	70	83	98	116	132	156
2150	150	161	168	174	176	173	168	163	156	142
2160	148	141	135	129	124	119	117	116	112	105
2170	92	84	69	54	40	22	14	8	4	4
2180	2	3	3	2	-1	-8	-15	-22	-30	-34
2190	-37	-37	-34	-30	-26	-18	-12	-8	-5	-5
2200	-5	-9	-14	-17	-23	-30	-36	-43	-50	-55
2210	-32	-32	-34	-37	-47	-64	-84	-107	-134	-154
2220	-167	-174	-177	-174	-162	-142	-121	-98	-76	-58
2230	-43	-33	-26	-21	-19	-16	-12	-9	-4	-4
2240	10	19	27	33	38	41	42	42	41	34
2250	25	13	0	-13	-27	-43	-57	-69	-79	-89
2260	-97	-103	-110	-120	-131	-142	-154	-167	-180	-190
2270	-196	-197	-196	-189	-171	-145	-116	-80	-40	0
2280	44	92	137	180	222	263	297	319	336	350
2290	363	370	375	379	382	380	377	370	357	323
2300	338	314	284	252	220	190	162	134	104	75
2310	45	17	-6	-29	-52	-76	-102	-121	-140	-159
2320	-176	-192	-205	-217	-231	-248	-267	-287	-308	-330
2330	-353	-371	-382	-389	-394	-395	-387	-367	-336	-300
2340	-260	-224	-186	-145	-111	-83	-61	-47	-34	-20
2350	-5	8	25	44	65	88	113	146	184	218
2360	245	270	290	304	310	313	315	313	308	302
2370	294	283	270	258	248	239	228	216	206	198
2380	188	176	160	141	123	105	89	76	62	44
2390	24	5	-14	-34	-58	-82	-108	-134	-155	-173
2400	-188	-201	-210	-215	-218	-218	-218	-215	-212	-210
2410	-207	-206	-204	-202	-201	-202	-202	-203	-206	-208
2420	-206	-198	-183	-166	-147	-123	-93	-60	-24	10
2430	51	92	130	166	200	231	256	279	294	300
2440	305	309	308	305	302	299	297	295	291	291
2450	288	287	285	281	274	263	248	233	219	202
2460	185	166	149	137	125	105	85	64	33	9
2470	-49	-82	-111	-137	-159	-176	-190	-201	-206	-207
2480	-232	-238	-239	-235	-227	-216	-201	-183	-165	-148
2490	-132	-116	-102	-90	-76	-59	-38	-12	11	37
2500	108	136	165	188	205	219	225	229	234	234
2510	237	236	234	229	223	214	200	182	160	142
2520	130	118	106	96	86	75	64	57	54	51
2530	-56	-54	-49	-39	-27	-15	-5	13	14	14
2540	45	36	25	14	1	-13	-28	-40	-50	-55
2550	12	10	8	3	-3	-8	-11	-14	-17	-14
2560	-12	-11	-12	-13	-10	-7	-1	4	12	19
2570	36	43	49	54	57	54	57	53	47	44
2580	28	36	43	49	54	57	54	60	66	74
2590	45	40	38	38	40	47	54	60	66	74
2600	85	93	99	107	112	111	110	110	106	101
2610	260	261	261	261	261	261	261	261	261	261
2620	-17	-19	-20	-20	-18	-16	-15	-12	-11	-10
2630	-10	-8	-7	-7	-6	-7	-5	0	10	22
2640	35	51	69	88	103	117	125	131	133	132

TO BE CONTINUED

TO BE CONTINUED

CONTINUED(S-2112 W33N)

CONTINUED(S-2112 W33N)

NO.	(1)	(2)	(3)	(4)	(5)	(6)	(7)	(8)	(9)	(10)
3190	89	105	119	131	140	149	155	160	166	173
3200	179	184	189	192	194	195	194	191	185	176
3210	165	151	134	114	93	68	38	7	-20	-66
3220	-69	-91	-111	-130	-145	-158	-168	-176	-182	-186
3230	-187	-186	-176	-168	-151	-141	-132	-124	-116	-108
3240	-115	-103	-91	-78	-64	-49	-32	-17	-2	10
3250	23	36	49	61	74	85	104	113	120	129
3260	124	127	128	125	119	111	102	91	79	65
3270	51	39	29	20	13	7	2	0	-3	-7
3280	-12	-16	-19	-22	-22	-20	-18	-15	-10	-5
3290	-7	-3	0	3	4	3	2	1	0	-1
3300	-2	-3	-3	-5	-6	-7	-7	-7	-8	-8
3310	-7	-6	-5	-7	-8	-10	-13	-18	-23	-30
3320	-38	-47	-57	-66	-73	-79	-82	-83	-84	-81
3330	-76	-68	-57	-45	-34	-21	-9	0	10	22
3340	33	66	62	79	96	112	128	141	153	163
3350	170	177	181	183	181	177	173	169	162	152
3360	153	145	136	129	123	119	115	110	101	88
3370	73	55	34	8	-16	-40	-64	-88	-111	-132
3380	-147	-158	-168	-174	-182	-183	-183	-183	-182	-182
3390	-181	-180	-178	-174	-169	-163	-155	-144	-133	-123
3400	-112	-100	-89	-78	-65	-50	-35	-21	-4	12
3410	28	43	56	67	77	86	93	97	99	99
3420	100	99	98	94	89	83	76	69	59	46
3430	32	16	-1	-19	-37	-53	-67	-77	-84	-91
3440	-95	-97	-99	-101	-102	-103	-103	-102	-100	-100
3450	-97	-92	-87	-79	-70	-62	-50	-38	-28	-16
3460	-3	9	20	30	39	48	58	70	82	92
3470	104	116	125	132	139	144	149	151	150	146
3480	142	135	126	115	104	94	83	74	66	60
3490	55	50	48	44	40	36	28	18	9	0
3500	-12	-25	-37	-48	-58	-66	-72	-76	-78	-79
3510	-78	-77	-74	-69	-62	-55	-47	-40	-32	-24
3520	-15	-6	1	11	19	24	31	37	42	47
3530	50	51	52	52	52	50	48	45	40	34
3540	29	23	17	11	5	-4	-12	-21	-27	-33
3550	-59	-44	-31	-17	-1	13	27	40	55	69
3560	-87	-89	-90	-90	-89	-85	-79	-72	-65	-56
3570	-47	-37	-24	-13	0	13	27	40	55	69
3580	81	92	103	113	120	126	131	135	138	142
3590	144	145	148	149	148	144	140	134	127	120
3600	118	108	97	85	71	56	38	22	5	-12
3610	-27	-41	-53	-63	-70	-76	-81	-83	-85	-85
3620	-86	-87	-87	-87	-87	-87	-87	-87	-85	-81
3630	-79	-75	-71	-67	-61	-53	-44	-35	-27	-19
3640	10	0	10	17	22	26	28	30	33	35
3650	36	39	40	43	45	48	50	48	44	41
3660	35	29	20	13	5	-1	-9	-16	-20	-24
3670	-21	-23	-24	-24	-26	-28	-29	-31	-32	-34
3680	-35	-34	-34	-32	-31	-27	-23	-19	-16	-11
3690	-6	-1	3	5	7	9	10	12	12	10
3700	10	11	11	10	11	12	12	11	8	6
3710	3	0	-2	-7	-11	-13	-16	-19	-23	-27
3720	-29	-32	-35	-37	-38	-40	-40	-40	-39	-40
3730	92	96	96	95	95	95	95	95	95	95
3740	86	83	83	83	83	83	83	83	83	83
3750	79	79	79	79	79	79	79	79	79	79
3760	72	72	72	72	72	72	72	72	72	72
3770	63	63	63	63	63	63	63	63	63	63
3780	55	55	55	55	55	55	55	55	55	55
3790	48	48	48	48	48	48	48	48	48	48
3800	41	41	41	41	41	41	41	41	41	41
3810	34	34	34	34	34	34	34	34	34	34
3820	27	27	27	27	27	27	27	27	27	27
3830	20	20	20	20	20	20	20	20	20	20
3840	13	13	13	13	13	13	13	13	13	13
3850	6	6	6	6	6	6	6	6	6	6
3860	-1	-1	-1	-1	-1	-1	-1	-1	-1	-1
3870	-8	-8	-8	-8	-8	-8	-8	-8	-8	-8
3880	-15	-15	-15	-15	-15	-15	-15	-15	-15	-15
3890	-22	-22	-22	-22	-22	-22	-22	-22	-22	-22
3900	-29	-29	-29	-29	-29	-29	-29	-29	-29	-29
3910	-36	-36	-36	-36	-36	-36	-36	-36	-36	-36
3920	-43	-43	-43	-43	-43	-43	-43	-43	-43	-43
3930	-50	-50	-50	-50	-50	-50	-50	-50	-50	-50
3940	-57	-57	-57	-57	-57	-57	-57	-57	-57	-57
3950	-64	-64	-64	-64	-64	-64	-64	-64	-64	-64
3960	-71	-71	-71	-71	-71	-71	-71	-71	-71	-71
3970	-78	-78	-78	-78	-78	-78	-78	-78	-78	-78
3980	-85	-85	-85	-85	-85	-85	-85	-85	-85	-85
3990	-92	-92	-92	-92	-92	-92	-92	-92	-92	-92
4000	-99	-99	-99	-99	-99	-99	-99	-99	-99	-99
4010	-106	-106	-106	-106	-106	-106	-106	-106	-106	-106
4020	-113	-113	-113	-113	-113	-113	-113	-113	-113	-113
4030	-120	-120	-120	-120	-120	-120	-120	-120	-120	-120
4040	-127	-127	-127	-127	-127	-127	-127	-127	-127	-127
4050	-134	-134	-134	-134	-134	-134	-134	-134	-134	-134
4060	-141	-141	-141	-141	-141	-141	-141	-141	-141	-141
4070	-148	-148	-148	-148	-148	-148	-148	-148	-148	-148
4080	-155	-155	-155	-155	-155	-155	-155	-155	-155	-155
4090	-162	-162	-162	-162	-162	-162	-162	-162	-162	-162
4100	-169	-169	-169	-169	-169	-169	-169	-169	-169	-169
4110	-176	-176	-176	-176	-176	-176	-176	-176	-176	-176
4120	-183	-183	-183	-183	-183	-183	-183	-183	-183	-183
4130	-190	-190	-190	-190	-190	-190	-190	-190	-190	-190
4140	-197	-197	-197	-197	-197	-197	-197	-197	-197	-197
4150	-204	-204	-204	-204	-204	-204	-204	-204	-204	-204
4160	-211	-211	-211	-211	-211	-211	-211	-211	-211	-211
4170	-218	-218	-218	-218	-218	-218	-218	-218	-218	-218
4180	-225	-225	-225	-225	-225	-225	-225	-225	-225	-225
4190	-232	-232	-232	-232	-232	-232	-232	-232	-232	-232
4200	-239	-239	-239	-239	-239	-239	-239	-239	-239	-239
4210	-246	-246	-246	-246	-246	-246	-246	-246	-246	-246
4220	-253	-253	-253	-253	-253	-253	-253	-253	-253	-253
4230	-260	-260	-260	-260	-260	-260	-260	-260	-260	-260
4240	-267	-267	-267	-267	-267	-267	-267	-267	-267	-267
4250	-274	-274	-274	-274	-274	-274	-274	-274	-274	-274
4260	-281	-281	-281	-281	-281	-281	-281	-281	-281	-281

TO BE CONTINUED

TO BE CONTINUED

CONTINUED (S-2112 W33N)										CONTINUED (S-2112 W33N)											
NO.	(1)	(2)	(3)	(4)	(5)	(6)	(7)	(8)	(9)	(10)	NO.	(1)	(2)	(3)	(4)	(5)	(6)	(7)	(8)	(9)	(10)
4270	75	72	67	63	57	50	42	34	24	12	4810	-23	-20	-17	-11	-4	0	3	11	17	22
4280	-1	-13	-23	-35	-47	-58	-69	-80	-91	-101	4820	27	31	33	38	41	45	46	46	46	46
4290	-110	-119	-127	-135	-142	-149	-155	-161	-167	-170	4830	46	47	50	53	56	58	62	64	65	67
4300	-172	-173	-171	-167	-160	-153	-143	-130	-115	-99	4840	70	71	69	67	66	64	62	62	61	59
4310	-83	-66	-50	-34	-20	-5	7	18	26	35	4850	56	54	52	51	49	46	45	41	38	36
4320	44	55	66	76	84	90	95	100	103	104	4860	34	30	28	26	26	26	30	33	35	35
4330	104	105	101	96	89	81	74	65	55	45	4870	37	40	41	42	42	41	40	38	36	34
4340	33	22	12	1	-10	-20	-29	-37	-43	-49	4880	31	29	27	26	25	25	25	25	24	24
4350	-55	-59	-44	-36	-25	-15	-5	5	15	26	4890	25	26	26	23	21	20	18	16	16	14
4360	-49	-44	-40	-36	-31	-27	-25	-23	-21	-18	4900	8	3	-1	-6	-11	-15	-19	-25	-30	-31
4370	-15	-12	-14	-14	-14	-14	-14	-14	-14	-14	4910	-34	-36	-39	-38	-39	-40	-40	-44	-44	-45
4380	-27	-32	-37	-43	-49	-54	-59	-63	-65	-68	4920	-49	-49	-49	-49	-49	-49	-48	-47	-43	-41
4390	-72	-74	-75	-75	-75	-75	-75	-75	-75	-75	4930	-40	-37	-32	-27	-23	-21	-17	-15	-12	-12
4400	-61	-54	-47	-38	-30	-20	-6	10	25	39	4940	-5	-2	1	2	4	6	9	11	11	12
4410	51	63	75	86	95	101	107	113	118	122	4950	13	14	16	18	20	19	17	18	14	20
4420	126	129	130	130	132	132	131	129	126	121	4960	20	20	20	20	16	13	8	4	1	-4
4430	113	105	97	87	75	63	49	36	25	14	4970	-10	-17	-24	-30	-36	-42	-49	-54	-58	-62
4440	2	-8	-19	-27	-35	-43	-50	-56	-63	-70	4980	-67	-72	-78	-85	-91	-97	-104	-111	-118	-124
4450	-76	-81	-85	-87	-90	-93	-92	-88	-84	-80	4990	-72	-66	-58	-54	-48	-39	-28	-20	-13	0
4460	-77	-72	-65	-60	-57	-55	-54	-54	-53	-51	5000	10	18	29	42	56	66	75	83	93	100
4470	-50	-49	-47	-45	-43	-42	-43	-43	-43	-43	5010	107	113	119	123	126	127	126	124	123	120
4480	12	21	28	33	39	43	47	52	57	59	5020	118	115	112	107	103	98	91	83	74	65
4490	62	66	71	73	76	78	79	79	80	81	5030	56	48	41	35	26	20	13	5	-1	-6
4500	81	79	75	72	69	65	61	56	50	44	5040	-10	-16	-22	-27	-32	-38	-41	-44	-47	-50
4510	38	33	30	25	20	17	15	13	12	10	5050	-52	-53	-54	-54	-55	-54	-52	-52	-51	-50
4520	8	4	0	5	-10	-14	-19	-22	-24	-25	5060	-69	-68	-64	-61	-60	-58	-56	-54	-52	-50
4530	-25	-24	-24	-21	-19	-16	-13	-9	-3	0	5070	-14	-10	-7	-5	-5	-5	-6	-7	-9	-11
4540	1	1	2	2	2	2	2	2	2	3	5080	-18	-22	-27	-33	-38	-42	-46	-52	-58	-64
4550	5	6	6	8	9	9	9	8	7	8	5090	-69	-74	-80	-86	-92	-96	-97	-98	-96	-93
4560	9	10	10	10	10	11	11	10	11	14	5100	-90	-87	-84	-79	-74	-70	-64	-57	-50	-45
4570	18	22	24	25	27	31	35	39	42	44	5110	-42	-37	-31	-27	-22	-19	-15	-13	-11	-10
4580	47	49	53	55	55	52	48	43	36	30	5120	-8	-6	-5	-5	-5	-4	-4	-3	-3	0
4590	64	61	59	55	52	48	43	36	30	25	5130	0	1	5	7	11	14	17	22	26	29
4600	20	12	5	0	-6	-16	-24	-33	-42	-50	5140	32	38	43	46	46	53	56	60	63	65
4610	-56	-63	-69	-74	-80	-84	-87	-88	-91	-92	5150	68	69	69	69	71	72	73	73	69	65
4620	-90	-88	-87	-85	-80	-78	-76	-74	-70	-66	5160	61	58	53	47	40	31	23	15	7	-2
4630	-62	-59	-55	-50	-46	-42	-37	-30	-23	-18	5170	-10	-17	-24	-31	-38	-42	-45	-49	-53	-56
4640	-11	-8	-5	-1	0	3	6	9	13	14	5180	-60	-65	-67	-68	-69	-70	-68	-68	-66	-65
4650	15	18	20	20	20	20	20	21	22	24	5190	-64	-61	-59	-56	-52	-48	-44	-38	-30	-20
4660	26	29	30	32	37	40	44	49	53	55	5200	-14	-7	0	7	12	14	18	21	24	28
4670	59	61	62	62	62	61	58	53	50	47	5210	31	34	38	44	47	49	51	53	55	57
4680	46	43	38	34	31	28	27	25	21	20	5220	18	14	11	8	5	3	0	0	0	0
4690	18	17	16	15	14	15	16	16	16	16	5230	18	14	11	8	5	3	0	0	0	0
4700	19	20	21	22	24	25	28	31	32	35	5240	-5	-9	-17	-21	-25	-29	-32	-35	-37	-37
4710	19	20	21	22	24	25	28	31	32	35	5250	-41	-44	-47	-50	-54	-58	-60	-62	-65	-68
4720	37	40	40	40	40	40	40	40	40	40	5260	-70	-74	-77	-79	-80	-82	-83	-82	-81	-81
4730	12	7	2	0	-2	-7	-12	-15	-18	-22	5270	-81	-79	-77	-73	-70	-65	-60	-55	-50	-44
4740	-27	-35	-39	-46	-52	-59	-67	-73	-79	-86	5280	-39	-34	-29	-24	-18	-10	-3	4	12	20
4750	-90	-92	-94	-95	-99	-99	-98	-98	-99	-99	5290	27	33	39	43	47	50	52	54	54	54
4760	-98	-97	-95	-93	-90	-86	-80	-74	-67	-59	5300	56	57	56	56	54	53	51	48	44	41
4770	-53	-47	-40	-39	-34	-29	-24	-22	-19	-17	5310	37	35	30	23	19	14	14	16	17	8
4780	-13	-10	-12	-10	-8	-8	-10	-12	-10	-13	5320	2	0	0	0	0	0	0	0	0	0
4790	-17	-19	-23	-25	-28	-29	-32	-35	-37	-39	5330	-10	-12	-13	-15	-15	-15	-16	-17	-15	-14
4800	-39	-39	-39	-39	-38	-34	-34	-33	-32	-29	5340	-18	-22	-24	-25	-27	-30	-32	-32	-32	-32

TO BE CONTINUED

TO BE CONTINUED

CONTINUED(S-2112 W33N)

NO.	(1)	(2)	(3)	(4)	(5)	(6)	(7)	(8)	(9)	(10)
5350	-32	-31	-30	-28	-25	-23	-21	-20	-19	-19
5360	-17	-15	-14	-10	-5	-3	-4	-2	0	4
5370	8	12	16	18	20	23	25	27	30	32
5380	33	35	35	34	35	36	37	37	37	37
5390	38	39	40	41	41	40	42	42	40	40
5400	37	35	30	26	22	17	12	8	3	-3
5410	-10	-14	-18	-22	-26	-29	-33	-38	-42	-46
5420	-50	-53	-55	-55	-55	-56	-56	-55	-58	-58
5430	-58	-60	-60	-60	-59	-57	-57	-56	-55	-52
5440	-45	-41	-39	-33	-25	-18	-11	-3	2	9
5450	15	19	26	32	39	44	49	56	62	67
5460	74	80	85	86	89	90	92	92	92	91
5470	89	87	84	81	76	72	65	59	51	43
5480	33	24	15	6	-2	-12	-22	-30	-38	-45
5490	-51	-58	-67	-75	-81	-88	-96	-104	-111	-117
5500	-120	-124	-128	-130	-130	-131	-132	-133	-131	-127
5510	-121	-114	-107	-101	-93	-84	-74	-62	-50	-38
5520	-26	-15	-1	14	31	45	57	70	83	97
5530	109	114	120	130	134	135	140	146	148	150
5540	151	151	150	148	143	138	133	124	118	109
5550	100	91	78	65	54	42	31	20	11	3
5560	-6	-14	-22	-30	-37	-43	-49	-55	-60	-64
5570	-67	-71	-74	-77	-79	-79	-79	-79	-76	-76
5580	-74	-72	-68	-65	-62	-58	-51	-46	-41	-35
5590	-28	-22	-15	-8	-4	3	11	17	22	24
5600	28	28	35	38	40	42	42	43	45	45
5610	45	45	43	42	38	36	35	33	31	27
5620	22	17	16	13	9	6	4	1	0	-2
5630	-6	-8	-12	-15	-18	-20	-21	-22	-22	-23
5640	-24	-25	-22	-19	-18	-16	-14	-10	-9	-6
5650	-4	0	3	5	11	16	19	21	23	26
5660	29	31	32	32	31	28	27	28	27	25
5670	22	21	20	17	14	13	11	6	2	0
5680	-5	-9	-12	-13	-18	-21	-23	-26	-27	-31
5690	-32	-32	-32	-32	-34	-38	-39	-41	-42	-43
5700	-43	-42	-42	-42	-40	-38	-33	-28	-25	-21
5710	-19	-15	-8	-1	10	15	21	28	35	42
5720	21	21	22	24	27	30	32	35	37	37
5730	37	37	40	44	42	41	40	41	40	36
5740	35	32	32	36	36	32	29	30	32	35
5750	37	39	42	44	44	46	49	50	51	55
5760	60	64	67	70	72	76	76	77	77	76
5770	74	70	67	64	60	56	52	46	42	36
5780	29	21	15	6	-2	-7	-15	-27	-35	-45
5790	-50	-58	-64	-69	-73	-77	-79	-80	-83	-84
5800	-84	-85	-84	-85	-87	-85	-84	-82	-78	-73
5810	-68	-64	-59	-56	-49	-43	-38	-32	-24	-18
5820	-14	-9	-2	2	5	7	10	16	20	19
5830	19	20	19	17	17	14	11	11	9	4
5840	-1	-7	-13	-16	-24	-28	-33	-39	-43	-45
5850	-49	-50	-50	-55	-59	-58	-57	-57	-55	-55
5860	-54	-51	-46	-42	-41	-37	-32	-26	-19	-12
5870	-5	3	13	19	27	34	42	48	54	58
5880	63	68	74	81	83	84	84	85	84	84

TO BE CONTINUED

CONTINUED(S-2112 W33N)

NO.	(1)	(2)	(3)	(4)	(5)	(6)	(7)	(8)	(9)	(10)
5890	84	81	80	79	73	66	59	51	45	37
5900	26	17	7	-3	-11	-18	-25	-31	-38	-45
5910	-51	-56	-61	-65	-68	-72	-76	-77	-74	-74
5920	-73	-72	-69	-66	-64	-64	-59	-54	-51	-46
5930	-41	-37	-33	-28	-21	-15	-7	0	5	12
5940	20	27	35	40	45	53	61	65	69	74
5950	78	81	83	85	84	83	81	81	80	79
5960	77	75	74	72	69	67	64	60	56	53
5970	47	41	36	29	23	19	15	11	7	2
5980	0	0	-5	-11	-15	-17	-20	-22	-26	-30
5990	-34	-39	-43	-45	-46	-50	-51	-53	-54	-54

END

RECORD = S-2112 COMPONENT = DOWN STATION = KEIRIN-JI-S
 DATE AND TIME = 1987-12-17-11-08 TOTAL NUMBER OF DATA = 6000
 SIGNAL = GR. ACC. SAMPLING INTERVAL = 0.010 (SEC) SCAL = 0.10000
 CONNECTION POINT IN DATA NUMBER = 3007, 6000,

CONTINUED(S-2112 DOWN)

NO.	(1)	(2)	(3)	(4)	(5)	(6)	(7)	(8)	(9)	(10)
0	-14	-17	-19	-22	-24	-27	-29	-31	-32	-34
10	-36	-37	-37	-37	0	9	13	15	18	16
20	-25	-21	-16	-8	0	9	13	15	18	16
30	14	11	6	1	-3	-7	-12	-17	-23	-28
40	-34	-36	-37	-35	-32	-27	-20	-11	1	13
50	26	35	41	43	42	38	32	22	9	-6
60	-21	-33	-39	-43	-41	-39	-38	-36	-34	-31
70	-29	-26	-23	-21	-19	-17	-18	-21	-25	-31
80	-26	-38	-39	-40	-41	-42	-40	-37	-32	-27
90	-24	-25	-29	-35	-42	-46	-47	-46	-44	-39
100	-33	-27	-22	-22	-24	-25	-25	-23	-19	-8
110	0	5	8	6	0	-7	-16	-26	-35	-34
120	-30	-22	-17	-15	-15	-18	-20	-17	-7	4
130	19	33	40	40	38	36	33	32	31	27
140	15	1	-10	-18	-23	-24	-25	-28	-33	-22
150	34	32	-26	-20	-16	-13	-15	-16	-18	-22
160	-25	-29	-31	-31	-32	-32	-30	-25	-22	-15
170	-10	-9	-8	-8	-8	-5	2	15	34	51
180	61	66	66	62	54	47	39	33	28	24
190	23	19	11	-5	-10	-14	-18	-20	-21	-14
200	-23	-29	-37	-46	-54	-62	-66	-66	-64	-63
210	-63	-64	-67	-74	-82	-83	-74	-59	-49	-46
220	-49	-56	-64	-66	-66	-66	-66	-66	-66	-66
230	21	22	21	18	16	16	15	15	16	15
240	13	9	6	7	9	9	8	2	-21	-44
250	-68	-85	-92	-89	-75	-57	-42	-34	-28	-25
260	-23	-21	-21	-24	-32	-38	-41	-40	-34	-26
270	-19	-13	-8	-4	0	6	12	16	19	21
280	21	24	26	26	25	24	26	25	21	15
290	5	-2	5	0	9	20	29	36	38	33
300	18	-6	-40	-74	-98	-110	-113	-111	-106	-100
310	-94	-90	-89	-89	-87	-85	-82	-80	-80	-81
320	-81	-78	-69	-56	-43	-30	-18	-8	-1	3
330	3	1	1	0	-2	-2	0	8	17	25
340	28	27	25	27	30	31	31	31	31	31
350	34	41	54	68	76	75	67	50	26	4
360	-12	-22	-26	-28	-28	-27	-25	-22	-21	-23
370	-25	-24	-18	-4	11	22	26	22	10	-2
380	-15	-24	-32	-39	-62	-44	-45	-48	-49	-58
390	-66	-73	-77	-81	-83	-82	-77	-68	-58	-50
400	-46	-42	-38	-32	-23	-13	0	15	32	46
410	54	53	47	40	36	33	34	35	38	41
420	68	55	53	63	63	59	40	14	18	18
430	-52	-61	-67	-68	-65	-57	-42	-26	-12	-2
440	4	8	10	5	-4	-14	-19	-20	-15	-12
450	-10	-8	-10	-15	-19	-22	-21	-19	-16	-14
460	-12	-15	-19	-23	-27	-32	-36	-34	-28	-19
470	-9	-1	4	7	4	-4	-17	-30	-40	-43
480	-39	-30	-17	-2	11	19	26	29	28	22

TO BE CONTINUED

CONTINUED(S-2112 DOWN)

CONTINUED(S-2112 DOWN)

NO.	(1)	(2)	(3)	(4)	(5)	(6)	(7)	(8)	(9)	(10)
1030	-1	8	17	32	25	30	37	39	39	39
1040	39	39	39	39	39	39	41	42	40	35
1050	25	14	4	-4	-10	-15	-18	-23	-33	-47
1060	-59	-68	-69	-70	-68	-65	-63	-61	-59	-56
1070	-47	-28	7	22	41	57	67	74	77	77
1080	79	79	78	73	65	56	45	31	15	0
1090	-14	-26	-35	-40	-44	-44	-41	-36	-29	-23
1100	-17	-11	-2	-4	-2	-1	-1	-2	0	6
1110	15	28	42	54	59	60	55	45	29	3
1120	-26	-35	-79	-98	-112	-124	-132	-136	-134	-127
1130	-113	-96	-81	-69	-60	-54	-50	-48	-50	-50
1140	-61	-69	-77	-83	-87	-91	-92	-93	-92	-90
1150	-86	-77	-56	-31	-5	15	32	44	54	63
1160	71	82	94	101	106	107	106	105	104	104
1170	102	99	89	68	43	17	-5	-22	-37	-53
1180	-69	-84	-96	-107	-114	-116	-115	-106	-92	-70
1190	-51	-41	-36	-36	-41	-46	-50	-50	-47	-42
1200	-35	-22	-3	17	38	52	61	64	63	58
1210	49	33	11	-11	-33	-50	-61	-66	-66	-62
1220	-56	-47	-37	-23	-7	6	16	19	14	4
1230	-11	-30	-41	-43	-43	-42	-40	-39	-37	-36
1240	-35	-33	-27	-22	-17	-12	-9	-10	-17	-27
1250	-41	-45	-46	-46	-46	-44	-41	-34	-16	17
1260	52	81	105	121	127	126	117	101	82	68
1270	58	54	54	58	63	68	71	71	65	51
1280	26	0	-19	-30	-36	-38	-38	-39	-43	-49
1290	-65	-61	-63	-65	-68	-72	-77	-83	-89	-94
1300	-99	-104	-110	-116	-119	-121	-120	-117	-112	-101
1310	-84	-66	-49	-30	-9	13	38	67	99	125
1320	140	149	154	155	155	148	142	133	127	120
1330	112	104	97	90	85	79	72	65	56	44
1340	31	3	-5	-10	-13	-15	-17	-19	-20	-20
1350	-21	-23	-26	-35	-47	-59	-68	-73	-74	-72
1360	-69	-64	-59	-55	-52	-45	-32	-11	21	52
1370	69	78	84	87	89	88	85	80	70	54
1380	32	8	-12	-26	-35	-43	-47	-45	-39	-32
1390	-26	-25	-26	-30	-35	-40	-42	-42	-37	-52
1400	-21	-14	-10	-9	-12	-21	-32	-43	-51	-52
1410	-69	-40	-34	-5	11	21	24	18	6	-6
1420	-16	-24	-43	-39	-34	-39	-43	-46	-47	-48
1430	-47	-47	-45	-42	-39	-32	-23	-13	-3	9
1440	19	27	34	39	43	44	43	40	35	30
1450	26	22	19	17	16	16	16	16	15	15
1460	19	24	32	43	60	74	84	91	93	90
1470	77	54	25	-3	-28	-54	-77	-91	-100	-104
1480	-102	-92	-73	-48	-17	21	65	98	123	136
1490	139	137	126	105	79	50	18	-16	-53	-84
1500	-100	-106	-106	-100	-87	-67	-47	-31	-18	-6
1510	1	7	13	18	22	25	29	34	40	50
1520	58	61	61	59	53	42	26	6	-20	-50
1530	-76	-97	-111	-118	-121	-119	-112	-103	-89	-69
1540	-44	-16	9	29	40	45	46	46	46	46
1550	47	46	47	48	46	43	41	35	26	17
1560	11	7	5	4	2	1	-1	-6	-11	-17

TO BE CONTINUED

TO BE CONTINUED

NO.	(1)	(2)	(3)	(4)	(5)	(6)	(7)	(8)	(9)	(10)
2110	39	14	-12	-42	-74	-104	-128	-147	-160	-168
2120	-172	-176	-180	-183	-185	-184	-177	-161	-142	-123
2130	-107	-95	-86	-78	-72	-65	-57	-48	-40	-32
2140	-66	-64	-62	-61	-60	-59	-58	-57	-56	-55
2150	8	12	17	24	32	42	54	68	81	91
2160	98	102	106	110	114	115	116	117	119	122
2170	127	133	140	144	147	147	144	135	120	98
2180	71	43	11	-23	-55	-81	-102	-120	-132	-140
2190	-147	-150	-148	-143	-135	-121	-103	-85	-69	-58
2200	-51	-49	-46	-44	-43	-42	-39	-33	-25	-15
2210	3	10	23	33	40	47	52	57	62	67
2220	70	75	80	85	89	89	88	85	80	73
2230	65	56	44	33	25	21	20	20	24	31
2240	36	40	42	42	42	40	36	33	27	19
2250	11	2	-8	-17	-23	-27	-30	-29	-28	-27
2260	-28	-29	-31	-35	-40	-48	-56	-62	-66	-68
2270	-67	-63	-54	-44	-33	-25	-15	-5	2	10
2280	18	26	33	39	44	48	50	50	48	46
2290	41	35	25	11	-5	-17	-24	-31	-38	-46
2300	-51	-54	-55	-54	-51	-44	-31	-9	-20	-50
2310	77	102	124	138	145	148	150	149	147	143
2320	136	139	132	114	104	92	80	68	58	48
2330	61	38	37	38	40	46	52	56	60	64
2340	65	64	61	54	45	34	18	0	-16	-33
2350	-55	-75	-96	-113	-126	-137	-145	-151	-152	-151
2360	-148	-144	-137	-131	-124	-116	-104	-88	-68	-47
2370	-27	-10	28	45	60	75	87	97	106	116
2380	114	123	130	134	136	138	138	136	134	134
2390	132	139	128	129	133	140	146	149	149	149
2400	117	112	134	122	106	87	65	46	28	9
2410	-11	-34	-53	-66	-76	-84	-89	-93	-96	-95
2420	-94	-91	-86	-78	-68	-54	-40	-29	-20	-14
2430	-9	-6	-2	0	2	4	4	1	-1	-6
2440	-14	-25	-35	-44	-49	-49	-47	-43	-36	-24
2450	-8	8	25	44	62	76	87	93	97	99
2460	99	97	91	83	73	62	49	34	21	10
2470	0	-13	-26	-39	-51	-60	-68	-74	-77	-78
2480	-76	-72	-67	-60	-54	-49	-45	-41	-38	-35
2490	-31	-28	-25	-24	-24	-26	-29	-33	-38	-47
2500	-53	-58	-61	-63	-62	-57	-50	-44	-38	-31
2510	-21	-11	0	12	28	44	60	78	96	109
2520	120	139	137	142	144	144	142	136	128	115
2530	101	88	75	60	46	36	27	19	10	2
2540	5	-10	-14	-18	-18	-16	-13	-7	-4	-3
2550	-4	-5	-5	-6	-9	-13	-16	-19	-21	-22
2560	-23	-23	-21	-15	-5	6	20	32	41	50
2570	56	60	62	63	63	60	59	58	57	57
2580	57	57	58	60	62	63	64	64	58	49
2590	38	25	-7	-21	-32	-39	-42	-43	-42	-42
2600	-41	-40	-38	-38	-38	-40	-39	-38	-37	-34
2610	-30	-26	-23	-21	-16	-11	-8	-5	-3	0
2620	4	7	10	11	12	10	8	5	3	0
2630	7	9	10	10	11	14	16	20	25	33
2640	40	48	60	72	77	80	81	79	78	77
2650	48	48	60	72	77	80	81	79	78	77
2660	48	48	60	72	77	80	81	79	78	77
2670	48	48	60	72	77	80	81	79	78	77
2680	48	48	60	72	77	80	81	79	78	77
2690	48	48	60	72	77	80	81	79	78	77
2700	48	48	60	72	77	80	81	79	78	77
2710	48	48	60	72	77	80	81	79	78	77
2720	48	48	60	72	77	80	81	79	78	77
2730	48	48	60	72	77	80	81	79	78	77
2740	48	48	60	72	77	80	81	79	78	77
2750	48	48	60	72	77	80	81	79	78	77
2760	48	48	60	72	77	80	81	79	78	77
2770	48	48	60	72	77	80	81	79	78	77
2780	48	48	60	72	77	80	81	79	78	77
2790	48	48	60	72	77	80	81	79	78	77
2800	48	48	60	72	77	80	81	79	78	77
2810	48	48	60	72	77	80	81	79	78	77
2820	48	48	60	72	77	80	81	79	78	77
2830	48	48	60	72	77	80	81	79	78	77
2840	48	48	60	72	77	80	81	79	78	77
2850	48	48	60	72	77	80	81	79	78	77
2860	48	48	60	72	77	80	81	79	78	77
2870	48	48	60	72	77	80	81	79	78	77
2880	48	48	60	72	77	80	81	79	78	77
2890	48	48	60	72	77	80	81	79	78	77
2900	48	48	60	72	77	80	81	79	78	77
2910	48	48	60	72	77	80	81	79	78	77
2920	48	48	60	72	77	80	81	79	78	77
2930	48	48	60	72	77	80	81	79	78	77
2940	48	48	60	72	77	80	81	79	78	77
2950	48	48	60	72	77	80	81	79	78	77
2960	48	48	60	72	77	80	81	79	78	77
2970	48	48	60	72	77	80	81	79	78	77
2980	48	48	60	72	77	80	81	79	78	77
2990	48	48	60	72	77	80	81	79	78	77
3000	48	48	60	72	77	80	81	79	78	77
3010	48	48	60	72	77	80	81	79	78	77
3020	48	48	60	72	77	80	81	79	78	77
3030	48	48	60	72	77	80	81	79	78	77
3040	48	48	60	72	77	80	81	79	78	77
3050	48	48	60	72	77	80	81	79	78	77
3060	48	48	60	72	77	80	81	79	78	77
3070	48	48	60	72	77	80	81	79	78	77
3080	48	48	60	72	77	80	81	79	78	77
3090	48	48	60	72	77	80	81	79	78	77
3100	48	48	60	72	77	80	81	79	78	77
3110	48	48	60	72	77	80	81	79	78	77
3120	48	48	60	72	77	80	81	79	78	77
3130	48	48	60	72	77	80	81	79	78	77
3140	48	48	60	72	77	80	81	79	78	77
3150	48	48	60	72	77	80	81	79	78	77
3160	48	48	60	72	77	80	81	79	78	77
3170	48	48	60	72	77	80	81	79	78	77
3180	48	48	60	72	77	80	81	79	78	77

TO BE CONTINUED

TO BE CONTINUED

CONTINUED(S-2112 DOWN)

CONTINUED(S-2112 DOWN)

NO.	(1)	(2)	(3)	(4)	(5)	(6)	(7)	(8)	(9)	(10)
3190	36	33	28	21	15	8	3	1	-1	-5
3200	-8	-15	-6	-3	-1	0	1	2	3	7
3210	11	18	20	25	31	37	42	45	48	49
3220	31	52	51	50	48	46	42	37	30	22
3230	13	4	-6	-17	-27	-36	-44	-52	-57	-61
3240	-85	-68	-70	-71	-73	-75	-75	-74	-72	-72
3250	-68	-63	-56	-50	-45	-35	-28	-21	-14	-8
3260	-3	-1	0	0	-1	-3	-7	-11	-12	-11
3270	-8	-5	-1	1	4	7	11	16	22	27
3280	32	37	42	46	48	48	45	42	39	34
3290	26	17	8	0	-8	-18	-27	-36	-44	-49
3300	-54	-57	-60	-61	-61	-60	-59	-58	-55	-52
3310	-50	-48	-46	-45	-43	-40	-38	-39	-39	-38
3320	-36	-36	-35	-32	-28	-25	-23	-21	-17	-11
3330	-3	3	10	17	23	28	32	37	42	44
3340	46	50	55	60	65	69	72	74	75	76
3350	77	76	76	75	74	74	74	73	71	68
3360	65	62	56	50	44	37	30	20	11	4
3370	-1	-9	-19	-28	-36	-42	-48	-53	-56	-57
3380	-55	-54	-51	-48	-44	-41	-35	-28	-20	-12
3390	-2	9	20	31	40	49	56	64	70	72
3400	72	70	67	63	57	48	38	30	23	17
3410	10	5	2	0	-1	-2	-3	-3	-1	2
3420	7	14	23	32	40	47	53	57	58	58
3430	56	53	47	41	36	29	21	11	4	-2
3440	-10	-16	-21	-24	-27	-29	-30	-30	-29	-28
3450	-27	-26	-27	-29	-30	-32	-37	-43	-49	-55
3460	-61	-66	-70	-70	-70	-72	-72	-72	-72	-72
3470	-70	-67	-69	-70	-69	-66	-63	-59	-54	-48
3480	-43	-37	-30	-22	-15	-8	0	6	12	19
3490	25	30	35	40	43	48	53	57	60	65
3500	69	73	78	81	82	83	82	80	77	73
3510	68	63	60	58	58	57	56	55	53	50
3520	46	43	39	36	33	30	27	22	19	14
3530	10	7	5	3	2	1	1	1	1	1
3540	0	0	-1	0	0	0	0	-1	-1	0
3550	1	4	6	6	6	6	6	6	6	6
3560	3	1	-1	-6	-10	-13	-15	-17	-19	-19
3570	-18	-17	-14	-13	-12	-9	-8	-5	-3	0
3580	4	6	9	15	18	22	27	32	38	45
3590	50	55	59	61	65	67	68	69	70	71
3600	70	70	70	69	68	65	63	59	53	45
3610	36	28	19	11	5	-1	-6	-10	-13	-13
3620	-12	-10	-8	-5	-3	-2	-1	0	-1	-2
3630	-2	-2	-2	-6	-7	-9	-11	-10	-10	-9
3640	-7	-4	-2	1	4	6	10	16	21	24
3650	27	28	28	28	27	24	20	18	17	13
3660	9	5	3	2	1	0	0	-1	0	1
3670	2	2	3	3	2	1	0	0	0	-1
3680	0	2	5	6	7	8	10	12	12	13
3690	15	16	17	16	16	17	17	13	9	6
3700	3	1	0	-2	-5	-8	-11	-13	-13	-12
3710	-13	-14	-12	-8	-4	-2	-1	0	-1	-2
3720	-2	-6	-11	-16	-21	-29	-33	-37	-42	-46
3730	3730	-47	-48	-47	-43	-41	-36	-29	-23	-17
3740	-12	-6	-2	1	5	7	9	12	13	13
3750	12	12	9	7	6	6	6	6	6	9
3760	13	17	21	24	31	37	42	47	53	61
3770	3770	67	73	79	82	82	79	77	73	71
3780	68	65	56	48	42	37	31	26	20	11
3790	5	-1	-1	-14	-21	-24	-28	-33	-37	-42
3800	-25	-21	-18	-16	-12	-6	0	7	15	24
3810	33	44	44	47	48	49	51	49	49	51
3820	49	46	44	43	44	43	43	43	43	43
3830	35	34	36	35	36	37	37	37	37	37
3840	36	32	27	21	14	6	1	-4	-9	-12
3850	-14	-17	-17	-18	-21	-22	-23	-23	-22	-23
3860	-22	-22	-19	-18	-18	-17	-15	-15	-13	-11
3870	-7	-5	-3	-2	-1	0	1	2	3	5
3880	7	8	10	12	12	12	12	12	11	11
3890	11	8	6	5	2	0	-4	-9	-12	-15
3900	-19	-22	-24	-27	-30	-33	-35	-39	-44	-47
3910	-50	-54	-56	-57	-58	-58	-57	-56	-53	-49
3920	-45	-42	-39	-33	-27	-22	-19	-16	-15	-15
3930	-16	-17	-18	-18	-20	-23	-24	-27	-28	-29
3940	-29	-26	-25	-24	-21	-20	-19	-17	-15	-14
3950	-12	-12	-12	-11	-10	-8	-5	-4	-3	-2
3960	-2	-2	-2	-3	-5	-7	-7	-9	-11	-11
3970	-11	-10	-9	-6	-4	1	7	13	17	23
3980	29	35	39	41	44	45	47	46	42	38
3990	33	28	22	14	7	0	-6	-11	-15	-18
4000	-19	-21	-24	-25	-24	-23	-24	-26	-25	-25
4010	-24	-21	-20	-20	-19	-17	-15	-12	-8	-5
4020	-3	0	4	8	12	16	20	23	25	28
4030	30	33	36	38	39	39	39	39	39	35
4040	31	25	18	11	5	0	-6	-11	-16	-20
4050	-24	-25	-28	-29	-30	-30	-29	-26	-22	-17
4060	-12	-5	0	5	10	15	18	22	25	26
4070	27	26	26	25	23	20	19	17	17	17
4080	15	14	12	11	12	13	14	14	16	18
4090	45	46	46	45	44	42	39	37	41	44
4100	14	8	0	-9	-21	-30	-37	-44	-50	-54
4120	-55	-56	-56	-55	-53	-50	-46	-42	-37	-31
4130	-24	-18	-13	-11	-10	-8	-6	-6	-7	-7
4140	-8	-10	-12	-14	-15	-17	-17	-16	-15	-15
4150	-13	-9	-4	-4	-5	-10	-15	-20	-24	-27
4160	30	32	33	33	32	30	25	21	16	9
4170	-46	-44	-45	-43	-41	-38	-37	-35	-31	-28
4180	-18	-14	-10	-6	-3	2	2	-2	-3	-5
4190	-11	-16	-21	-27	-32	-37	-40	-43	-44	-42
4200	-38	-31	-23	-17	-11	-5	0	6	10	15
4210	15	16	17	19	20	21	23	23	22	22
4220	22	21	21	21	21	19	18	16	14	12
4230	9	7	6	4	2	0	-2	-5	-8	-11
4250	-11	-11	-10	-10	-10	-10	-10	-10	-10	-10
4260	-3	-2	-3	-5	-6	-6	-6	-6	-6	-6

TO BE CONTINUED

TO BE CONTINUED

CONTINUED(S-2112 DOWN)

CONTINUED(S-2112 DOWN)

NO.	(1)	(2)	(3)	(4)	(5)	(6)	(7)	(8)	(9)	(10)
4270	-7	-6	-5	-3	-2	-1	0	0	1	1
4280	1	0	-1	-2	-3	-3	-2	-3	-6	-8
4290	-10	-12	-13	-13	-12	-13	-13	-13	-11	-8
4300	-6	-3	0	3	2	1	1	1	1	2
4310	24	25	25	24	23	21	18	15	13	12
4320	12	12	12	14	14	14	16	20	22	24
4330	27	29	30	31	31	31	34	36	37	39
4340	41	43	46	47	47	47	46	43	41	41
4350	38	34	31	27	22	16	9	1	-10	-22
4360	-31	-42	-51	-59	-65	-70	-75	-74	-73	-73
4370	-71	-68	-64	-59	-54	-48	-42	-36	-32	-28
4380	-22	-17	-13	-9	-5	-2	0	1	1	2
4390	4	6	8	10	11	13	15	17	21	23
4400	22	21	21	21	22	23	22	21	22	21
4410	19	13	7	4	0	-3	-7	-10	-13	-15
4420	-18	-18	-18	-18	-17	-16	-14	-12	-10	-9
4430	-7	-7	-5	-4	-2	-2	0	2	4	5
4440	7	9	12	14	17	20	21	22	20	19
4450	18	16	14	14	14	14	15	16	18	19
4460	20	21	22	24	24	24	24	23	21	18
4470	15	14	14	14	14	14	13	11	8	4
4480	0	-3	-7	-10	-15	-19	-22	-26	-29	-30
4490	-29	-23	-21	-18	-16	-11	-7	-3	1	8
4500	15	22	28	30	32	33	33	32	31	30
4510	25	19	15	11	8	5	2	-1	-2	-4
4520	5	-8	-11	-11	-13	-15	-14	-14	-15	-15
4530	-17	-20	-21	-24	-28	-31	-31	-34	-36	-37
4540	-39	-40	-41	-39	-38	-35	-32	-29	-25	-21
4550	-16	-9	-4	0	3	8	13	16	20	23
4560	24	29	34	37	40	41	42	42	43	44
4570	46	48	47	46	46	45	44	41	39	35
4580	31	29	28	25	18	11	6	-2	-7	-12
4590	-17	-23	-29	-32	-35	-37	-40	-42	-43	-42
4600	-42	-42	-45	-42	-42	-42	-43	-42	-40	-39
4610	-38	-36	-33	-32	-32	-32	-31	-32	-33	-34
4620	-32	-32	-33	-35	-36	-34	-32	-30	-28	-28
4630	-25	-21	-15	-12	-9	-4	0	4	9	13
4640	17	21	24	28	31	33	35	37	40	46
4650	50	54	57	61	66	73	77	80	83	85
4660	86	88	85	83	80	78	72	68	64	59
4670	54	49	45	39	35	32	28	25	23	8
4680	5	0	-5	-10	-14	-16	-21	-25	-29	-31
4690	-4	-37	-41	-41	-43	-43	-43	-42	-40	-38
4700	-39	-38	-33	-29	-27	-23	-19	-17	-16	-13
4710	-9	-6	-4	-2	0	1	2	1	1	3
4720	6	6	6	6	6	6	8	11	13	12
4730	12	13	13	13	13	12	12	12	9	8
4740	8	7	6	4	4	2	0	-1	-1	-2
4750	-5	-7	-10	-12	-13	-16	-20	-23	-25	-25
4760	-25	-26	-25	-26	-27	-26	-26	-26	-26	-26
4770	-25	-22	-18	-17	-15	-11	-8	-6	-6	-6
4780	2	2	4	6	7	8	9	13	17	21
4790	23	24	26	24	27	29	31	31	31	31
4800										

TO BE CONTINUED

TO BE CONTINUED

CONTINUER (S-2112 DOWN)

NO.	(1)	(2)	(3)	(4)	(5)	(6)	(7)	(8)	(9)	(10)
5350	34	37	41	44	45	45	46	46	46	46
5360	45	44	44	43	41	40	37	35	34	35
5370	35	32	27	24	21	15	13	10	6	3
5380	1	-2	-6	-9	-12	-17	-23	-29	-34	-36
5390	-38	-40	-44	-46	-46	-47	-47	-46	-47	-47
5400	-45	-43	-44	-44	-41	-39	-37	-35	-32	-30
5410	-28	-26	-24	-21	-18	-13	-9	-7	-4	1
5420	6	9	12	16	21	24	24	24	26	26
5430	28	31	32	32	33	34	34	35	36	35
5440	34	34	34	34	34	34	33	32	30	29
5450	29	27	25	24	22	20	17	14	12	13
5460	12	11	11	12	14	16	19	19	20	23
5470	25	26	26	28	31	34	38	40	41	43
5480	45	46	47	47	46	46	47	47	47	45
5490	44	44	42	40	37	35	31	26	22	18
5500	12	8	5	0	-5	-9	-14	-19	-23	-26
5510	-29	-31	-32	-34	-36	-37	-36	-35	-32	-30
5520	-29	-28	-25	-24	-22	-22	-22	-20	-17	-13
5530	-13	-12	-12	-11	-9	-6	-3	0	1	3
5540	5	7	10	11	12	13	14	14	14	14
5550	14	13	10	9	8	5	2	0	0	-2
5560	-4	-5	-6	-8	-10	-10	-11	-12	-14	-15
5570	-17	-20	-21	-21	-19	-19	-19	-15	-12	-9
5580	-8	-4	0	1	5	6	6	9	11	13
5590	15	18	18	19	18	18	18	15	14	13
5600	11	8	5	4	3	2	2	2	4	4
5610	0	-3	-4	-5	-5	-6	-9	-9	-9	-10
5620	-11	-12	-14	-15	-16	-20	-22	-23	-25	-24
5630	-23	-23	-24	-23	-20	-19	-17	-13	-9	-5
5640	-3	1	6	9	13	20	25	27	28	30
5650	35	36	37	37	38	40	41	39	38	35
5660	33	30	27	23	19	19	17	13	9	7
5670	8	8	6	6	8	10	11	12	9	9
5680	9	7	6	7	6	6	6	6	6	6
5690	6	6	6	7	6	6	6	6	6	6
5700	-10	-10	-9	-8	-4	-3	-4	-4	-2	-1
5710	0	-1	0	-1	0	1	2	0	-2	-2
5720	0	2	0	-1	0	0	0	0	2	3
5730	4	6	7	9	11	13	13	13	18	21
5740	19	19	19	21	19	18	18	16	14	13
5750	9	6	2	-1	-5	-8	-10	-13	-16	-18
5760	-20	-21	-21	-22	-21	-20	-18	-17	-16	-15
5770	-13	-11	-8	-10	-8	-6	-3	-2	-2	-2
5780	0	1	2	3	4	6	6	6	6	7
5790	6	6	6	6	9	12	14	16	17	18
5800	16	14	13	12	13	12	8	5	2	2
5810	3	-1	-7	-9	-12	-14	-16	-19	-22	-24
5820	-28	-35	-41	-43	-45	-48	-50	-50	-50	-52
5830	-53	-54	-56	-57	-57	-56	-55	-49	-44	-44
5840	-41	-37	-35	-30	-24	-19	-13	-7	0	5
5850	10	15	23	27	33	38	42	43	47	49
5860	52	54	53	54	53	52	51	51	52	51
5870	47	46	42	40	39	38	36	32	30	27
5880	26	25	22	21	20	18	15	11	7	6

TO BE CONTINUED

CONTINUER (S-2112 DOWN)

NO.	(1)	(2)	(3)	(4)	(5)	(6)	(7)	(8)	(9)	(10)
5890	5	1	-3	-6	-7	-10	-13	-16	-17	-17
5900	-18	-16	-14	-12	-11	-9	-5	0	4	6
5910	8	10	11	11	12	16	19	21	20	19
5920	21	22	21	21	22	22	22	24	24	25
5930	26	26	26	26	25	23	21	17	15	12
5940	10	6	6	5	1	0	-4	-7	-9	-11
5950	-15	-17	-20	-22	-24	-26	-28	-28	-29	-30
5960	-28	-26	-26	-28	-29	-30	-28	-26	-24	-24
5970	-22	-21	-21	-20	-17	-13	-11	-10	-9	-7
5980	-3	-1	-2	-2	-1	-1	-1	0	0	-1
5990	-2	0	0	-1	0	1	2	2	4	5

END

RECORD = S-2113 COMPONENT = N33E STATION = YAHASHITA-HEN-S
 DATE AND TIME = 1987-12-17-11-08 TOTAL NUMBER OF DATA = 6000
 SAMPLING INTERVAL = 0.010 (SEC) SCAL = 0.10000
 SIGNAL = GR. ACC.
 CORRECTION POINT IN DATA NUMBER = 2935, 6000, 6000.

CONTINUED(S-2113 N33E)
 NO. (1) (2) (3) (4) (5) (6) (7) (8) (9) (10)

NO.	(1)	(2)	(3)	(4)	(5)	(6)	(7)	(8)	(9)	(10)
0	6	6	6	6	5	5	5	5	5	5
10	5	5	5	5	5	5	5	5	5	5
20	5	5	4	3	2	2	2	1	1	1
30	1	1	1	2	2	2	3	4	5	6
40	6	8	10	10	11	11	10	9	8	7
50	5	4	4	2	0	-1	-3	-4	-6	-6
60	-7	-7	-7	-7	-6	-5	-3	-3	-3	-2
70	-1	0	1	1	0	1	1	1	1	2
80	2	2	2	0	-2	-3	-3	-3	-5	-6
90	-7	-8	-8	-8	-8	-7	-4	-2	1	4
100	5	6	6	5	5	4	1	0	-2	-6
110	-10	-12	-13	-14	-14	-14	-14	-13	-12	-14
120	-6	-3	0	3	7	11	14	17	17	19
130	16	13	9	4	-1	-6	-10	-13	-16	-19
140	-22	-24	-26	-26	-23	-17	-10	-3	3	8
150	14	21	30	33	32	31	30	25	17	8
160	0	-8	-16	-24	-30	-33	-34	-34	-33	-30
170	-26	-24	-20	-16	-9	-1	4	13	20	24
180	27	29	30	29	26	19	12	5	-1	-10
190	-22	-26	-29	-30	-31	-31	-30	-29	-27	-27
200	-23	-17	-9	-1	5	14	27	35	42	47
210	50	51	51	47	35	22	9	-1	-11	-21
220	-31	-40	-48	-53	-57	-60	-60	-59	-54	-42
230	-23	-4	20	43	63	75	80	82	76	63
240	43	23	0	-22	-42	-59	-70	-74	-77	-78
250	-74	-65	-49	-22	3	29	54	78	96	106
260	109	105	94	77	52	16	-21	-60	-91	-107
270	-114	-116	-112	-100	-79	-50	-21	-51	-56	-50
280	75	87	92	93	91	83	66	43	14	-21
290	-55	-84	-106	-120	-126	-128	-124	-110	-89	-60
300	-22	18	55	86	106	117	123	122	115	102
310	82	53	23	-3	-28	-47	-62	-72	-79	-81
320	-81	-76	-68	-57	-47	-37	-26	-17	-7	1
330	7	12	19	24	28	29	26	25	26	29
340	32	33	35	34	32	27	20	10	1	-7
350	-17	-30	-37	-42	-45	-45	-44	-42	-36	-30
360	-22	-14	2	8	19	29	37	42	47	49
370	46	41	32	20	6	-10	-26	-45	-62	-73
380	-78	-80	-80	-74	-64	-46	-24	-4	10	25
390	37	47	56	60	62	60	56	51	45	40
400	35	31	26	19	8	-1	-11	-24	-36	-45
410	-54	-64	-72	-77	-77	-72	-65	-55	-41	-25
420	-10	7	24	38	54	69	78	87	92	91
430	87	77	57	32	9	-11	-33	-54	-68	-77
440	-84	-86	-86	-82	-75	-66	-58	-51	-44	-36
450	-29	-22	-16	-11	-8	-5	-3	0	1	4
460	5	8	6	7	9	12	14	14	14	13
470	11	5	5	6	1	-3	-3	-2	-2	-1
480	1	3	5	5	5	5	4	2	-2	-6

TO BE CONTINUED

TO BE CONTINUED

CONTINUED (S-2113 N33E)

CONTINUED (S-2113 N33E)

	(1)	(2)	(3)	(4)	(5)	(6)	(7)	(8)	(9)	(10)
1030	-176	-175	-167	-153	-138	-92	-54	-4	51	92
1040	126	165	193	217	234	240	240	238	231	220
1050	210	198	188	183	180	179	180	182	185	185
1060	183	177	160	136	102	60	16	-31	-82	-137
1070	-183	-210	-238	-264	-287	-310	-327	-341	-347	-349
1080	-344	-328	-292	-234	-173	-105	-25	55	122	181
1090	218	240	248	245	230	202	160	103	35	45
1100	127	-185	-241	-304	-341	-362	-372	-374	-367	-348
1110	-320	-289	-275	-220	-194	-169	-143	-118	-93	-64
1120	-27	17	73	139	208	273	331	376	403	416
1130	415	396	361	299	197	56	-108	-260	-386	-482
1140	-579	-653	-688	-700	-699	-682	-648	-594	-523	-432
1150	324	302	-69	77	226	382	497	601	711	803
1160	851	875	885	868	837	789	582	438	293	88
1170	-154	-411	-390	-709	-779	-888	-817	-814	-795	-760
1180	-712	-652	-577	-492	-402	-316	-233	-149	-63	-1
1190	39	68	89	103	115	134	162	191	213	240
1200	271	298	319	335	351	361	364	364	356	338
1210	320	300	280	258	229	191	141	72	-14	-108
1220	-215	-322	-395	-447	-477	-488	-495	-467	-433	-379
1230	-307	-231	-141	52	24	105	170	218	251	273
1240	286	292	294	294	287	272	242	198	145	89
1250	43	14	8	24	55	95	129	144	149	146
1260	135	116	95	77	66	58	52	51	55	63
1270	74	86	94	99	99	90	73	50	24	0
1280	-24	-49	-65	-74	-81	-85	-85	-85	-85	-85
1290	-86	-87	-85	-76	-60	-34	0	27	43	51
1300	54	51	42	30	20	11	5	1	-3	-8
1310	-14	-23	-35	-51	-66	-82	-95	-105	-112	-118
1320	-123	-125	-126	-129	-131	-134	-136	-139	-140	-142
1330	-143	-140	-135	-129	-115	-87	-45	10	63	113
1340	161	202	232	271	310	332	346	358	362	359
1350	345	311	250	175	95	-16	-164	-286	-360	-393
1360	-414	-428	-422	-400	-360	-300	-201	-151	-51	-35
1370	116	164	190	199	194	170	128	71	11	-54
1380	-108	-145	-165	-174	-177	-176	-170	-161	-153	-148
1390	-143	-136	-126	-112	-98	-81	-63	-44	-15	24
1400	74	132	195	258	307	342	361	366	363	355
1410	343	332	317	297	270	237	195	146	91	27
1420	-34	-86	-125	-155	-179	-197	-211	-221	-227	-226
1430	-314	-188	-140	-64	23	99	160	220	275	308
1440	317	310	286	242	194	145	86	17	-49	-109
1450	-168	-222	-276	-333	-380	-414	-429	-424	-401	-359
1460	-288	-206	-124	-36	49	112	146	161	166	162
1470	151	137	117	97	80	65	55	51	49	52
1480	85	59	64	68	72	76	80	86	88	90
1490	85	74	55	30	1	-32	-58	-79	-95	-105
1500	-109	-109	-107	-95	-73	-44	-14	5	16	21
1510	20	8	-8	-21	-31	-33	-34	-32	-26	-18
1520	-10	-4	0	4	6	9	12	16	24	38
1530	53	67	79	91	105	115	123	130	139	149
1540	156	161	162	160	153	144	133	120	107	95
1550	82	70	58	49	41	34	28	22	14	5
1560	-1	-12	-31	-58	-94	-127	-155	-178	-194	-205

TO BE CONTINUED

TO BE CONTINUED

NO.	(1)	(2)	(3)	(4)	(5)	(6)	(7)	(8)	(9)	(10)
2110	33	13	-4	-18	-29	-35	-36	-33	-22	-6
2120	15	43	73	100	123	137	143	145	145	136
2130	123	106	84	57	26	-2	-30	-56	-69	-100
2140	-115	-124	-129	-130	-130	-127	-122	-112	-99	-86
2150	-74	-62	-50	-40	-33	-28	-27	-28	-34	-48
2160	-65	-83	-99	-114	-125	-129	-125	-111	-88	-57
2170	-28	-3	24	46	56	59	60	55	43	31
2180	18	6	-5	-19	-31	-42	-51	-57	-61	-62
2190	-56	-46	-32	-14	-1	12	22	30	37	41
2200	43	48	54	62	74	87	97	103	106	102
2210	90	75	54	23	-4	-28	-48	-63	-72	-74
2220	-74	-69	-60	-46	-34	-28	-23	-25	-36	-53
2230	-68	-84	-94	-100	-103	-104	-103	-101	-100	-100
2240	-99	-97	-94	-88	-81	-72	-62	-50	-37	-24
2250	-13	-5	-1	-1	-3	-7	-16	-28	-37	-42
2260	-44	-43	-39	-35	-30	-25	-20	-15	-9	0
2270	9	19	27	36	43	46	51	58	66	76
2280	85	93	107	121	131	138	143	147	148	144
2290	124	121	103	82	60	38	15	-3	-19	-33
2300	-45	-54	-59	-63	-67	-69	-69	-68	-65	-59
2310	-48	-36	-24	-9	6	23	43	62	79	97
2320	115	136	152	166	177	185	189	189	182	168
2330	149	126	103	85	71	61	51	43	39	35
2340	30	23	12	-1	-20	-39	-57	-73	-87	-100
2350	-109	-114	-118	-120	-122	-124	-129	-133	-134	-137
2360	-139	-140	-140	-137	-132	-120	-104	-85	-67	-50
2370	-34	-17	-7	-2	2	5	6	7	5	5
2380	5	5	6	8	12	17	22	30	38	43
2390	47	52	55	56	55	55	57	63	70	78
2400	86	95	104	110	115	115	113	109	104	98
2410	88	78	68	59	52	47	43	38	33	24
2420	9	-10	-34	-60	-92	-126	-156	-184	-203	-213
2430	-17	-215	-204	-183	-149	-102	-50	-5	33	67
2440	93	112	124	131	136	139	140	140	138	133
2450	125	111	93	77	59	33	11	-5	-22	-40
2460	-56	-72	-88	-99	-111	-121	-128	-131	-132	-129
2470	-123	-113	-99	-81	-62	-44	-22	-3	12	28
2480	40	48	54	59	65	72	77	83	91	97
2490	107	118	128	139	149	156	159	159	158	154
2500	145	133	116	87	50	15	-16	-55	-96	-134
2510	-165	-191	-209	-231	-234	-234	-226	-214	-200	-200
2520	-185	-172	-140	-155	-151	-150	-148	-145	-144	-143
2530	-142	-137	-132	-132	-128	-87	-63	-34	1	45
2540	92	128	153	174	191	201	204	203	197	188
2550	178	165	148	126	103	83	68	59	53	50
2560	50	55	60	68	78	85	90	92	93	94
2570	92	87	82	75	69	64	60	55	49	43
2580	35	27	18	8	2	-4	-14	-24	-33	-39
2590	-45	-50	-55	-58	-63	-69	-79	-90	-109	-131
2600	-153	-171	-183	-189	-190	-186	-179	-162	-136	-108
2610	-76	-44	-22	-6	9	24	33	40	44	48
2620	53	59	64	74	84	98	116	128	139	151
2630	165	171	177	182	185	184	180	171	162	148
2640	128	103	81	61	44	28	20	13	10	7

TO BE CONTINUED

TO BE CONTINUED

CONTINUED(S-2113 N33E)

CONTINUED(S-2113 N33E)

NO.	(1)	(2)	(3)	(4)	(5)	(6)	(7)	(8)	(9)	(10)
3190	-83	-80	-83	-80	-73	-81	-51	-43	-32	-22
3200	-81	-75	-76	-75	-66	-68	-13	-24	-35	-47
3210	-57	-67	-58	-46	-27	-13	-2	8	18	30
3220	-78	-67	-58	-46	-27	-13	-2	8	18	30
3230	40	50	54	58	62	63	60	54	47	37
3240	29	17	5	-6	-17	-29	-39	-46	-48	90
3250	-44	-38	-28	-14	3	19	36	55	74	90
3260	100	106	110	114	114	110	103	96	87	78
3270	67	56	46	38	33	27	22	19	18	21
3280	27	32	38	48	58	65	70	73	74	72
3290	67	61	54	45	36	23	8	-6	-18	-28
3300	-36	-41	-44	-44	-39	-44	-29	-22	-18	12
3310	31	46	50	74	85	94	100	101	100	97
3320	89	74	58	42	24	5	-12	-29	-42	-54
3330	-62	-66	-71	-71	-69	-67	-60	-52	-46	-39
3340	-33	-28	-27	-24	-23	-24	-24	-25	-26	-28
3350	-29	-30	-31	-30	-30	-32	-33	-35	-37	-39
3360	-42	-44	-45	-45	-44	-43	-43	-41	-41	-37
3370	-32	-29	-27	-24	-20	-18	-16	-12	-8	-3
3380	1	5	8	8	8	10	11	10	10	8
3390	5	1	0	0	0	0	0	1	7	6
3400	9	13	17	23	33	45	58	67	76	84
3410	93	101	109	115	119	121	123	122	121	120
3420	117	112	106	100	92	83	74	64	54	46
3430	38	29	21	14	9	4	-1	-2	-1	-1
3440	-1	1	7	12	15	17	18	20	23	24
3450	23	20	17	15	14	14	12	11	16	23
3460	33	43	50	57	65	68	71	73	75	69
3470	62	52	38	25	13	-2	-16	-27	-34	-40
3480	-41	-40	-38	-35	-27	-18	-9	-3	1	6
3490	6	1	-4	-6	-10	-17	-22	-27	-30	-33
3500	-33	-35	-35	-33	-31	-29	-26	-21	-16	-11
3510	-10	-7	-5	-1	-1	-2	-4	-5	-5	-5
3520	-5	-5	-5	-3	-1	0	0	2	5	7
3530	8	9	10	12	14	17	17	16	17	18
3540	16	12	9	4	-2	-11	-22	-35	-45	-54
3550	-59	-65	-68	-68	-66	-64	-58	-49	-36	-20
3560	-4	8	23	37	48	56	63	67	68	67
3570	64	60	55	49	42	38	37	36	35	36
3580	40	48	54	61	69	75	80	87	91	94
3590	96	96	97	98	97	95	94	92	89	87
3600	84	80	76	71	63	45	37	28	22	22
3610	15	15	15	15	15	15	15	15	15	15
3620	-35	-38	-40	-40	-40	-40	-40	-40	-40	-40
3630	-88	-94	-100	-104	-105	-106	-104	-101	-96	-91
3640	19	26	32	38	45	50	57	63	63	63
3650	68	74	80	85	91	93	92	91	89	85
3660	78	72	66	58	50	43	35	25	16	9
3680	1	-8	-19	-28	-35	-42	-48	-51	-54	-57
3690	6	5	11	12	13	13	13	12	13	14
3700	14	15	19	23	26	30	35	42	48	52
3710	57	61	65	67	68	67	64	61	58	53
3720										

TO BE CONTINUED

TO BE CONTINUED

CONTINUED(S-2113 N33E)

CONTINUED(S-2113 N33E)

NO.	(1)	(2)	(3)	(4)	(5)	(6)	(7)	(8)	(9)	(10)
4270	37	39	41	44	47	48	49	50	51	51
4280	51	53	52	50	47	45	42	40	34	28
4290	24	19	13	10	8	5	1	-1	-2	-4
4300	-6	-7	-9	-8	-8	-8	-8	-4	-1	0
4310	1	3	6	5	4	2	-1	-5	-8	-13
4320	-17	-22	-27	-33	-35	-39	-42	-45	-47	-48
4330	-47	-44	-43	-40	-38	-36	-37	-34	-32	-29
4340	-15	-9	-2	1	3	8	14	19	25	26
4350	30	34	35	36	38	39	41	43	45	46
4360	31	30	29	29	27	26	26	27	25	25
4370	28	28	28	31	33	34	36	36	36	36
4380	34	37	38	39	40	38	37	36	35	33
4390	31	30	30	29	26	22	18	15	12	10
4400	8	5	4	3	0	-1	-4	-7	-12	-21
4410	-26	-31	-37	-43	-48	-53	-57	-59	-62	-65
4420	-65	-67	-70	-74	-68	-68	-70	-72	-74	-74
4430	-73	-73	-74	-74	-72	-65	-58	-49	-40	-29
4440	-16	-1	12	24	35	43	50	58	64	67
4450	69	70	69	66	60	52	41	35	29	20
4460	12	5	0	-2	-5	-6	-5	-5	-3	-1
4470	1	2	6	7	9	10	9	8	7	0
4480	-1	-6	-11	-16	-21	-26	-31	-35	-35	-35
4490	-34	-34	-30	-29	-29	-25	-20	-19	-16	-13
4500	-13	-10	-8	-6	-6	-6	-6	-5	-2	3
4510	5	6	5	7	9	10	12	14	14	14
4520	18	23	24	24	26	29	31	33	36	39
4530	42	45	50	54	55	57	58	60	61	60
4540	57	52	45	39	32	24	17	10	3	2
4550	-8	-13	-19	-26	-32	-38	-45	-51	-57	-61
4560	-65	-69	-72	-75	-77	-77	-78	-80	-80	-79
4570	-77	-73	-68	-62	-57	-53	-47	-38	-30	-23
4580	-17	-12	-9	-8	-7	-6	-5	-6	-7	-9
4590	-11	-14	-16	-17	-23	-29	-33	-39	-41	-42
4600	-43	-42	-40	-41	-40	-36	-32	-29	-27	-24
4610	-22	-19	-17	-14	-11	-8	-5	-2	2	5
4620	7	10	11	15	17	20	24	28	29	30
4630	30	29	30	27	24	21	18	14	10	7
4640	6	6	8	9	10	12	16	21	26	30
4650	36	40	41	41	43	42	41	40	38	36
4660	34	32	28	22	14	9	5	-1	-9	-17
4670	-21	-25	-29	-32	-34	-35	-34	-31	-26	-20
4680	-11	-4	4	14	23	28	32	35	37	38
4690	36	34	30	23	15	7	0	-11	-20	-26
4700	-31	-37	-42	-43	-43	-41	-37	-31	-23	-16
4710	-7	1	11	21	30	36	42	45	46	46
4720	46	45	43	38	35	32	30	26	21	17
4730	14	12	10	9	8	7	5	4	2	0
4740	-1	-1	-4	-3	-3	-5	-5	-5	-6	-8
4750	-1	-6	-8	-8	-8	-9	-9	-9	-11	-14
4760	-13	-16	-19	-18	-17	-18	-18	-18	-15	-11
4770	-13	-10	-12	-14	-15	-14	-14	-14	-13	-10
4780	-19	-8	-6	-5	-2	1	5	5	4	3
4790	3	4	5	5	5	5	8	8	8	10
4800	11	13	13	14	14	14	14	13	12	9

TO BE CONTINUED

TO BE CONTINUED

CONTINUED(S-2113 N33E)

NO.	(1)	(2)	(3)	(4)	(5)	(6)	(7)	(8)	(9)	(10)
5350	30	33	35	35	35	35	35	36	36	36
5360	36	34	31	30	30	30	30	27	23	21
5370	21	18	17	13	13	13	13	13	12	9
5380	6	3	1	-3	-9	-14	-19	-25	-31	-38
5390	-44	-48	-52	-54	-56	-58	-61	-62	-63	-61
5400	-57	-54	-50	-43	-35	-27	-17	-9	-1	7
5410	17	26	31	37	41	44	46	48	46	45
5420	44	44	43	41	42	43	41	39	40	41
5430	40	40	40	40	39	37	34	32	28	28
5440	23	17	11	6	0	-6	-14	-22	-28	-33
5450	-39	-44	-49	-51	-53	-53	-53	-54	-54	-54
5460	-54	-55	-55	-54	-54	-56	-58	-60	-60	-60
5470	-60	-61	-63	-63	-60	-59	-60	-58	-53	-48
5480	-83	-78	-73	-75	-19	-15	-8	5	0	4
5490	6	8	9	10	10	8	6	5	4	2
5500	0	-3	-5	-7	-8	-10	-9	-7	-6	-5
5510	-3	-2	-2	-2	0	0	2	5	5	4
5520	4	7	8	8	8	7	6	7	7	7
5530	8	7	7	8	9	9	10	11	13	14
5540	14	13	11	11	12	11	9	8	5	5
5550	1	-1	-4	-7	-8	-10	-12	-12	-12	-12
5560	-13	-15	-15	-15	-15	-16	-18	-19	-17	-15
5570	-14	-12	-11	-9	-8	-9	-11	-12	-11	-11
5580	-11	-11	-10	-10	-10	-9	-9	-9	-9	-9
5590	-8	-10	-10	-12	-14	-15	-16	-18	-20	-20
5600	-22	-24	-23	-25	-24	-23	-23	-22	-23	-22
5610	-20	-20	-19	-19	-19	-19	-20	-20	-24	-24
5620	-24	-24	-24	-24	-24	-24	-21	-19	-15	-13
5630	-11	-8	-5	-2	1	7	10	14	17	21
5640	24	25	24	23	23	24	22	20	20	19
5650	17	17	17	16	16	14	12	11	10	10
5660	9	9	9	9	9	11	13	14	16	18
5670	20	22	25	26	27	29	29	30	28	27
5680	26	24	22	21	19	18	16	14	14	14
5690	13	11	11	10	10	10	10	10	10	10
5700	10	9	7	6	3	0	0	-1	-2	-3
5710	-2	-1	-1	-1	0	0	3	5	8	10
5720	-11	-14	-19	-22	-23	-24	-24	-26	-25	-24
5730	22	19	16	10	5	1	-1	-6	-2	-9
5740	-24	-27	-31	-37	-40	-42	-45	-45	-45	-45
5750	-44	-43	-40	-38	-37	-35	-28	-24	-18	-13
5760	-13	-10	-8	-4	-5	-5	-1	-1	4	8
5770	8	9	10	10	13	16	16	15	19	19
5780	21	21	19	16	15	13	12	11	13	13
5790	14	14	14	13	16	18	19	22	24	26
5800	26	29	29	29	26	25	27	28	27	26
5810	24	22	21	20	21	23	23	25	29	29
5820	30	29	30	31	33	32	32	33	31	29
5830	29	29	29	29	28	28	28	27	26	25
5840	20	18	17	16	16	14	12	11	11	12
5850	13	13	15	15	15	14	13	11	11	11
5860	12	11	9	8	5	4	4	4	5	2
5870	0	0	1	3	2	1	2	2	2	1
5880	1	0	-2	-7	-9	-10	-12	-14	-15	-14

TO BE CONTINUED

CONTINUED(S-2113 N33E)

NO.	(1)	(2)	(3)	(4)	(5)	(6)	(7)	(8)	(9)	(10)
5890	-15	-18	-19	-21	-23	-22	-21	-23	-20	-21
5900	-24	-25	-25	-24	-24	-23	-26	-24	-25	-29
5910	-33	-31	-32	-34	-37	-41	-44	-48	-50	-52
5920	-54	-57	-61	-63	-64	-65	-66	-67	-69	-68
5930	-65	-62	-61	-61	-58	-55	-49	-46	-45	-38
5940	-31	-23	-18	-15	-9	0	6	10	14	17
5950	19	20	23	26	27	26	26	26	25	22
5960	20	18	17	17	17	16	17	18	19	21
5970	23	28	34	38	42	48	52	54	56	58
5980	59	57	57	56	53	50	47	41	37	34
5990	29	26	24	23	23	23	23	24	26	27

END

RECORD = S-2113 COMPONENT = W33N STATION = YAMASHITA-HEN-S
 DATE AND TIME = 1987-12-17-11-08 TOTAL NUMBER OF DATA = 6000
 SAMPLING INTERVAL = 0.010 (SEC) SCAL = 0.10000
 SIGNAL = GR. ACC.
 CONNECTION POINT IN DATA NUMBER = 2933, 6000, 6000.

CONTINUED (S-2113 W33N)
 NO. (1) (2) (3) (4) (5) (6) (7) (8) (9) (10)

NO.	(1)	(2)	(3)	(4)	(5)	(6)	(7)	(8)	(9)	(10)
0	-7	-7	-7	-7	-7	-7	-6	-6	-6	-5
10	-5	-4	-4	-4	-3	-2	-2	-1	-1	-1
20	0	0	0	0	0	0	0	0	0	0
30	0	-1	-1	-1	-1	-1	-1	-1	-1	-1
40	-8	-9	-11	-12	-12	-12	-13	-13	-13	-13
50	-11	-9	4	8	12	15	19	22	24	9
60	25	26	25	24	22	21	18	14	9	13
70	3	2	-9	-15	-20	-23	-24	-25	-24	9
80	-19	-17	-15	-12	-7	-3	1	5	9	13
90	14	14	14	14	14	14	14	14	11	6
100	1	-3	-7	-10	-12	-9	-5	-4	-3	-3
110	-1	0	-1	-1	-2	-2	-2	0	0	0
120	0	-1	-1	-1	-1	-1	-1	-1	-1	-1
130	0	0	-2	-2	-2	-2	-2	-2	-2	-2
140	-29	-30	-31	-30	-30	-27	-21	-15	-7	-2
150	-1	3	5	6	8	9	11	9	8	6
160	4	4	4	4	4	4	4	4	4	4
170	-14	-9	-4	-1	2	0	0	-2	-2	-4
180	-6	-9	-15	-19	-22	-23	-21	-18	-15	-12
190	-3	0	0	1	4	12	12	12	12	12
200	12	9	4	-1	-9	-17	-25	-30	-33	-35
210	-37	-39	-34	-24	-24	-12	1	9	19	25
220	30	34	34	36	34	27	14	-2	-23	-42
230	-59	-68	-71	-70	-65	-50	-30	-9	4	16
240	25	35	41	44	47	37	22	6	-10	-10
250	-27	-44	-56	-63	-65	-61	-50	-34	-15	-15
260	0	15	27	33	30	24	15	2	-11	-24
270	-33	-41	-46	-50	-52	-52	-45	-29	-4	-4
280	26	52	72	82	85	85	79	69	55	39
290	23	6	-10	-29	-46	-59	-68	-74	-76	-75
300	-70	-61	-48	-34	-22	-11	8	16	20	20
310	22	22	20	17	12	6	0	-2	-3	-6
320	-9	-10	-12	-10	-7	-5	-3	-2	-2	-2
330	-1	-1	-2	-1	3	0	0	0	0	0
340	-7	-5	-4	-4	-3	-3	-3	-3	-3	-3
350	-10	-15	-18	-21	-22	-21	-18	-14	-10	-10
360	-11	-12	-10	-6	-5	4	12	19	23	25
370	28	25	22	15	9	1	-4	-11	-19	-23
380	-26	-39	-34	-30	-31	-20	-9	0	13	22
390	28	30	31	30	27	22	14	4	-4	-10
400	-17	-19	-19	-13	-11	3	11	18	22	22
410	24	25	22	16	7	-4	-17	-30	-42	-51
420	-57	-56	-56	-37	-26	-16	-8	-3	0	4
430	9	13	14	9	-1	-17	-34	-50	-60	-66
440	-69	-67	-59	-44	-21	8	38	64	85	102
450	110	113	113	107	96	80	58	29	0	-25
460	-49	-71	-89	-100	-105	-103	-92	-69	-47	-27
470	-7	6	13	15	16	15	9	2	-3	-12
480	-20	-32	-42	-46	-43	-36	-27	-14	-4	1

TO BE CONTINUED

TO BE CONTINUED

CONTINUED(S-2113 W33N)

CONTINUED(S-2113 W33N)

NO.	(1)	(2)	(3)	(4)	(5)	(6)	(7)	(8)	(9)	(10)
1030	-67	-70	-65	-66	-13	21	54	97	166	195
1040	248	291	325	363	390	401	404	402	395	375
1050	346	309	254	195	136	76	0	-76	-135	-170
1060	-195	-215	-240	-260	-245	-249	-247	-246	-249	-249
1070	-249	-252	-257	-266	-280	-297	-314	-329	-342	-348
1080	-351	-350	-345	-306	-277	-252	-233	-220	-211	-211
1090	-207	-206	-204	-204	-209	-214	-218	-220	-223	-215
1100	-191	-139	-69	-10	61	97	150	198	238	269
1110	290	301	306	305	292	289	282	206	170	123
1120	65	52	70	-129	-184	-286	-279	-349	-407	-453
1130	-511	-566	-591	-599	-599	-580	-530	-445	-348	-256
1140	-158	-48	56	139	209	274	339	408	466	537
1150	585	621	647	655	633	639	611	573	527	482
1160	436	392	348	307	233	233	208	171	122	42
1170	63	7	-54	-125	-179	-224	-282	-342	-411	-469
1180	-517	-544	-554	-554	-539	-505	-377	-282	-183	-183
1190	-89	90	178	255	337	439	505	545	565	565
1200	563	536	483	404	293	183	74	-19	-89	-125
1210	-136	-134	-118	-90	-58	-27	-5	7	11	8
1220	-8	-35	-68	-100	-120	-133	-136	-129	-106	-70
1230	-33	137	15	-152	-283	-366	-412	-430	-431	-419
1240	203	203	137	15	-152	-283	-366	-412	-430	-431
1250	-390	-344	-288	-233	-171	-86	18	115	202	268
1260	319	360	386	396	399	398	391	374	344	299
1270	247	193	140	85	29	-16	-53	-88	-119	-143
1280	-162	-178	-193	-205	-216	-228	-239	-244	-240	-223
1290	-192	-146	-88	-25	31	74	96	106	105	88
1300	47	-5	-54	-86	-101	-105	-101	-88	-61	-28
1310	0	22	38	52	65	77	87	95	96	91
1320	81	66	44	19	-1	-12	-13	-4	17	40
1330	55	65	65	59	38	-1	-56	-135	-220	-307
1340	-388	-453	-509	-535	-537	-518	-477	-416	-336	-247
1350	-163	-47	63	157	237	315	382	411	419	417
1360	404	383	358	329	300	271	245	224	210	198
1370	185	170	149	124	97	61	24	3	-25	-43
1380	-58	-67	-71	-68	-62	-55	-49	-41	-36	-36
1390	-35	-35	-41	-51	-60	-67	-69	-70	-66	-54
1400	-36	-18	-1	21	50	85	123	158	186	203
1410	208	205	190	164	130	99	68	36	5	-24
1420	-50	-74	-91	-100	-103	-97	-83	-58	-28	-24
1430	36	59	71	77	75	71	63	47	69	69
1440	29	15	7	5	11	26	48	67	74	69
1450	54	22	-27	-78	-118	-144	-157	-161	-159	-152
1460	-134	-110	4	49	49	49	102	148	176	189
1470	194	186	167	139	96	33	-49	-132	-202	-254
1480	-280	-276	-280	-276	-265	-247	-235	-222	-210	-194
1490	-157	-128	-93	-66	-50	-43	-42	-49	-65	-79
1500	-86	-87	-85	-73	-59	-46	-35	-26	-16	-9
1510	-2	7	14	21	26	31	34	41	48	66
1520	89	116	154	194	226	269	305	323	336	344
1530	347	342	323	290	246	194	132	78	44	17
1540	0	-8	-15	-22	-33	-57	-93	-127	-164	-199
1550	-229	-267	-306	-334	-348	-354	-350	-333	-297	-248
1560	-187	-106	-12	75	153	221	289	344	375	388

TO BE CONTINUED

TO BE CONTINUED

NO.	(1)	(2)	(3)	(4)	(5)	(6)	(7)	(8)	(9)	(10)
2110	51	54	54	57	63	72	80	87	93	97
2120	34	86	73	59	45	35	29	28	30	31
2130	95	43	52	60	65	66	64	62	60	58
2140	55	52	51	50	48	40	26	7	-17	-41
2150	-59	-74	-88	-95	-98	-84	-72	-45	-59	-45
2160	-32	-21	-14	-8	4	2	2	-3	-5	-9
2170	-17	-33	-51	-67	-81	-94	-102	-105	-103	-98
2180	-89	-84	-77	-74	-72	-70	-69	-69	-69	-68
2190	-63	-59	-53	-46	-41	-34	-27	-21	-14	-10
2200	-5	2	0	0	1	2	2	2	3	3
2210	5	10	15	23	28	38	52	57	62	67
2220	68	66	64	60	58	54	47	40	34	29
2230	25	21	18	22	22	21	19	21	18	13
2240	4	-4	-10	-18	-23	-27	-29	-28	-26	-24
2250	-20	-10	-2	6	18	27	33	38	45	51
2260	53	52	50	46	39	28	15	1	-10	-28
2270	-51	-74	-94	-106	-112	-114	-113	-111	-109	-99
2280	-89	-78	-68	-61	-53	-41	-29	-20	-9	-6
2290	22	37	54	71	91	109	122	133	142	146
2300	147	144	139	131	123	115	104	92	78	58
2310	31	4	-16	-32	-46	-58	-66	-73	-80	-89
2320	-97	-99	-98	-96	-91	-87	-82	-78	-76	-78
2330	-81	-87	-96	-106	-116	-126	-136	-148	-150	-150
2340	-152	-151	-138	-120	-98	-78	-59	-40	-22	-6
2350	6	16	26	35	43	49	57	65	72	75
2360	79	84	89	93	95	95	94	91	90	88
2370	88	85	84	82	83	82	78	82	87	95
2380	106	114	118	122	126	125	125	125	123	118
2390	110	100	92	88	83	75	70	67	63	59
2400	52	41	32	22	14	7	0	-5	-11	-16
2410	-24	-30	-31	-30	-25	-17	-8	1	14	26
2420	36	63	66	48	47	45	43	39	35	32
2430	29	25	20	16	11	7	4	0	-3	-5
2440	-8	-11	-14	-17	-21	-26	-31	-35	-39	-44
2450	-51	-56	-58	-58	-57	-56	-60	-62	-65	-72
2460	-78	-85	-90	-94	-100	-104	-102	-94	-85	-70
2470	-49	-28	-5	20	46	70	90	108	118	135
2480	123	115	99	68	26	-17	-58	-88	-108	-131
2490	-126	-123	-109	-92	-71	-41	-6	24	51	77
2500	101	118	124	128	130	130	125	122	118	115
2510	117	119	124	130	139	150	162	174	186	195
2520	200	202	194	172	141	99	47	-6	-50	-86
2530	-138	-162	-177	-186	-188	-183	-169	-139	-96	-62
2540	84	30	67	92	110	120	125	125	119	105
2550	-10	62	40	17	1	-9	-20	-27	-32	-33
2560	-31	-25	-16	-5	5	16	22	25	28	30
2570	29	25	14	2	-12	-25	-40	-56	-67	-74
2580	-78	-77	-72	-65	-56	-46	-35	-22	-8	4
2590	15	20	23	23	19	12	3	-1	-8	-14
2600	-20	-24	-26	-26	-26	-24	-24	-26	-26	-26
2610	-24	-19	-11	-4	2	8	13	15	16	15
2620	14	12	10	10	10	11	14	16	18	24
2630	32	40	46	51	54	54	53	52	39	21
2640	-19	-41	-41	-64	-87	-106	-127	-140	-145	-149

TO BE CONTINUED

TO BE CONTINUED

CONTINUED(S-2113 W33N)

NO.	(1)	(2)	(3)	(4)	(5)	(6)	(7)	(8)	(9)	(10)
3190	17	12	7	1	-4	-7	-12	-17	-24	-30
3200	-37	-45	-51	-56	-61	-65	-67	-63	-58	-50
3210	-39	-28	-13	-1	11	25	37	47	53	58
3220	62	62	59	53	44	32	15	0	-12	-21
3230	-59	-53	-35	-32	-25	-18	-10	-1	6	15
3240	25	32	37	41	44	46	46	46	46	46
3250	45	45	44	43	42	42	42	41	40	37
3260	33	29	24	19	19	0	-9	-18	-25	-31
3270	-34	-33	-30	-26	-21	-16	-7	0	9	18
3280	26	30	32	34	35	36	36	36	36	37
3290	40	43	44	46	45	43	40	36	32	27
3300	19	5	8	-2	-36	-47	-55	-61	-64	-64
3310	-61	-55	-45	-32	-21	-8	4	16	26	36
3320	42	47	51	58	62	62	67	70	70	70
3330	68	66	64	61	59	54	48	41	31	21
3340	7	6	-19	-32	-45	-56	-66	-75	-83	-92
3350	-99	-104	-109	-112	-114	-114	-111	-109	-106	-102
3360	-97	-91	-80	-69	-57	-44	-33	-21	-8	2
3370	13	22	31	37	40	42	41	38	34	30
3380	25	17	10	3	-1	-6	-10	-12	-14	-16
3390	-17	-17	-17	-17	-17	-17	-18	-20	-22	-21
3400	-19	-17	-16	-14	-11	-9	-7	-4	-1	2
3410	7	10	14	21	28	35	43	51	58	65
3420	72	81	90	98	105	109	110	110	108	104
3430	99	87	68	46	20	-5	-27	-45	-60	-71
3440	-78	-83	-85	-83	-77	-69	-60	-51	-39	-27
3450	-16	-6	3	13	19	24	28	32	37	42
3460	43	43	39	36	33	28	22	16	10	6
3470	2	-1	-4	-5	-5	-1	6	17	31	44
3480	58	71	83	96	106	112	116	116	112	105
3490	95	81	67	52	36	21	11	1	-4	-8
3500	-10	-10	-10	-10	-10	-12	-12	-16	-18	-25
3510	-31	-38	-45	-53	-60	-65	-69	-72	-73	-71
3520	-68	-65	-60	-53	-44	-33	-21	-7	4	17
3530	29	40	49	57	62	63	64	62	58	52
3540	45	37	29	20	9	0	-8	-13	-16	-16
3550	-12	-8	-3	0	5	9	12	15	17	19
3560	18	15	13	10	5	1	-1	-2	0	3
3570	9	17	25	34	42	49	55	60	62	63
3580	63	59	50	37	21	5	-7	-18	-27	-33
3590	-37	-37	-35	-33	-31	-27	-21	-15	-11	-7
3600	-4	-3	0	1	0	-1	-3	-3	-4	-6
3610	-9	-11	-15	-17	-20	-22	-23	-24	-25	-23
3620	-19	-17	-15	-12	-8	-5	-1	6	11	14
3630	17	19	19	17	14	9	2	-4	-9	-16
3640	-22	-25	-27	-26	-25	-24	-23	-24	-22	-19
3650	-16	-14	-10	-9	-8	-7	-7	-8	-9	-10
3660	68	72	71	67	60	48	30	10	-7	62
3670	68	72	71	67	60	48	30	10	-7	62
3680	-37	-49	-58	-65	-69	-69	-65	-58	-48	-36
3690	-23	-10	2	16	28	35	37	36	31	24
3700	16	5	-6	-15	-23	-28	-30	-30	-28	-24
3710	-18	-12	-6	0	8	14	19	25	30	31
3720	33	34	36	39	42	45	49	56	63	68

TO BE CONTINUED

CONTINUED(S-2113 W33N)

NO.	(1)	(2)	(3)	(4)	(5)	(6)	(7)	(8)	(9)	(10)
3730	73	78	82	83	84	83	81	75	68	59
3740	48	36	21	6	-7	-20	-28	-34	-40	-45
3750	-45	-46	-47	-44	-42	-38	-35	-33	-33	-33
3760	-33	-33	-33	-33	-31	-28	-27	-25	-25	-25
3770	-22	-20	-17	-10	-4	2	7	14	23	29
3780	35	41	48	54	63	70	74	73	71	68
3790	62	53	43	32	21	10	0	-9	-16	-22
3800	-26	-29	-27	-23	-17	-10	-3	0	7	17
3810	40	49	56	61	62	60	58	52	43	34
3820	25	16	6	-2	-9	-16	-21	-28	-33	-37
3830	-39	-40	-41	-41	-37	-32	-29	-28	-25	-21
3840	-18	-15	-13	-12	-12	-12	-14	-17	-19	-21
3850	-23	-28	-36	-42	-46	-50	-54	-57	-59	-58
3860	-56	-53	-51	-50	-47	-44	-40	-35	-30	-29
3870	-28	-26	-24	-22	-22	-22	-24	-23	-21	-20
3880	-18	-19	-20	-19	-18	-16	-14	-13	-9	5
3890	18	19	15	10	-7	-5	0	6	12	17
3900	2	0	-1	-4	-5	-6	-5	-5	-4	-4
3910	-5	-4	-3	-3	-3	-3	-3	-2	-2	-3
3920	-4	-3	-5	-5	-7	-9	-10	-9	-9	-8
3930	-3	3	10	14	19	26	31	35	40	46
3940	52	57	59	61	63	64	65	66	65	66
3950	63	62	61	60	58	54	50	46	40	33
3960	25	18	12	8	4	0	-2	-1	0	0
3970	0	4	9	14	20	26	34	41	47	50
3980	53	54	54	51	47	43	36	28	18	9
3990	0	-10	-9	-25	-30	-32	-32	-30	-28	-23
4000	-16	-8	0	8	18	25	31	35	38	40
4010	40	39	36	32	25	16	6	0	-6	-13
4020	-18	-22	-25	-27	-27	-23	-18	-12	-6	0
4030	5	10	15	18	22	26	28	28	26	25
4040	23	20	17	12	8	3	0	5	8	12
4050	-16	-20	-24	-30	-35	-39	-45	-51	-55	-59
4060	-63	-67	-69	-69	-69	-70	-69	-66	-61	-56
4070	-51	-45	-40	-32	-26	-21	-13	-9	-4	4
4080	13	20	28	36	42	48	53	55	56	58
4090	59	58	56	54	50	43	36	30	23	15
4100	8	2	-4	-10	-15	-19	-25	-32	-38	-41
4110	-43	-44	-44	-42	-39	-37	-35	-31	-27	-21
4120	27	27	27	27	25	22	20	18	17	15
4130	12	10	9	9	9	11	15	18	21	25
4140	30	38	45	52	63	75	86	97	105	111
4150	115	118	119	118	115	102	93	83	74	64
4160	66	57	50	45	39	34	30	24	19	13
4170	9	5	-1	-7	-11	-20	-30	-42	-52	-63
4180	-78	-94	-106	-113	-116	-119	-120	-120	-117	-117
4190	-111	-101	-89	-76	-64	-49	-34	-20	-7	2
4200	10	16	19	19	19	18	16	12	7	0
4210	0	-6	-11	-17	-22	-29	-34	-37	-38	-42
4220	-6	-11	-17	-22	-29	-34	-37	-38	-42	-44
4230	-45	-45	-45	-45	-41	-39	-38	-34	-30	-24
4240	-27	-26	-23	-21	-19	-19	-20	-22	-24	-27
4250	-29	-29	-31	-34	-36	-37	-39	-38	-36	-33
4260	-31	-27	-24	-22	-22	-20	-19	-19	-20	-20

TO BE CONTINUED

CONTINUED(S-2113 W33N)

CONTINUED(S-2113 W33N)

NO.	(1)	(2)	(3)	(4)	(5)	(6)	(7)	(8)	(9)	(10)
4270	-22	-26	-29	-32	-36	-44	-52	-61	-68	-74
4280	-79	-83	-86	-87	-87	-83	-76	-67	-56	-42
4290	-29	-16	12	13	27	39	50	58	64	70
4300	73	75	74	73	71	65	59	54	49	46
4310	44	41	37	34	33	30	30	30	30	30
4320	29	29	29	28	27	29	29	28	27	29
4330	28	25	23	20	15	7	-1	-9	-17	-29
4340	-38	-48	-54	-59	-64	-67	-68	-68	-67	-65
4350	-64	-61	-58	-54	-49	-45	-42	-37	-34	-30
4360	-28	-22	-19	-14	-8	0	7	11	15	20
4370	24	28	28	27	27	26	24	22	19	14
4380	8	3	0	-2	-5	-7	-9	-8	-6	-4
4390	-5	-5	-4	-4	-5	-2	-2	-2	-2	-4
4400	-5	-4	-4	-4	-2	0	3	8	12	15
4410	19	23	26	27	27	27	26	24	22	18
4420	15	12	9	7	5	3	3	2	3	5
4430	8	11	13	14	14	14	14	14	14	14
4440	14	14	13	13	14	15	17	19	22	25
4450	28	32	36	40	44	47	50	53	56	57
4460	58	60	60	61	60	59	58	56	54	53
4470	50	47	43	41	37	33	30	29	25	23
4480	20	19	17	16	17	17	16	16	16	15
4490	10	6	2	-1	-6	-9	-14	-19	-24	-27
4500	-31	-34	-37	-39	-39	-40	-40	-42	-43	-41
4510	-40	-40	-40	-40	-39	-39	-37	-35	-32	-28
4520	-24	-17	-10	-3	6	15	25	34	42	48
4530	52	55	56	56	55	52	47	39	30	21
4540	12	2	-9	-19	-29	-40	-50	-63	-80	-97
4550	-71	-73	-75	-74	-72	-68	-63	-58	-53	-50
4560	-45	-41	-36	-31	-26	-25	-24	-21	-18	-17
4570	-16	-13	-9	-5	0	4	9	14	19	22
4580	26	27	27	24	22	19	16	9	4	0
4590	-4	-8	-11	-12	-11	-9	-8	-6	-5	-5
4600	-4	-2	-1	0	-1	-4	-4	-5	-7	-11
4610	-13	-15	-18	-18	-19	-18	-18	-17	-15	-12
4620	-8	-5	-3	0	2	6	7	9	10	11
4630	11	12	14	12	12	12	13	14	14	16
4640	19	23	25	29	30	33	34	35	33	31
4650	28	24	19	12	5	-2	-8	-14	-17	-20
4660	-22	-25	-27	-26	-23	-22	-21	-20	-18	-15
4670	-12	-9	-6	-5	-3	-2	-2	-2	-2	-2
4680	-5	-8	-11	-13	-15	-17	-19	-21	-23	-25
4690	-26	-28	-29	-31	-35	-37	-38	-40	-43	-45
4700	-45	-45	-43	-43	-42	-41	-40	-36	-33	-30
4710	-29	-28	-25	-23	-21	-21	-22	-22	-20	-19
4720	-18	-16	-14	-9	5	1	15	16	18	18
4730	21	22	23	23	22	20	15	10	5	0
4740	-4	-9	-11	-16	-20	-21	-22	-20	-17	-17
4750	-14	-12	-7	-2	1	8	14	18	23	27
4760	31	30	30	29	26	21	15	6	-1	-12
4770	-23	-34	-44	-52	-57	-62	-64	-66	-64	-63
4780	-60	-54	-48	-42	-35	-30	-23	-19	-15	-10
4790	-6	-3	0	3	6	8	12	17	20	21
4800	23	26	30	33	35	39	43	46	50	54

TO BE CONTINUED

TO BE CONTINUED

CONTINUED(S-2113 W33N)

NO.	(1)	(2)	(3)	(4)	(5)	(6)	(7)	(8)	(9)	(10)
5350	-41	-37	-33	-30	-27	-22	-17	-15	-10	-6
5360	-2	2	6	13	18	23	28	32	37	42
5370	44	47	51	53	54	56	56	56	55	53
5380	51	68	45	41	37	29	22	16	10	4
5390	0	-3	-7	-10	-13	-16	-18	-18	-19	-19
5400	-17	-16	-14	-11	-10	-7	-5	-4	-4	-5
5410	-5	-6	-8	-11	-16	-20	-23	-26	-29	-32
5420	-36	-41	-44	-45	-46	-49	-51	-53	-55	-56
5430	-57	-57	-57	-57	-56	-54	-53	-51	-48	-44
5440	-39	-33	-26	-19	-15	-9	-6	-1	3	4
5450	9	14	16	16	17	20	20	20	20	20
5460	21	19	15	12	8	2	-1	-5	-10	-16
5470	-11	-25	-29	-30	-29	-30	-30	-28	-24	-18
5480	-1	-7	-4	0	4	9	11	11	11	14
5490	15	16	15	13	11	10	9	9	7	6
5500	8	8	7	7	8	9	9	9	9	10
5510	11	11	11	12	12	12	12	9	7	5
5520	3	2	1	0	0	-1	-2	-2	-2	0
5530	-3	-2	-2	-2	-2	-1	-1	0	0	0
5540	0	0	-3	-5	-6	-8	-11	-13	-16	-17
5550	-18	-18	-18	-18	-17	-16	-14	-11	-10	-10
5560	-9	-7	-7	-6	-5	-3	0	2	3	4
5570	7	9	12	14	16	17	19	21	23	25
5580	26	27	27	28	30	31	31	31	30	28
5590	26	24	22	20	19	17	13	10	9	7
5600	4	5	6	6	6	7	10	12	14	15
5610	16	19	20	19	19	19	20	21	21	21
5620	20	20	21	21	20	19	17	16	16	16
5630	15	12	12	11	8	5	1	0	-2	-4
5640	-5	-7	-9	-11	-12	-12	-16	-18	-21	-23
5650	-25	-27	-28	-28	-28	-29	-28	-27	-26	-26
5660	-22	-16	-12	-10	-6	-2	2	9	14	17
5670	22	28	34	38	42	47	52	56	60	62
5680	66	69	71	72	73	71	69	66	62	57
5690	52	46	39	33	26	20	15	10	4	-1
5700	-6	-11	-17	-22	-26	-30	-33	-35	-38	-41
5710	-43	-45	-47	-48	-47	-43	-49	-49	-48	-45
5720	-41	-37	-32	-28	-25	-20	-16	-12	-7	-1
5730	2	5	8	10	13	16	17	18	20	21
5740	21	22	20	20	22	22	22	24	23	24
5750	21	20	18	15	11	10	6	1	0	-3
5760	-5	-8	-13	-14	-14	-15	-18	-20	-20	-19
5770	-18	-18	-18	-16	-14	-10	-8	-6	-5	-5
5780	-3	-3	-1	0	0	0	-1	-3	-4	-4
5790	-4	-4	-4	-4	-4	-5	-5	-5	-5	-5
5800	-5	-5	-6	-7	-7	-7	-7	-7	-7	-7
5810	-10	-9	-8	-7	-6	-5	-3	1	6	11
5820	15	19	23	27	32	37	42	45	47	51
5830	55	58	61	62	62	63	63	61	60	61
5840	61	59	57	56	54	54	53	52	50	47
5850	44	40	36	32	28	23	16	10	5	-2
5860	-7	-13	-19	-23	-27	-31	-36	-37	-37	-37
5870	-40	-39	-38	-36	-34	-31	-27	-28	-26	-24
5880	-22	-18	-16	-14	-14	-15	-14	-13	-13	-15

TO BE CONTINUED

CONTINUED(S-2113 W33N)

NO.	(1)	(2)	(3)	(4)	(5)	(6)	(7)	(8)	(9)	(10)
5890	-15	-14	-14	-15	-15	-15	-15	-12	-10	-10
5900	-8	-5	-5	-5	-4	-4	-4	-4	-3	-2
5910	-3	-3	-3	-4	-4	-4	-4	-4	-3	-2
5920	-5	-5	-5	-7	-7	-7	-7	-8	-5	-5
5930	-13	-13	-13	-15	-13	-13	-14	-15	-11	-12
5940	-10	-10	-10	-10	-9	-8	-8	-9	-8	-8
5950	-9	-9	-7	-6	-5	-3	-2	-1	0	2
5960	5	6	6	4	4	5	5	6	5	4
5970	4	5	4	4	4	4	4	3	4	8
5980	11	13	15	16	16	17	18	19	19	19
5990	21	23	24	23	22	22	23	25	26	27

END

RECORD = S-2113 COMPONENT = DOWN STATION = YAMASHITA-NEM-S
 DATE AND TIME = 1987-12-17-11-08 TOTAL NUMBER OF DATA = 6000
 SAMPLING INTERVAL = 0.010 (SEC) SCAL = 0.10000
 SIGNAL = GR ACC.
 CONNECTION POINT IN DATA NUMBER = 2934, 6000, 6000

CONTINUED(S-2113 DOWN)

NO.	(1)	(2)	(3)	(4)	(5)	(6)	(7)	(8)	(9)	(10)
0	-20	-18	-17	-15	-14	-12	-11	-9	-8	-6
10	-4	-3	-1	0	3	6	9	12	16	21
20	25	29	33	37	40	43	45	48	48	49
30	49	48	46	45	42	40	35	31	25	18
40	11	-7	-20	-32	-43	-53	-57	-59	-58	-58
50	-56	-49	-40	-26	-11	6	9	12	15	15
60	17	18	17	16	14	12	10	8	7	28
70	6	5	3	0	-5	-13	-20	-30	-30	4
80	-29	-25	-21	-18	-16	-18	-23	-30	-37	29
90	-44	-44	-41	-33	-26	-18	-10	-1	8	16
100	24	29	30	30	29	28	27	27	28	28
110	31	33	34	34	34	29	22	14	8	5
120	6	11	18	23	27	28	26	22	16	10
130	6	3	2	1	-1	-2	-2	-1	0	0
140	0	-3	-8	-13	-19	-23	-26	-28	-24	-19
150	-8	0	9	15	19	20	19	19	19	19
160	21	25	27	31	36	41	45	50	54	55
170	54	50	47	42	33	23	11	-1	-13	-20
180	-25	-28	-30	-35	-36	-39	-41	-39	-34	-34
190	-26	-24	-24	-26	-28	-30	-30	-25	-18	-11
200	-7	-4	-3	0	0	0	0	-4	-8	-11
210	-12	-11	-10	-11	-12	-16	-17	-18	-17	-14
220	-8	-1	4	9	14	15	12	7	0	-5
230	-7	-7	-3	1	6	7	5	0	-9	-25
240	-42	-54	-61	-61	-46	-19	12	35	43	44
250	39	29	19	12	25	24	19	15	9	8
260	5	8	15	22	25	20	14	10	8	14
270	11	16	21	23	20	14	10	8	9	-2
280	22	30	38	42	43	42	35	22	22	9
290	-13	-24	-34	-43	-48	-51	-53	-54	-54	-56
300	-60	-67	-76	-82	-81	-70	-47	-18	1	14
310	23	28	32	35	30	26	23	24	27	30
320	35	38	38	34	24	11	-2	-15	-19	-21
330	-14	-1	10	20	29	37	42	45	45	42
340	39	34	32	33	34	33	30	25	22	19
350	15	12	7	5	2	2	2	3	3	0
360	-4	-7	-8	-7	-6	-6	-7	-13	-20	-23
370	-26	-27	-27	-27	-27	-27	-26	-27	-31	-38
380	-45	-50	-51	-49	-45	-39	-30	-23	-14	-8
390	-3	-2	-4	-6	-4	-6	-11	-10	1	22
400	57	58	49	38	34	32	36	45	48	43
410	32	20	8	2	0	-5	-13	-21	-29	-31
420	-25	-10	8	22	29	30	25	14	2	-10
430	-21	-8	-2	-2	-31	-28	-22	-14	-6	0
440	3	5	8	12	19	24	24	21	15	9
450	5	-2	-5	-2	-10	-16	-22	-27	-30	-31
460	-29	-35	-45	-55	-65	-74	-81	-85	-82	-80
470	12	31	42	52	63	71	74	64	46	46
480	21	-1	-18	-29	-36	-40	-43	-47	-48	-47

TO BE CONTINUED

TO BE CONTINUED

CONTINUED(S-2113 DOWN)										CONTINUED(S-2113 DOWN)											
NO.	(1)	(2)	(3)	(4)	(5)	(6)	(7)	(8)	(9)	(10)	NO.	(1)	(2)	(3)	(4)	(5)	(6)	(7)	(8)	(9)	(10)
1030	46	39	30	27	11	5	0	0	0	7	1570	-88	-76	-63	-54	-47	-64	-44	-47	-50	-51
1040	20	31	36	30	30	21	13	3	5	-2	1580	-50	-48	-45	-42	-39	-40	-42	-44	-48	-51
1050	8	-17	-29	-37	-41	-38	-27	-9	11	32	1590	-50	-49	-46	-42	-39	-40	-42	-44	-48	-51
1060	57	77	96	113	125	134	137	136	130	119	1600	0	1	2	0	-4	-9	-11	-12	-13	-13
1070	98	77	58	39	21	1	-17	-36	-48	-55	1610	-11	-9	-6	-3	-2	-3	-4	-7	-8	-9
1080	-61	-65	-69	-74	-77	-72	-68	-63	-56	-50	1620	-2	5	13	21	21	7	4	37	37	37
1090	-46	-43	-42	-37	-29	-17	-5	4	10	13	1630	35	31	25	18	4	7	4	1	1	1
1100	14	14	10	3	-15	-35	-50	-55	-57	-57	1640	0	2	4	5	3	3	-6	-20	-39	-50
1110	-53	-68	-64	-64	-64	-64	-64	-64	-64	-64	1650	-59	-62	-62	-62	-58	-52	-41	-23	-4	22
1120	-49	-52	-60	-60	-76	-81	-86	-88	-88	-85	1660	31	38	42	47	50	49	46	41	37	33
1130	-78	-62	-32	5	40	76	107	130	151	163	1670	29	25	23	25	27	27	28	29	31	31
1140	167	166	159	137	105	70	41	19	1	10	1680	30	27	21	15	11	9	8	7	10	12
1150	-48	-69	-81	-87	-86	-72	-66	-17	7	33	1690	16	20	23	28	29	28	23	18	12	5
1160	58	77	87	89	85	75	62	51	40	30	1700	1	1	-3	-10	-11	-8	-4	0	6	14
1170	23	15	9	4	-2	-6	-9	-16	-26	-39	1710	21	27	31	36	40	43	46	50	57	69
1180	-53	-68	-80	-86	-86	-84	-75	-61	-49	-39	1720	82	90	94	93	87	72	48	22	-1	-23
1190	-32	-26	-20	-15	-10	-3	0	3	2	1	1730	-42	-59	-74	-87	-97	-102	-108	-112	-115	-118
1200	-1	-9	-28	-46	-56	-61	-58	-49	-34	-15	1740	-119	-119	-119	-120	-116	-109	-100	-88	-73	-53
1210	-3	4	9	16	23	28	28	26	24	24	1750	-33	-8	17	42	56	67	78	88	95	99
1220	24	25	28	29	29	29	31	32	34	41	1760	100	99	95	90	82	60	24	-1	-15	-30
1230	44	45	45	46	47	47	48	51	54	59	1770	21	-17	-12	-9	-10	-14	-23	-37	-50	-58
1240	61	62	60	52	38	24	16	13	12	14	1780	-63	-61	-56	-48	-41	-36	-30	-22	-11	-4
1250	15	15	15	12	7	5	2	-3	-5	-11	1790	0	3	2	-4	-4	-22	-26	-27	-25	-21
1260	-32	-43	-51	-60	-66	-69	-70	-70	-69	-69	1800	-15	-11	-6	0	6	15	26	37	50	59
1270	-73	-77	-79	-81	-80	-76	-69	-61	-52	-38	1810	66	71	72	70	66	59	47	30	7	-12
1280	-18	-2	7	15	24	32	38	42	45	51	1820	32	-49	-59	-64	-64	-60	-50	-37	-27	-18
1290	57	60	60	59	55	49	40	32	25	21	1830	-11	-7	-3	-1	0	-3	-9	-20	-39	-61
1300	19	20	23	28	35	45	55	65	75	82	1840	-74	-80	-79	-82	-79	-56	-38	-28	-17	-9
1310	53	44	37	33	29	25	22	22	23	27	1850	0	7	16	25	36	45	50	52	54	57
1320	34	42	47	51	54	56	59	61	65	65	1860	62	67	73	80	85	89	92	94	91	-1
1330	58	58	58	58	58	58	58	58	58	58	1870	87	81	74	65	55	44	31	16	-1	-19
1340	-104	-92	-75	-55	-33	-11	6	20	27	30	1880	-79	-51	-63	-71	-78	-82	-85	-87	-86	-83
1350	27	19	8	0	-3	-2	5	9	12	12	1890	-28	-22	-16	-10	-2	5	14	23	30	33
1360	9	3	-5	-15	-30	-50	-70	-89	-105	-119	1900	31	21	0	-22	-34	-39	-42	-40	-36	-35
1370	-125	-127	-127	-121	-108	-89	-71	-53	-35	-24	1910	0	0	0	0	0	0	0	0	0	0
1380	-14	4	15	30	42	50	56	56	58	57	1920	-36	-39	-47	-58	-64	-68	-70	-71	-72	-71
1390	57	57	59	61	62	63	65	65	64	56	1930	-70	-67	-63	-61	-58	-55	-52	-47	-45	-43
1400	44	26	6	-9	-22	-35	-44	-51	-53	-55	1940	-41	-37	-30	-13	8	25	42	56	68	78
1410	-54	-49	-43	-41	-39	-38	-37	-35	-24	-24	1950	84	87	92	94	94	94	94	94	90	84
1420	1	26	40	51	51	47	42	36	27	27	1960	76	63	48	35	20	3	-12	-23	-30	-35
1430	14	-3	-29	-55	-78	-92	-99	-101	-100	-96	1970	-37	-36	-32	-26	-15	-1	8	16	25	30
1440	-85	-68	-69	-35	-28	-21	-16	-11	-4	2	1980	32	34	36	38	37	32	26	20	15	11
1450	8	15	23	32	43	55	67	78	85	87	1990	9	10	13	18	23	24	24	22	18	13
1460	82	72	61	54	50	49	50	50	49	40	2000	7	1	-3	-9	-16	-24	-32	-39	-42	-46
1470	25	8	-2	-7	-6	-2	3	7	9	9	2010	-50	-51	-52	-54	-56	-55	-51	-41	-24	-8
1480	6	-1	-11	-20	-28	-35	-40	-44	-46	-44	2020	0	5	7	5	3	1	0	4	5	10
1490	-40	-21	-10	0	9	16	21	25	30	30	2030	15	21	25	25	25	24	26	30	34	43
1500	34	37	38	38	39	42	44	48	50	49	2040	55	65	69	69	64	58	50	39	31	23
1510	44	44	44	44	44	44	44	44	44	44	2050	13	5	-6	-17	-26	-34	-40	-44	-48	-52
1520	-79	-84	-83	-80	-76	-73	-71	-69	-66	-65	2060	-55	-56	-55	-55	-51	-45	-40	-44	-48	-52
1530	-63	-59	-54	-42	-29	-13	1	18	38	60	2070	-9	-5	-4	-4	-2	-1	-2	-5	-7	-12
1540	86	105	121	130	138	146	152	157	160	160	2080	-17	-19	-19	-18	-16	-12	-8	-3	3	7
1550	155	144	128	106	78	47	18	-2	-16	-26	2090	14	21	29	37	42	48	52	56	60	64
1560	-36	-44	-54	-65	-76	-88	-96	-101	-102	-98	2100	65	64	61	58	51	41	31	21	14	9

TO BE CONTINUED

TO BE CONTINUED

CONTINUED< S-2113 DOWN >

CONTINUED< S-2113 DOWN >

NO.	(1)	(2)	(3)	(4)	(5)	(6)	(7)	(8)	(9)	(10)
2110	2	-5	-17	-33	-50	-63	-72	-78	-82	-85
2120	-85	-80	-70	-55	-39	-23	-11	52	4	10
2130	13	17	25	45	51	53	51	52	51	49
2140	46	42	39	38	39	41	44	47	50	50
2150	52	54	54	54	54	52	49	47	42	37
2160	32	24	14	3	-8	-18	-24	-27	-28	-26
2170	-20	-10	0	6	11	15	18	19	16	9
2180	0	-7	-13	-19	-22	-23	-25	-24	-22	-18
2190	-13	-8	-3	2	8	18	25	30	33	35
2200	34	32	28	25	22	21	22	23	22	19
2210	17	13	9	7	4	0	-6	-10	-16	-20
2220	-24	-27	-28	-27	-27	-26	-25	-23	-20	-18
2230	-16	-15	-8	-4	3	13	24	30	33	32
2240	23	-5	-15	-35	-48	-57	-62	-65	-64	-62
2250	-59	-56	-52	-47	-42	-37	-33	-28	-21	-13
2260	-7	0	10	19	25	29	32	33	34	35
2270	41	43	45	47	47	46	44	41	39	37
2280	37	36	35	35	32	29	25	23	24	26
2290	27	30	30	30	27	25	18	13	11	11
2300	12	14	19	24	26	28	31	33	36	38
2310	38	38	36	34	30	24	20	15	10	7
2320	7	9	12	15	17	19	20	19	18	17
2330	18	16	14	15	18	22	25	27	29	31
2340	35	39	41	43	44	44	45	47	48	48
2350	46	42	39	38	34	32	29	24	20	14
2360	12	7	3	0	-2	-4	-8	-13	-16	-19
2370	-18	-16	-13	-11	-10	-7	-4	0	0	-1
2380	-4	-6	-5	-5	-6	-7	-8	-9	-11	-12
2390	-11	-7	-3	0	1	3	1	0	-1	-2
2400	-5	-9	-15	-23	-29	-32	-36	-39	-37	-37
2410	-33	-29	-31	-33	-33	-35	-38	-39	-37	-37
2420	6	4	1	-3	-8	-13	-15	-14	-13	-12
2430	-11	-11	-11	-11	-10	-7	-5	0	6	16
2440	29	38	43	45	45	45	45	45	46	46
2450	47	48	47	44	40	32	22	12	5	-5
2460	-18	-29	-39	-47	-55	-61	-64	-65	-65	-65
2470	-65	-64	-62	-62	-63	-62	-60	-58	-53	-49
2480	-46	-43	-39	-36	-33	-31	-30	-29	-24	-20
2490	-15	-10	-4	1	5	9	15	17	23	27
2500	31	36	39	40	41	44	48	49	48	48
2510	47	44	40	35	26	17	7	0	-5	-10
2520	-15	-18	-20	-21	-18	-12	-6	1	8	17
2530	31	44	52	56	60	60	58	54	49	46
2540	48	42	42	43	43	42	42	43	46	48
2550	68	68	68	68	68	68	68	68	68	68
2560	-21	-35	-47	-55	-58	-58	-57	-55	-54	-52
2570	-52	-55	-54	-54	-56	-57	-57	-56	-55	-51
2580	-48	-47	-46	-48	-49	-52	-55	-58	-59	-61
2590	-61	-61	-59	-57	-53	-50	-47	-43	-39	-34
2600	-28	-22	-16	-10	-6	0	5	10	14	18
2610	22	25	26	27	27	26	28	30	33	34
2620	34	33	30	26	21	14	7	0	-3	-7
2630	-8	-7	-6	-5	-5	-5	-5	-6	-8	-9
2640	-10	-11	-11	-12	-14	-16	-17	-20	-24	-25

TO BE CONTINUED

TO BE CONTINUED

CONTINUED (S-2113 DOWN)

NO.	(1)	(2)	(3)	(4)	(5)	(6)	(7)	(8)	(9)	(10)
3190	-2	-2	-1	0	3	4	8	10	11	11
3200	11	11	14	14	13	13	13	13	12	11
3210	-1	12	12	11	9	8	4	0	-1	-5
3220	-11	-15	-18	-22	-25	-25	-24	-22	-21	-21
3230	-21	-21	-21	-21	-21	-21	-21	-20	-19	-19
3240	-20	-21	-22	-22	-22	-22	-26	-24	-20	-16
3250	-13	-10	-6	-1	3	8	11	14	15	17
3260	18	18	16	15	14	13	14	14	14	15
3270	17	17	16	17	17	17	17	17	16	13
3280	11	7	6	6	4	2	1	0	1	5
3290	10	13	16	18	19	20	20	19	18	17
3300	16	15	14	14	16	19	21	23	27	31
3310	34	36	37	37	33	33	29	23	20	16
3320	12	6	1	-1	-4	-7	-8	-6	-5	-5
3330	-5	-5	-5	-4	-3	-3	-4	-7	-8	-11
3340	-14	-16	-14	-15	-16	-16	-16	-12	-8	-6
3350	-5	-2	-1	0	2	4	11	16	23	27
3360	30	36	40	42	45	47	51	53	52	49
3370	46	42	39	34	26	18	12	5	0	-6
3380	-12	-15	-18	-21	-22	-21	-23	-25	-25	-27
3390	-29	-31	-30	-27	-25	-21	-17	-11	-4	0
3400	7	8	11	12	14	14	14	13	11	8
3410	7	9	9	9	7	5	4	2	0	-2
3420	-4	-5	-7	-9	-11	-13	-17	-20	-22	-27
3430	-31	-34	-36	-40	-41	-42	-43	-43	-43	-43
3440	-43	-39	-38	-31	-25	-19	-13	-6	-1	4
3450	3	4	6	7	5	4	4	6	10	13
3460	14	17	20	24	28	33	38	40	41	41
3470	45	44	48	50	51	51	55	60	64	67
3480	69	72	74	77	77	77	74	73	69	63
3490	58	49	44	39	34	32	28	24	22	22
3500	21	19	17	14	11	5	5	-3	-6	-10
3510	-14	-17	-20	-22	-25	-27	-27	-26	-24	-24
3520	-23	-23	-20	-18	-14	-10	-8	-6	-3	-3
3530	-2	-1	1	5	8	13	15	17	19	20
3540	22	23	23	23	22	22	22	21	21	22
3550	24	26	30	32	32	34	35	37	39	39
3560	58	59	59	59	58	56	53	53	55	52
3570	30	28	25	21	17	14	10	3	-6	-14
3580	-20	-26	-28	-28	-31	-33	-33	-33	-33	-33
3590	-47	-48	-48	-48	-48	-48	-48	-48	-48	-48
3600	-17	-14	-10	-7	-5	-4	-1	-2	-2	-2
3610	-2	-2	-1	0	0	5	10	11	13	14
3620	14	17	17	18	20	21	19	19	21	22
3630	21	17	14	14	14	13	12	12	11	11
3640	7	7	6	8	11	11	12	14	16	15
3650	16	20	25	27	30	31	32	31	32	33
3660	30	29	28	26	22	19	17	18	19	19
3670	19	17	16	16	18	17	14	15	15	15
3680	12	9	8	7	3	2	1	2	3	2
3690	1	0	-1	0	2	4	7	10	12	15
3700	18	21	24	27	28	28	28	28	28	28
3710	29	30	31	32	32	32	31	30	29	29
3720	27	26	25	24	22	18	15	14	14	14

TO BE CONTINUED

CONTINUED (S-2113 DOWN)

NO.	(1)	(2)	(3)	(4)	(5)	(6)	(7)	(8)	(9)	(10)
3730	12	12	9	6	3	1	-1	-5	-9	-12
3740	-16	-19	-22	-26	-28	-29	-34	-37	-39	-41
3750	-40	-42	-46	-47	-47	-48	-49	-50	-49	-45
3760	-42	-41	-39	-37	-36	-34	-32	-31	-30	-28
3770	-50	-48	-28	-28	-26	-26	-23	-17	-10	-10
3780	-6	-2	0	0	0	1	1	2	3	3
3790	2	-1	-2	-2	-2	-4	-3	0	4	10
3800	15	20	24	29	32	33	34	35	36	35
3810	34	33	27	22	19	18	18	17	18	19
3820	20	22	22	24	27	30	31	31	31	29
3830	28	25	22	18	16	13	8	1	-5	-11
3840	-14	-18	-22	-24	-25	-25	-27	-29	-29	-28
3850	-8	-25	-21	-19	-19	-18	-15	-11	-7	-4
3860	-3	-1	0	3	5	6	5	4	2	1
3870	1	0	-1	-2	-4	-5	-7	-9	-12	-15
3880	-16	-15	-16	-16	-16	-16	-12	-7	-4	0
3890	5	10	13	15	15	15	18	17	15	12
3900	8	5	3	1	-2	-6	-12	-16	-17	-17
3910	-19	-21	-21	-22	-22	-20	-17	-13	-12	-12
3920	-12	-12	-12	-11	-8	-3	-2	0	3	3
3930	7	8	7	8	7	4	2	0	-2	-5
3940	-9	-12	-12	-11	-13	-16	-16	-14	-13	-10
3950	-5	-2	0	3	5	12	17	21	22	22
3960	22	21	20	19	17	14	12	11	9	6
3970	4	4	6	14	13	13	12	14	14	14
3980	14	14	14	14	13	11	8	6	6	6
3990	6	4	3	2	-5	-8	0	0	-1	-1
4000	-1	-2	-4	-5	-5	-5	-13	-15	-15	-14
4010	-13	-10	-10	-7	-4	-3	-3	-1	-1	0
4020	0	1	2	1	0	0	0	-1	-1	-6
4030	-8	-9	-13	-14	-18	-23	-25	-26	-28	-29
4040	-9	-27	-25	-22	-18	-14	-11	-7	-3	0
4050	1	4	8	12	14	14	14	16	17	17
4060	19	21	19	18	17	14	14	16	17	17
4070	14	16	14	14	14	15	16	16	18	20
4080	22	23	23	23	23	22	22	21	22	21
4090	22	23	23	22	22	22	22	21	19	18
4100	18	17	17	17	19	20	21	23	24	26
4110	27	26	25	24	23	23	23	23	23	24
4120	18	16	14	14	11	8	5	1	-1	-1
4130	-1	0	1	1	1	1	1	2	3	3
4140	2	0	0	0	0	-4	-5	-2	-3	-7
4150	-11	-13	-14	-15	-18	-19	-18	-16	-15	-14
4160	-15	-16	-14	-12	-11	-11	-9	-9	-11	-11
4170	-11	-13	-12	-14	-16	-16	-13	-14	-15	-13
4180	-12	-11	-11	-10	-7	-6	-6	-4	0	-1
4190	-1	-1	-1	-1	0	0	-2	-2	-3	-6
4200	-7	-8	-6	-6	-10	-12	-13	-12	-10	-7
4210	-32	-36	-38	-40	-42	-46	-45	-45	-45	-47
4220	-46	-44	-42	-38	-37	-35	-35	-34	-32	-29
4230	-58	-54	-52	-52	-50	-46	-45	-45	-44	-44
4240	-1	2	7	11	15	18	23	29	34	37
4250	41	46	50	55	58	61	63	66	67	66
4260	65	68	70	69	68	66	65	61	58	53

TO BE CONTINUED

CONTINUED(S-2113 DOWN)

CONTINUED(S-2113 DOWN)

NO.	(1)	(2)	(3)	(4)	(5)	(6)	(7)	(8)	(9)	(10)
4270	45	38	35	33	28	22	17	12	7	2
4280	-1	-5	-10	-14	-15	-18	-22	-25	-27	-28
4290	-29	-30	-32	-33	-36	-37	-38	-44	-43	-44
4300	-44	-44	-46	-42	-38	-35	-33	-29	-26	-23
4310	-18	-13	-9	-6	7	11	14	14	14	14
4320	18	22	26	31	34	37	37	36	36	34
4330	32	31	29	27	23	21	19	18	18	14
4340	12	12	9	8	4	4	3	0	-1	-2
4350	-8	-3	-3	-3	-3	-5	-5	-5	-5	-5
4360	-18	-21	-22	-23	-23	-23	-23	-25	-26	-24
4370	-23	-24	-24	-21	-15	-12	-12	-10	-6	-3
4380	-1	0	0	4	5	6	8	6	4	2
4390	0	0	0	-1	-2	-2	-3	-7	-12	-12
4400	-10	-12	-15	-15	-16	-17	-16	-17	-17	-17
4410	-15	-15	-15	-14	-13	-12	-12	-12	-12	-12
4420	-12	-12	-12	-13	-14	-15	-15	-14	-15	-16
4430	-15	-15	-15	-17	-19	-17	-15	-13	-12	-12
4440	-14	-15	-14	-12	-13	-12	-12	-11	-9	-5
4450	-1	0	2	4	5	6	8	6	4	2
4460	26	27	25	23	25	25	23	21	23	24
4470	14	11	12	11	8	8	9	12	11	12
4480	9	7	6	7	6	4	3	1	2	3
4490	1	-1	-1	-2	-4	-6	-10	-12	-14	-12
4500	-15	-16	-13	-13	-12	-12	-12	-12	-10	-8
4510	-3	-2	0	1	2	5	9	11	11	12
4520	11	12	14	14	14	15	17	17	16	16
4530	15	14	14	14	14	14	14	13	10	5
4540	1	0	-2	-6	-10	-14	-18	-21	-22	-23
4550	-23	-23	-23	-23	-22	-22	-22	-21	-18	-18
4560	-17	-17	-18	-20	-22	-23	-25	-26	-27	-27
4570	-25	-23	-21	-19	-15	-13	-11	-7	-5	-3
4580	-2	-2	-2	-1	0	4	7	9	9	9
4590	9	9	9	10	12	12	12	12	11	10
4600	11	14	14	15	16	17	15	12	11	12
4610	9	5	2	1	-1	-2	-6	-8	-10	-7
4620	-6	-7	-11	-11	-10	-8	-8	-10	-7	-3
4630	-3	-3	-5	-6	-6	-5	-6	-10	-10	-11
4640	-14	-16	-17	-16	-14	-15	-14	-13	-12	-11
4650	-9	-7	-4	-2	-1	0	2	5	9	11
4660	12	12	13	13	13	14	15	16	16	16
4670	14	14	14	12	11	10	7	5	4	3
4680	3	1	0	-1	-1	-2	-2	-3	-3	-2
4690	0	1	2	1	0	1	2	4	6	9
4700	11	13	14	16	16	18	21	22	21	23
4710	25	24	22	22	20	18	17	15	14	14
4720	11	10	9	10	10	9	6	4	4	4
4730	6	7	8	9	9	10	10	10	11	12
4740	12	9	8	7	8	7	5	3	3	3
4750	3	3	2	0	-1	-1	-1	-1	-2	0
4760	-1	-1	-2	-2	-2	-2	-5	-6	-5	-3
4770	-3	-2	-1	-1	0	0	0	2	3	0
4780	-2	-3	-2	-2	-5	-8	-7	-7	-8	-8
4790	-7	-8	-8	-7	-5	-3	-4	-5	-5	-3
4800	0	-1	0	1	0	-1	-1	-1	-2	-4

TO BE CONTINUED

TO BE CONTINUED

CONTINUED(S-2113 DOWN)

NO.	(1)	(2)	(3)	(4)	(5)	(6)	(7)	(8)	(9)	(10)
5350	6	10	12	12	12	12	14	14	14	13
5360	11	10	9	9	5	3	3	1	0	-1
5370	-1	-4	-5	-6	-6	-6	-5	-6	-4	-4
5380	-5	-6	-7	-5	-2	1	3	5	7	8
5390	12	14	15	17	19	19	19	19	16	14
5400	14	15	16	16	16	13	10	10	10	10
5410	11	11	11	10	9	7	7	8	9	10
5420	11	12	10	9	7	10	11	10	9	10
5430	10	8	7	8	6	4	2	1	2	3
5440	4	6	6	7	8	11	12	11	11	10
5450	9	6	5	4	3	2	1	0	0	-1
5460	-4	-7	-7	-7	-10	-17	-18	-21	-23	-26
5470	-28	-30	-31	-33	-35	-35	-33	-36	-38	-38
5480	-37	-38	-38	-38	-36	-36	-35	-34	-36	-33
5490	-28	-26	-24	-22	-22	-22	-18	-16	-13	-11
5500	-8	-7	-6	-5	-5	-5	-6	-6	-5	-5
5510	-5	-5	-6	-9	-11	-11	-12	-13	-14	-18
5520	-21	-23	-23	-24	-25	-25	-26	-26	-26	-26
5530	-24	-23	-22	-20	-18	-17	-17	-15	-14	-12
5540	-12	-10	-8	-8	-7	-3	-2	-1	-1	-1
5550	0	1	3	5	6	5	4	4	4	3
5560	3	3	3	5	5	4	5	6	6	5
5570	5	7	8	8	9	10	11	10	10	10
5580	12	13	12	11	12	13	14	14	13	13
5590	12	14	13	13	13	12	12	13	14	13
5600	12	11	10	9	8	6	5	1	-2	-2
5610	-3	-3	-3	-6	-11	-11	-8	-11	-12	-11
5620	-10	-10	-11	-10	-6	-6	-7	-8	-8	-10
5630	-10	-12	-11	-11	-8	-8	-9	-9	-8	-7
5640	-8	-7	-4	-3	-4	-4	-3	-2	0	1
5650	3	6	10	15	17	17	20	22	24	28
5660	19	28	30	31	33	36	34	32	34	34
5670	36	39	39	38	37	36	34	34	34	33
5680	32	31	29	28	25	22	20	18	16	14
5690	13	11	7	4	2	2	1	1	0	-1
5700	-2	-1	-2	-5	-5	-10	-12	-14	-15	-16
5710	-17	-16	-18	-18	-19	-20	-21	-22	-24	-25
5720	-25	-23	-20	-20	-20	-20	-17	-14	-13	-12
5730	-11	-9	-6	-4	-1	0	2	3	5	8
5740	8	10	12	10	10	12	12	13	14	14
5750	14	14	14	14	16	16	18	17	16	17
5760	16	14	12	12	12	13	12	9	9	9
5770	9	8	8	7	8	7	6	7	7	5
5780	4	4	4	3	4	4	3	2	4	6
5790	7	8	7	8	10	12	13	11	12	11
5800	8	5	2	0	-2	-2	-3	-4	-3	-5
5810	-5	-5	-6	-4	-5	-6	-5	-4	-5	-5
5820	-5	-4	-3	-4	-5	-6	-5	-4	-3	-2
5830	-3	-3	-3	-3	-3	-3	-3	-3	-3	-4
5840	-3	-1	0	0	0	1	3	5	7	5
5850	7	11	12	13	14	14	16	14	16	18
5860	18	18	17	16	17	17	18	19	18	16
5870	15	14	16	17	15	13	12	11	11	11
5880	9	6	5	4	4	2	1	0	-2	-2

TO BE CONTINUED

CONTINUED(S-2113 DOWN)

NO.	(1)	(2)	(3)	(4)	(5)	(6)	(7)	(8)	(9)	(10)
5890	-2	-3	-5	-6	-7	-5	-3	-3	-1	0
5900	2	3	3	6	6	2	8	12	13	13
5910	13	14	14	14	14	16	17	17	17	16
5920	15	14	14	14	14	15	15	14	13	13
5930	14	14	11	9	8	8	9	6	4	1
5940	-2	-4	-5	-6	-7	-9	-10	-12	-14	-16
5950	-18	-18	-20	-23	-24	-26	-28	-30	-33	-33
5960	-32	-33	-35	-33	-33	-33	-32	-30	-29	-30
5970	-29	-27	-25	-23	-20	-18	-16	-14	-11	-9
5980	-6	-5	-4	-2	-1	-2	-2	-2	-1	0
5990	1	0	0	1	1	1	1	0	0	0

END

RECORD = M-1183 COMPONENT = NORTH STATION = YAMASHITA-HEN-M
 DATE AND TIME = 1987-12-17-11-08 TOTAL NUMBER OF DATA = 5950
 SIGNALING INTERVAL = 0.010 (SEC) SCAL = 0.10000
 SIGNAL = GR. ACC.

NO.	(1)	(2)	(3)	(4)	(5)	(6)	(7)	(8)	(9)	(10)	NO.	(1)	(2)	(3)	(4)	(5)	(6)	(7)	(8)	(9)	(10)	
0	-6	21	47	48	25	5	-17	-18	-19	-14	490	84	101	123	132	117	68	-85	-133	-178	-179	
1	4	16	10	-6	-7	-7	5	26	38	41	500	-149	-120	-55	13	52	34	-4	-7	15	57	
2	30	39	52	44	28	12	-11	-24	-33	-42	510	68	54	24	-20	-40	-32	0	5	-6	-36	
3	-34	-19	-19	-18	-19	-18	-19	-18	-19	-14	520	-69	-95	-111	-106	-98	-87	-65	-106	-7	5	
4	2	20	38	40	52	62	60	69	88	95	530	127	87	0	31	98	118	137	143	153	152	
5	75	37	14	-12	-30	-37	-48	-54	-44	-15	540	-127	-129	-118	-89	-36	-75	-87	-93	-103	-116	
6	-10	-39	-65	-63	-40	-10	30	68	93	97	560	40	66	97	127	142	139	98	56	-1	-51	
7	79	91	126	132	120	95	66	37	8	-19	570	-53	-54	-53	-53	-54	-44	-24	-7	4	17	
8	-36	-58	-70	-83	-89	-88	-83	-47	-17	14	580	-51	-44	-66	-87	-88	-88	-76	-47	-29	-9	
9	6	-25	-31	-5	45	84	121	120	88	74	590	-26	-18	-19	-10	0	5	18	38	63	93	
10	84	85	82	65	47	11	-11	-27	-55	-74	600	96	97	83	50	23	-4	-19	-18	-19	-18	
11	-59	-52	-35	-17	-25	-30	-14	-15	-54	-67	610	-23	-31	-39	-43	-37	-30	-34	-59	-77	-77	
12	-60	-29	12	58	81	85	85	79	71	111	620	-66	-34	-7	29	65	74	50	26	8	-3	
13	130	145	147	118	95	84	44	-16	-65	-99	630	-6	-6	-8	1	21	38	53	61	61	22	
14	-84	-66	-64	-66	-63	-73	-99	-109	-101	-68	640	-18	-29	-34	-45	-53	-53	-53	-62	-21	-22	
15	30	13	79	133	188	211	218	202	145	93	650	0	25	50	83	97	96	77	38	17	-6	
16	51	2	-35	-66	-102	-135	-161	-182	-182	-146	660	-21	-34	-47	-54	-64	-88	-99	-107	-112	-111	
17	-126	-118	-84	-64	-73	31	114	195	239	265	670	-103	-97	-78	-54	-17	19	54	71	84	85	
18	256	232	192	155	101	62	6	-55	-124	-183	680	84	85	77	72	73	60	39	-11	-32	-29	
19	-225	-239	-248	-244	-212	-162	-80	-3	78	132	690	-30	-38	-58	-84	-110	-121	-110	-88	-88	-85	
20	171	187	194	196	187	181	161	135	87	36	700	-24	-12	9	33	55	73	91	97	86	92	
21	-25	-95	-162	-205	-232	-239	-238	-231	-200	-123	710	133	131	90	44	8	-37	-74	-109	-121	-96	
22	-141	-49	69	145	192	255	253	258	258	256	720	-58	-19	12	30	16	-17	-7	17	62	117	
23	230	236	182	100	15	-48	-108	-141	-149	-141	730	173	207	203	178	141	102	56	11	-39	-94	
24	-145	-172	-182	-178	-152	-98	-46	-6	22	27	740	55	130	196	246	232	207	162	-104	-47	6	
25	17	20	56	90	97	97	82	51	28	14	760	-33	-32	-29	-15	5	18	-2	-29	38	-30	
26	27	41	48	58	91	107	109	89	45	6	770	-30	-30	-30	-29	-38	-72	-90	-75	-33	-16	
27	-27	-43	-52	-54	-52	-63	-97	-96	-87	-89	780	-8	-7	-51	-83	-122	-146	-162	-25	28	9	
28	-100	-83	-51	-28	-8	11	34	71	105	123	790	4	-7	28	39	38	28	27	26	28	9	
29	131	131	128	114	95	66	42	21	5	-48	800	1	16	-9	-6	39	76	85	83	53	27	
30	-113	-149	-158	-170	-183	-176	-164	-130	-101	-49	810	27	28	35	51	70	75	24	-27	-71	-71	
31	9	62	111	139	153	154	156	166	162	132	820	83	-91	-101	-114	-120	-94	-56	-27	8	60	
32	104	77	42	12	13	34	40	-2	-34	-63	830	106	149	154	152	132	104	57	19	-3	-17	
33	-89	-89	-65	-58	-104	-133	-149	-158	-156	-119	840	-27	-51	-89	-131	-154	-158	-139	-89	-19	36	
34	-59	-27	3	26	45	73	97	127	166	197	850	51	33	26	27	49	76	85	74	55	41	
35	200	201	193	181	163	118	69	17	-37	-63	860	30	24	12	-4	-21	-32	-68	-49	-29	1	
36	-80	-125	-152	-179	-191	-192	-177	-162	-107	-50	870	42	77	107	138	183	228	257	259	249	205	
37	-3	15	0	-3	21	27	26	56	88	64	880	187	115	68	15	-40	-114	-176	-231	-278	208	
38	21	-14	0	59	65	62	52	39	16	-8	890	-88	-288	-237	-143	-19	14	68	131	201	280	
39	21	75	109	88	43	8	-12	-20	-18	-20	900	332	363	376	364	353	366	375	354	304	251	
40	-15	-6	-7	-7	-7	-7	8	23	31	38	910	195	136	89	54	1	-44	-88	-123	-134	-101	
41	31	16	20	-3	-32	-29	-30	-39	-36	-9	920	-42	11	65	93	127	165	188	188	190	170	
42	21	39	37	45	51	41	25	-6	5	25	930	115	46	-14	-14	-137	-188	-204	-230	-265	-279	
43	0	27	21	8	-2	-17	-27	-38	-61	-28	940	-257	-200	-130	-98	-84	-42	-41	-45	-34	-31	
44	62	71	97	107	108	101	89	81	66	61	950	-52	-54	-55	-84	-123	-157	-186	-229	-291	-321	
45	53	56	76	-12	-25	-49	-64	-61	-23	-22	960	-331	-314	-285	-249	-225	-211	-139	-44	40	106	
46	-65	-79	-67	-30	-40	-84	99	84	52	55	970	193	275	337	390	413	429	430	401	386	339	
47	89	119	101	65	40	12	-20	-31	-21	-12	980	280	238	204	189	176	165	165	173	198	226	
48	-27	-58	-99	-124	-119	-68	-2	31	54	72	990	255	274	296	298	249	187	96	8	-72	-176	
											1000	-263	-321	-321	-321	-321	-321	-321	-321	-321	-321	-321
											1010	-551	-585	-585	-585	-585	-585	-585	-585	-585	-585	-585
											1020	251	314	360	402	409	403	376	351	303	237	237

TO BE CONTINUED

CONTINUED (M-1183 NORTH)

CONTINUED (M-1183 NORTH)

	(1)	(2)	(3)	(4)	(5)	(6)	(7)	(8)	(9)	(10)
1030	150	37	-100	-226	-339	-430	-501	-555	-568	-574
1040	-573	-568	-526	-459	-376	-289	-203	-142	-91	-64
1050	-4	-18	0	58	120	206	302	383	484	570
1060	569	634	666	670	596	503	353	200	47	596
1070	-116	-357	-561	-744	-895	-981	-1014	-1026	-1022	-939
1080	-620	-622	-755	-590	-437	-331	-116	42	238	488
1090	674	907	1167	1281	1363	1401	1402	1330	1250	1047
1100	756	534	293	128	-106	-389	-617	-860	-1012	-1109
1110	-1155	-1164	-1141	-1076	-1000	-936	-867	-756	-651	-500
1120	-356	-235	-119	-42	36	110	181	190	189	171
1130	196	249	306	356	410	454	495	539	585	612
1140	617	615	605	547	441	344	260	246	245	245
1150	248	230	146	29	-71	-171	-346	-524	-670	-722
1160	-174	-779	-780	-687	-576	-489	-372	-207	-56	65
1170	212	323	416	467	501	509	473	467	485	491
1180	440	376	286	185	109	-205	-253	-261	-165	-109
1190	-22	58	199	306	302	230	181	134	100	82
1200	61	18	-20	-33	-2	47	105	173	218	244
1210	252	245	197	135	33	-60	-118	-155	-190	-220
1220	-235	-239	-235	-209	-168	-136	-127	-131	-161	-192
1230	-179	-134	-49	74	179	223	235	202	135	111
1240	61	16	-31	-81	-104	-69	-5	-15	-71	-113
1250	-123	-146	-187	-202	-192	-197	-228	-249	-214	-167
1260	-133	-126	-117	-118	-182	-232	-251	-249	-250	-223
1270	-184	-143	-101	-56	6	81	174	274	345	406
1280	662	478	489	510	545	569	542	469	349	278
1290	139	21	-99	-178	-273	-393	-528	-647	-701	-729
1300	-112	-658	-580	-457	-333	-140	20	167	344	405
1310	452	439	383	297	208	120	7	-131	-226	-318
1320	-186	-365	-310	-220	-169	-117	-111	-130	-164	-188
1330	-186	-131	-56	-17	15	36	45	69	114	181
1340	265	365	467	587	624	609	540	453	380	340
1350	340	346	354	340	322	196	89	-16	-133	-204
1360	-231	-254	-281	-303	-326	-362	-398	-411	-410	-375
1370	-307	-207	-75	51	165	296	418	495	545	560
1380	531	462	344	133	-9	-40	-42	-84	-147	-207
1390	-283	-364	-514	-579	-647	-710	-708	-630	-412	-188
1400	-254	-85	86	223	303	341	363	317	255	211
1410	151	72	47	30	27	20	33	30	34	50
1420	99	143	156	131	83	72	90	153	190	182
1430	131	87	49	-2	-94	-211	-221	-192	-192	-195
1440	-217	-229	-215	-166	-111	-47	0	99	167	177
1450	136	71	20	-45	-121	-138	-116	-72	-121	3
1460	41	77	85	80	64	41	38	40	61	97
1470	136	166	196	220	245	233	213	228	256	268
1480	280	282	255	223	180	144	107	79	72	73
1490	73	65	31	2	-33	-44	-32	-24	-44	-82
1500	-77	-61	-75	-97	-145	-208	-274	-350	-396	-412
1510	-394	-361	-315	-265	-224	-218	-228	-220	-158	-70
1520	19	202	322	360	344	317	268	202	126	64
1530	1	-61	-113	-137	-133	-101	-32	29	84	155
1540	238	315	380	445	493	500	476	468	415	395
1550	356	321	274	186	24	-135	-291	-419	-499	-565
1560	-569	-509	-416	-313	-203	-110	-49	4	30	40

TO BE CONTINUED

TO BE CONTINUED

NO.	(1)	(2)	(3)	(4)	(5)	(6)	(7)	(8)	(9)	(10)
2110	-276	-285	-275	-220	-170	-120	-31	64	126	180
2120	209	195	178	132	69	12	-36	-65	-83	-94
2130	-103	-118	-141	-164	-169	-155	-139	-119	-91	-44
2140	-3	34	76	99	114	120	109	93	77	63
2150	61	88	127	175	215	212	210	204	187	149
2160	77	9	-101	-170	-190	-193	-191	-174	-139	-94
2170	-38	17	170	97	84	39	-18	-89	-146	-192
2180	-225	-240	-227	-180	-126	-91	-75	-85	-118	-125
2190	-113	-87	-50	-30	-31	-27	-3	35	70	70
2200	96	105	84	45	8	-32	-59	-73	-77	-66
2210	-59	-29	16	28	26	27	26	27	26	31
2220	56	93	129	143	141	130	110	96	96	95
2230	121	169	213	239	255	242	215	184	158	138
2240	127	87	51	16	17	50	84	-112	-137	-146
2250	-146	-136	-116	-111	-111	-123	-119	-112	-78	-41
2260	-20	4	26	49	76	107	134	163	194	209
2270	227	248	269	288	309	317	313	287	236	189
2280	135	71	12	-45	-48	-55	-50	-39	-19	5
2290	16	13	-14	-42	-45	-82	-127	-159	-188	-214
2300	-227	-227	-217	-201	-188	-180	-180	-180	-186	-200
2310	-204	-212	-217	-208	-191	-151	-99	-44	5	40
2320	63	80	85	84	84	84	75	59	41	19
2330	4	-12	-20	-12	0	17	34	52	75	103
2340	132	142	142	131	107	83	57	50	49	86
2350	129	158	202	212	212	208	190	156	117	83
2360	57	35	11	-9	-19	-18	-19	-7	6	15
2370	8	-16	-47	-90	-137	-183	-229	-265	-300	-333
2380	-351	-355	-334	-294	-255	-185	-115	-51	35	117
2390	191	228	253	259	255	245	223	201	192	195
2400	195	172	137	80	42	4	-28	-47	-67	-87
2410	-111	-129	-148	-175	-195	-213	-229	-245	-251	-250
2420	-245	-217	-181	-140	-99	-61	-25	2	31	62
2430	97	122	131	130	131	127	118	119	119	128
2440	140	160	189	210	226	241	253	259	257	258
2450	252	239	207	171	141	100	50	-12	-86	-157
2460	-224	-300	-349	-366	-386	-388	-390	-385	-370	-330
2470	-255	-192	-139	-112	-95	-88	-87	-95	-102	-113
2480	-122	-127	-135	-138	-147	-135	-112	-63	-9	45
2490	95	146	198	244	294	330	340	337	324	296
2500	266	239	204	184	158	129	83	65	3	26
2510	-30	-32	-21	6	38	77	106	135	164	178
2520	174	153	126	96	73	56	49	50	50	42
2530	25	11	-1	-12	-28	-41	-57	-68	-78	-91
2540	-160	-100	-100	-100	-100	-99	-100	-99	-103	-113
2550	-143	-183	-230	-270	-302	-332	-342	-343	-332	-291
2560	-206	-124	-62	-3	46	89	126	144	142	138
2570	118	97	71	63	76	95	120	150	181	206
2580	225	246	265	269	269	269	270	266	247	225
2590	200	167	123	90	53	13	-20	-57	-75	-76
2600	-76	-62	-53	-48	-32	-44	-60	-77	-105	-130
2610	-145	-163	-180	-195	-212	-230	-249	-263	-274	-284
2620	-265	-285	-285	-285	-285	-284	-266	-242	-209	-163
2630	-121	-81	-43	-8	11	16	14	0	-21	-37
2640	-47	-54	-66	-66	-64	-57	-45	-26	-6	17

TO BE CONTINUED

TO BE CONTINUED

NO.	(1)	(2)	(3)	(4)	(5)	(6)	(7)	(8)	(9)	(10)
3190	38	61	84	108	131	151	160	160	160	159
3200	144	113	83	49	12	-25	-53	-71	-92	-109
3210	-124	-128	-130	-110	-68	-40	-7	21	54	88
3220	116	151	190	217	226	231	222	208	182	161
3230	142	118	95	71	50	31	14	9	10	0
3240	-1	-10	-13	-13	2	33	67	105	133	153
3250	160	159	160	150	139	126	104	68	19	-16
3260	-46	-78	-107	-124	-129	-128	-129	-125	-109	-101
3270	-85	-62	-29	-74	25	128	92	133	163	182
3280	193	193	181	168	151	125	94	65	24	-8
3290	-48	-88	-108	-116	-119	-129	-128	-129	-127	-136
3300	-130	-106	-85	-46	-13	3	17	29	34	25
3310	1	-21	-21	-63	-79	-82	-62	-77	-54	-28
3320	-23	-35	-46	-60	-73	-85	-94	-93	-82	-82
3330	-72	-65	-58	-60	-56	-62	-30	-23	-25	-19
3340	-7	6	15	31	46	62	69	64	54	38
3350	32	20	0	-1	-2	0	-7	-13	-12	-12
3360	-13	-81	-12	-13	-10	0	-2	3	22	45
3370	66	81	103	116	123	136	148	156	167	195
3380	207	205	207	203	188	170	147	130	121	112
3390	103	90	71	59	49	34	18	6	6	-3
3400	-19	-27	-34	-40	-48	-47	-47	-33	-17	8
3410	40	69	86	91	84	71	57	37	22	22
3420	-19	-32	-46	-48	-40	-15	5	24	50	80
3430	112	159	145	149	147	135	119	94	70	46
3440	19	-12	-44	-82	-119	-143	-160	-163	-159	-129
3450	-94	-58	-22	3	33	54	63	68	55	35
3460	11	-16	-40	-64	-88	-90	-72	-60	-58	-64
3470	-71	-70	-64	-53	-32	-3	19	32	35	35
3480	28	15	5	-11	-22	-30	-37	-35	-36	-36
3490	-55	-25	-9	7	10	10	9	10	9	12
3500	22	31	33	32	33	33	33	33	32	33
3510	30	15	0	-17	-37	-67	-98	-123	-136	-146
3520	-151	-140	-139	-126	-110	-88	-58	-24	8	39
3530	69	102	128	148	157	160	145	135	121	100
3540	80	56	37	27	17	9	10	9	19	40
3550	63	86	110	129	146	151	140	130	123	114
3560	113	114	104	93	84	68	68	66	81	93
3570	102	96	77	49	24	-3	-23	-30	-44	-48
3580	-56	-63	-73	-82	-91	-95	-92	-98	-106	-105
3590	-105	-105	-103	-93	-94	-93	-100	-113	-128	-148
3600	-173	-193	-203	-209	-198	-173	-158	-101	-93	-84
3610	-81	-81	-61	-52	-39	13	51	53	68	84
3620	91	89	74	62	53	44	44	56	73	96
3630	128	153	163	172	166	157	140	124	112	105
3640	79	57	53	45	39	32	23	3	-6	-19
3650	-41	-77	-110	-125	-130	-138	-140	-139	-140	-132
3660	-120	-108	-89	-68	-30	0	19	32	33	33
3670	33	33	25	11	10	4	-2	0	8	10
3680	8	16	22	22	32	38	51	59	69	79
3690	90	99	103	102	102	93	81	70	65	57
3700	50	37	32	23	3	-12	-27	-42	-60	-84
3710	-104	-120	-132	-150	-164	-150	-123	-64	-41	-7
3720	-27	52	65	79	99	107	114	114	110	101

TO BE CONTINUED

TO BE CONTINUED

NO.	(1)	(2)	(3)	(4)	(5)	(6)	(7)	(8)	(9)	(10)
4270	16	-6	-21	-25	-24	-25	-23	-30	-37	-35
4280	-36	-35	-36	-36	-36	-36	-35	-36	-35	-35
4290	-29	-24	-19	-4	10	22	20	22	21	14
4300	-2	-18	-31	-35	-42	-48	-52	-69	-84	-95
4310	-93	-94	-95	-95	-87	-81	-73	-53	-35	-19
4320	-1	-2	-2	9	13	21	27	35	44	44
4330	44	51	57	64	77	80	66	45	31	31
4340	34	-5	-8	0	-2	0	0	-11	-13	-13
4350	-12	-13	-12	-13	-12	-14	-6	-6	0	0
4360	-2	33	12	21	31	33	32	33	33	33
4370	35	35	35	32	33	31	21	21	21	15
4380	22	16	9	10	10	3	-6	-13	-15	-13
4390	-13	-12	-19	-32	-43	-56	-66	-76	-72	-86
4400	-112	-116	-117	-106	-105	-98	-88	-104	-106	-97
4410	-70	-68	-72	-88	-93	-98	-106	-104	-64	85
4420	-85	-74	-54	-34	-14	3	20	43	64	85
4430	99	110	125	138	136	135	119	113	98	86
4440	59	58	32	18	5	-8	-13	-21	-25	-24
4450	-24	-24	-16	-11	6	16	23	32	35	33
4460	32	33	32	32	18	1	-11	-24	-38	-48
4470	-47	-47	-47	-53	-61	-54	-48	-43	-36	-36
4480	-29	-24	-21	-11	-14	-12	-14	-6	0	-1
4490	0	10	3	-2	-1	-2	-11	-12	-5	-5
4500	0	0	0	9	27	34	33	34	34	34
4510	34	34	34	33	34	35	41	52	65	78
4520	88	91	96	104	103	100	89	79	57	32
4530	12	-4	-19	-24	-32	-47	-60	-69	-70	-70
4540	-68	-74	-83	-94	-104	-111	-127	-126	-132	-139
4550	-141	-150	-152	-162	-162	-155	-144	-138	-139	-139
4560	-138	-129	-119	-100	-75	-47	-29	-15	-9	1
4570	19	22	23	14	11	5	0	-7	-13	-11
4580	-11	-19	-26	-37	-48	-64	-69	-75	-81	-82
4590	-67	-55	-48	-45	-33	-22	-23	-23	-13	-13
4600	-3	0	0	0	0	0	0	-1	2	11
4610	13	26	34	42	49	57	57	57	48	48
4620	45	40	27	19	7	-3	-18	-24	-22	-24
4630	-21	-13	-4	0	5	12	20	37	51	64
4640	69	68	69	67	57	48	42	30	20	20
4650	11	1	-2	-12	-24	-35	-49	-65	-76	-91
4660	-92	-93	-90	-82	-70	-58	-48	-30	-16	-4
4670	13	37	59	78	92	91	82	81	60	40
4680	13	-7	-27	-45	-57	-74	-94	-103	-111	-116
4690	-115	-112	-100	-93	-68	-45	-30	-11	7	32
4700	54	79	92	101	104	103	103	101	87	75
4710	61	49	30	9	-4	-20	-23	-22	-6	0
4720	7	12	10	10	10	0	-2	-12	-11	-20
4730	-23	0	0	2	11	10	11	10	10	0
4740	0	0	0	2	11	10	11	10	10	0
4750	0	-8	-15	-23	-23	-23	-23	-24	-18	-8
4760	2	11	10	11	11	3	5	12	12	0
4770	-23	-23	-24	-34	-35	-32	-21	-13	-5	0
4780	-23	-26	-36	-34	-33	-34	-25	-19	4	4
4790	7	18	24	33	34	33	34	25	19	4
4800	-9	-21	-23	-32	-35	-34	-35	-35	-35	-35

TO BE CONTINUED

TO BE CONTINUED

CONTINUED (M-1183 NORTH)

NO.	(1)	(2)	(3)	(4)	(5)	(6)	(7)	(8)	(9)	(10)
5350	34	43	51	58	56	57	57	56	47	45
5360	46	43	33	34	33	34	33	34	33	35
5370	28	21	22	11	11	11	11	11	10	11
5380	21	22	22	23	20	5	-9	-20	-29	-23
5390	-56	-69	-77	-84	-96	-105	-104	-104	-103	-105
5400	-95	-91	-94	-80	-59	-44	-28	-13	2	14
5410	28	45	51	65	81	93	90	98	104	103
5420	112	116	104	91	74	49	45	45	45	57
5430	46	44	44	58	56	57	57	57	57	57
5440	47	45	46	42	21	11	-2	-24	-38	-54
5450	-69	-69	-79	-81	-81	-80	-82	-73	-60	-51
5460	-45	-47	-46	-46	-47	-45	-51	-59	-58	-58
5470	-58	-50	-45	-47	-46	-46	-46	-46	-46	-46
5480	-46	-46	-46	-46	-36	-24	-12	-2	14	35
5490	52	65	69	68	69	61	56	47	44	36
5500	26	17	5	-1	0	0	0	0	0	0
5510	0	0	0	0	0	0	0	0	-1	4
5520	12	9	19	23	22	22	22	22	22	22
5530	23	14	10	11	10	11	10	14	23	23
5540	38	45	54	57	57	57	57	57	57	49
5550	39	30	21	12	2	0	0	0	0	0
5560	-14	-24	-31	-36	-34	-36	-25	-23	-20	-11
5570	-12	-12	-23	-23	-23	-23	-24	-17	-11	-11
5580	-12	-11	-12	-11	-12	-11	-12	-5	0	-1
5590	0	0	0	-1	5	13	5	0	-4	-12
5600	-15	-24	-22	-24	-23	-23	-23	-23	-23	-23
5610	-22	-24	-18	-11	-5	2	10	11	10	11
5620	10	11	4	-8	-12	-11	-22	-23	-23	-23
5630	-24	-16	-9	0	0	0	0	0	-1	6
5640	16	37	53	61	74	88	93	86	79	79
5650	63	55	48	40	33	24	22	22	22	22
5660	22	22	22	22	12	3	-6	-12	-11	-12
5670	-3	0	0	0	0	-1	5	11	11	20
5680	28	34	38	47	40	28	18	11	10	11
5690	21	23	22	23	19	10	11	10	11	10
5700	11	10	11	10	11	10	12	4	0	-5
5710	-14	-22	-23	-23	-23	-23	-22	-24	-16	-12
5720	-8	0	2	11	13	23	22	34	32	41
5730	45	51	58	56	58	56	58	47	31	15
5740	1	-10	-27	-38	-49	-56	-64	-71	-68	-76
5750	-82	-88	-88	-94	-91	-81	-81	-72	-67	-58
5760	-48	-40	-39	-24	-15	-12	-7	0	6	11
5770	14	23	25	36	16	9	12	24	35	46
5780	44	50	58	56	57	57	53	40	27	14
5790	0	0	0	0	0	-1	2	10	15	23
5800	34	35	46	44	53	58	57	57	57	57
5810	57	57	58	52	40	28	21	23	22	22
5820	22	22	22	22	22	22	22	23	34	34
5830	34	33	36	46	46	45	45	45	45	45
5840	45	45	45	45	45	45	45	45	44	35
5850	31	18	11	8	-1	-10	-12	-11	-12	-10
5860	-1	0	10	10	10	11	10	11	10	-1
5870	4	18	20	9	12	9	1	-4	-12	-11
5880	-12	-11	-11	-12	-11	-12	-10	-18	-23	-29

TO BE CONTINUED

CONTINUED (M-1183 NORTH)

NO.	(1)	(2)	(3)	(4)	(5)	(6)	(7)	(8)	(9)	(10)
5890	-36	-33	-41	-47	-45	-50	-58	-58	-57	-59
5900	-51	-45	-47	-46	-46	-46	-45	-53	-59	-57
5910	-58	-58	-58	-58	-57	-58	-48	-46	-47	-47
5920	-59	-35	-31	-22	-23	-26	-38	-44	-54	-57
5930	-62	-70	-73	-82	-80	-82	-80	-91	-92	-93
5940	-88	-79	-65	-56	-59	-53	-42	-26	-23	-23

END

RECORD = M-1183 COMPONENT = EAST STATION = YAMASHITA-HEN-H
 DATE AND TIME = 1987-12-17-11-08 TOTAL NUMBER OF DATA = 5950
 SAMPLING INTERVAL = 0.010 (SEC) SCAL = 0.10000
 SIGNAL = GR. ACC.

NO.	(1)	(2)	(3)	(4)	(5)	(6)	(7)	(8)	(9)	(10)
0	51	105	85	68	33	8	-4	-4	-2	7
10	7	0	-38	-76	-92	-91	-68	-59	-18	-14
20	-15	-16	-28	-38	-24	4	33	51	52	50
30	35	27	9	-10	-25	-36	-37	-38	-22	11
40	33	40	33	-22	31	22	31	24	24	10
50	-53	-59	-36	6	34	40	18	-9	-44	-56
60	-27	26	85	119	127	102	69	32	0	-1
70	7	5	-15	-48	-70	-76	-47	-27	-16	-16
80	-14	-23	-27	-23	-12	5	18	18	18	18
90	27	44	51	33	-7	-38	-53	-62	-51	-24
100	16	47	52	38	2	-17	-4	26	57	56
110	32	0	-24	-36	-39	-30	-16	-26	-26	-26
120	-26	-26	-26	-21	-4	9	-6	-15	-4	58
130	74	75	86	51	51	55	64	59	37	-15
140	-60	-99	-116	-109	-88	-75	-75	-71	-71	-72
150	-92	-9	46	104	162	185	188	176	143	98
160	14	-34	-71	-109	-121	-125	-108	-104	-112	-117
170	-115	-113	-62	-11	14	38	69	127	183	197
180	179	144	104	49	-12	-67	-98	-107	-117	-125
190	-117	-86	-36	17	72	107	121	112	80	74
200	74	74	76	59	-1	-75	-162	-214	-388	-388
210	-237	-197	-148	-92	-49	-28	-14	6	35	68
220	92	110	120	129	127	199	76	76	87	62
230	16	-44	-92	-101	-106	-104	-105	-93	-95	-90
240	-82	-60	-33	-2	29	52	51	49	19	-4
250	-3	-4	-5	-14	-23	-28	-36	-38	-34	-25
260	-27	-26	-13	30	53	52	40	21	-13	-37
270	-37	-36	-26	-26	-26	-26	-26	-26	-26	4
280	32	62	81	25	-15	-28	-22	-6	8	35
290	50	52	58	41	-21	-63	-75	-83	-83	-79
300	-64	-47	-29	-10	-4	8	26	36	51	52
310	70	78	60	38	15	-10	-41	-59	-90	-106
320	-103	-90	-68	-41	-11	7	35	65	53	50
330	55	53	-9	-22	-36	-42	-63	-87	-94	-94
340	-92	-96	-72	-1	30	77	103	94	82	107
350	119	108	61	-5	-37	-91	-93	-90	-56	-35
360	-45	-76	-94	-73	-12	48	101	141	154	138
370	85	29	3	-2	19	-72	-127	-188	-226	-255
380	-248	-198	-139	-94	-78	-70	-51	-16	28	91
390	153	196	228	224	192	128	69	23	-24	-74
400	-107	-117	-110	-85	-59	-48	-35	-10	24	51
410	65	80	88	67	41	14	-24	-56	-71	-72
420	-69	-61	-54	-97	-130	-123	-100	-52	14	67
430	82	44	-10	-53	-71	-70	-25	41	80	83
440	42	4	-3	22	69	94	91	62	3	-43
450	-52	-69	-3	39	52	51	31	0	-23	-25
460	-14	-2	6	18	30	29	19	3	-41	-41
470	-78	-121	-125	-91	-65	17	83	102	123	120
480	81	74	85	99	75	24	-40	-112	-176	-193

TO BE CONTINUED

CONTINUED (M-1183 EAST)

NO.	(1)	(2)	(3)	(4)	(5)	(6)	(7)	(8)	(9)	(10)
1030	215	229	214	186	191	220	252	276	286	252
1040	203	132	11	-167	-252	-293	-315	-529	-369	-417
1050	-446	-466	-471	-448	-354	-289	-222	-143	-94	-49
1060	-10	53	124	211	337	402	440	475	502	533
1070	591	638	697	735	738	734	665	508	406	156
1080	-86	-193	-289	-349	-398	-440	-493	-544	-586	-640
1090	-700	-772	-838	-861	-849	-733	-647	-558	-503	-446
1100	-393	-368	-353	-311	-272	-242	-231	-227	-258	-282
1110	-256	-187	-47	76	178	257	336	364	392	439
1120	517	625	719	777	798	798	766	638	505	256
1130	92	10	-89	-147	-216	-297	-401	-527	-662	-731
1140	-785	-799	-743	-666	-548	-390	-198	-64	82	224
1150	350	374	344	292	222	78	-45	-115	-180	-214
1160	-24	-176	-73	39	149	200	234	251	244	196
1170	151	76	22	-44	-109	-161	-215	-277	-350	-408
1180	-421	-414	-365	-250	-103	114	415	616	684	702
1190	681	604	446	363	325	299	266	172	52	-191
1200	-376	-377	-462	-526	-576	-582	-535	-490	-466	-441
1210	-411	-392	-346	-280	-177	-72	-20	18	50	74
1220	107	161	200	242	288	309	307	282	262	280
1230	353	373	374	354	292	166	-6	-139	-211	-258
1240	-272	-255	-24	-184	-95	-19	60	123	189	227
1250	228	204	52	125	191	-206	-202	-190	-169	-160
1260	-161	-172	-186	-159	-88	-22	37	96	123	133
1270	110	66	-46	-144	-179	-176	-149	-97	-41	31
1280	102	186	296	426	572	659	730	775	800	801
1290	672	556	401	190	59	-91	235	-353	-643	-557
1300	-642	-684	-687	-698	-630	-511	-427	-335	-227	-174
1310	-146	-159	-123	-115	-116	-116	-116	-138	-154	-139
1320	-98	0	105	181	232	229	196	103	48	3
1330	-5	-1	18	39	39	30	17	27	28	42
1340	83	122	149	164	145	114	87	34	-30	-111
1350	-169	-207	-246	-286	-326	-348	-356	-309	-221	-145
1360	-86	-37	-8	8	47	63	111	174	214	220
1370	206	183	136	73	-46	-156	-169	-171	-156	-140
1380	-109	-92	-100	-94	-62	-21	34	82	103	109
1390	88	-32	-147	-206	-240	-198	-122	-31	44	134
1400	238	290	273	235	225	236	206	145	62	-6
1410	-78	-165	-252	-350	-381	-379	-340	-291	-225	-153
1420	-76	30	138	231	346	421	484	506	481	386
1430	268	187	100	55	77	123	143	114	42	41
1440	-113	-91	-61	56	121	191	224	233	217	155
1450	99	47	8	-87	-62	-90	-94	-94	-86	-69
1460	-52	-55	-77	-93	-102	-117	-130	-166	-205	-273
1470	-346	-402	-453	-467	-477	-466	-441	-410	-380	-337
1480	-279	-187	-94	-27	68	95	85	55	-2	-26
1490	-24	16	125	257	294	312	338	374	429	429
1500	440	482	525	531	501	396	147	423	-64	-184
1510	-269	-353	-424	-514	-602	-651	-662	-595	-470	-363
1520	-229	-44	139	241	292	318	335	345	355	362
1530	362	340	306	258	164	69	-47	-157	-233	-290
1540	316	-336	-348	-355	-361	-368	-377	-385	-393	-378
1550	-340	-370	-191	-81	47	116	155	172	178	136
1560	103	96	80	65	42	19	-21	-73	-118	-173

TO BE CONTINUED

CONTINUED (M-1183 EAST)

NO.	(1)	(2)	(3)	(4)	(5)	(6)	(7)	(8)	(9)	(10)
1570	-210	-238	-244	-254	-249	-230	-186	-149	-109	-64
1580	-23	34	77	134	181	205	224	237	238	227
1590	209	184	161	133	116	93	74	64	58	58
1600	73	101	129	174	212	255	309	348	351	318
1610	259	207	151	105	53	15	14	13	13	-5
1620	-36	-64	-106	-162	-187	-189	-162	-125	-121	-120
1630	-122	-114	-98	-98	-83	-67	-48	-20	4	21
1640	24	26	11	-34	-72	-103	-122	-141	-138	-108
1650	-51	0	30	38	17	-31	-71	-76	-75	-76
1660	-74	-79	-95	-131	-175	-193	-193	-149	-116	-69
1670	29	124	219	300	359	392	434	466	486	470
1680	390	292	209	129	80	16	-24	-45	-58	-79
1690	-87	-86	-87	-81	-58	-35	-21	-21	-40	-60
1700	-91	-123	-148	-168	-178	-178	-160	-117	-57	-216
1710	18	114	233	305	354	379	352	314	253	134
1720	29	-110	-195	-311	-436	-505	-583	-592	-575	-522
1730	-441	-333	-239	-105	-17	103	205	236	256	282
1740	280	242	183	114	42	26	95	173	273	331
1750	-398	-422	-435	-420	-401	-370	-353	-299	-229	-187
1760	-132	-69	19	112	203	277	332	362	385	408
1770	429	440	437	413	354	270	179	116	64	23
1780	-16	-66	-121	-187	-233	-252	-257	-250	-239	-216
1790	-174	-140	-93	-42	10	76	150	217	270	319
1800	347	350	321	284	270	254	248	234	198	141
1810	63	-28	-100	-167	-158	-166	-147	-111	-75	-38
1820	6	19	31	36	36	35	15	-17	-45	-140
1830	-234	-314	-416	-478	-509	-521	-526	-525	-519	-507
1840	-489	-453	-415	-372	-317	-262	-201	-145	-64	-32
1850	23	89	167	212	274	337	387	428	456	496
1860	511	516	496	462	418	375	309	228	155	81
1870	7	-40	-88	-134	-176	-199	-199	-200	-187	-151
1880	-90	-3	32	36	36	34	25	24	31	50
1890	73	95	123	156	188	219	237	250	249	250
1900	249	229	204	175	141	100	51	12	-29	-62
1910	-110	-138	-179	-221	-255	-292	-311	-318	-325	-310
1920	-286	-263	-232	-204	-189	-188	-188	-188	-188	-177
1930	-177	-159	-121	-92	-63	-51	-30	-15	11	45
1940	48	33	10	-5	-9	-8	7	26	22	8
1950	-20	-42	-61	-41	-22	16	64	124	177	212
1960	212	206	193	163	142	109	77	48	2	-43
1970	-91	-135	-171	-198	-202	-200	-134	-90	-46	3
1980	63	118	171	213	228	227	224	192	116	39
1990	-2	-26	-52	-86	-112	-141	-169	-197	-231	-255
2000	-270	-288	-286	-251	-206	-161	-106	-67	-27	15
2010	12	-12	-19	-7	11	65	105	137	160	164
2020	140	124	134	169	207	225	234	220	199	162
2030	153	119	113	116	123	131	127	100	81	82
2040	79	93	122	146	161	125	55	-1	-62	-116
2050	-141	-145	-130	-87	-40	-15	-11	-18	-27	-31
2060	-40	-42	-44	-53	-55	-65	-64	-74	-83	-92
2070	-99	-99	-101	-107	-94	-62	-25	12	25	24
2080	9	-25	-48	-68	-97	-117	-129	-132	-131	-131
2090	-120	-87	-41	-20	-19	-21	-36	-56	-63	-45
2100	-7	47	100	157	206	216	216	195	145	99

TO BE CONTINUED

NO.	(1)	(2)	(3)	(4)	(5)	(6)	(7)	(8)	(9)	(10)	(1)	(2)	(3)	(4)	(5)	(6)	(7)	(8)	(9)	(10)	
2110	70	38	-3	-19	-20	-13	-7	-8	-8	-7	2650	68	128	209	277	318	340	352	340	315	277
2120	-12	-19	-8	9	41	70	101	126	151	173	2660	199	121	70	29	-8	-38	-70	-118	-143	-142
2130	186	192	180	138	85	47	15	13	16	31	2670	-144	-131	-71	-17	24	58	100	127	142	159
2140	57	85	101	105	99	77	52	38	31	17	2680	169	171	159	142	105	66	31	-2	-35	-55
2150	14	4	3	-3	-9	-8	-5	6	17	25	2690	-54	-30	-30	-31	-29	-44	-54	-54	-53	-49
2160	24	25	16	10	-1	-11	-18	-24	-31	-40	2700	-37	-21	-25	-53	-70	-86	-73	108	11	42
2170	-55	-64	-84	-99	-107	-111	-102	-78	-52	-62	2710	60	79	81	81	80	86	100	108	104	83
2180	-36	-25	-20	-15	-7	-9	-8	-17	-21	-21	2720	49	20	-6	-28	-44	-53	-61	-66	-55	-40
2190	-31	-30	-34	-44	-33	-14	16	51	73	82	2730	-85	-19	-20	-19	-18	8	40	59	74	77
2200	90	93	92	92	92	78	54	32	-8	-69	2740	57	23	-5	-32	-50	-56	-71	-93	-115	-130
2210	-67	-82	-87	-87	-86	-87	-86	-94	-99	-96	2750	-132	-132	-129	-100	-56	19	4	34	51	73
2220	-64	-23	0	24	44	67	87	106	137	175	2760	85	91	77	59	28	2	2	-43	-93	-125
2230	218	239	236	223	195	162	116	79	53	54	2770	-150	-154	-154	-149	-132	-108	-78	-63	-4	33
2240	73	78	54	29	0	-19	-54	-45	-70	-102	2780	65	84	100	115	96	83	74	67	59	59
2250	-124	-171	-220	-244	-257	-252	-240	-212	-183	-150	2790	73	91	114	109	99	82	88	113	135	135
2260	132	-127	-119	-121	-107	-92	-66	-32	24	85	2800	160	166	206	213	182	150	105	73	59	58
2270	133	171	191	194	192	182	170	174	182	191	2810	65	80	78	63	40	11	-16	-20	-6	7
2280	207	201	157	95	58	37	36	35	41	54	2820	25	36	35	36	34	23	13	4	-8	-18
2290	76	98	116	128	137	151	166	181	182	183	2830	-50	-78	-98	-98	-106	-108	-96	-79	-53	-41
2300	169	135	88	39	2	-50	-70	-97	-113	-121	2840	-42	-44	-68	-103	-127	-133	-131	-130	-115	-102
2310	-120	-121	-110	-97	-87	-90	-111	-137	-144	-142	2850	-90	-86	-91	-111	-138	-139	-128	-111	-108	-96
2320	-144	-142	-144	-141	-133	-128	-120	-121	-120	-112	2860	-72	-53	-54	-72	-96	-111	-120	-110	-89	-58
2330	105	-94	-78	-57	-43	-41	-45	-74	-112	-140	2870	-38	28	28	51	81	101	120	132	137	124
2340	-162	-175	-187	-188	-188	-175	-151	-135	-122	-116	2880	111	102	74	51	34	22	31	44	58	81
2350	-107	-97	-84	-54	-33	-20	-35	-43	-35	-16	2890	99	99	99	47	-6	-33	-61	-87	-122	-147
2360	7	37	48	47	44	29	30	46	55	68	2900	-140	-188	-206	-221	-187	-135	-103	-64	-25	5
2370	74	84	96	104	53	10	-23	-68	-60	-80	2910	30	46	47	47	45	27	3	-19	-40	-55
2380	-95	-106	-111	-103	-88	-72	-51	-37	-22	-8	2920	-64	-79	-87	-87	-85	-57	-39	-18	-4	9
2390	1	7	23	36	46	47	47	47	47	55	2930	32	44	55	76	85	93	92	92	91	81
2400	75	82	80	81	81	81	81	81	80	86	2940	82	75	68	72	80	84	100	120	119	89
2410	101	111	125	119	92	55	36	38	56	78	2950	52	20	-1	-19	-38	-42	-42	-42	-51	-54
2420	100	124	142	161	169	172	188	190	135	111	2960	-50	-33	-1	40	80	117	150	171	182	181
2430	57	11	-33	-93	-147	-188	-187	-197	-198	-189	2970	153	137	107	81	36	-7	-53	-99	-134	-153
2440	-182	-153	-114	-59	-3	47	109	162	198	252	2980	-158	-167	-165	-156	-147	-135	-131	-133	-123	-99
2450	228	215	176	125	84	45	5	-38	-90	-143	2990	-78	-52	-26	-5	25	57	81	80	94	108
2460	-198	-265	-267	-261	-224	-148	-124	-120	-120	-120	3000	127	141	140	137	111	73	14	-40	-83	-120
2470	-130	-140	-150	-155	-154	-166	-216	-255	-298	-323	3010	-142	-152	-161	-173	-173	-179	-185	-185	-179	-148
2480	-322	-321	-282	-221	-145	-59	17	95	170	226	3020	-119	-93	-69	-60	-63	-78	-95	-95	-94	-85
2490	265	290	295	293	296	286	260	212	136	64	3030	-79	-53	-33	-14	19	47	85	124	171	203
2500	-28	-92	-175	-199	-199	-199	-200	-197	-187	-153	3040	223	236	242	241	242	234	199	160	122	77
2510	-91	-35	10	50	86	111	115	114	105	79	3050	23	-31	-77	-109	-155	-191	-214	-230	-225	-171
2520	67	50	16	-19	-51	-74	-95	-98	-97	-81	3060	-132	-122	-99	-87	-77	-72	-55	-33	-21	-15
2530	-54	-37	-25	-14	11	42	76	104	140	176	3070	-17	-16	-34	-62	-62	-103	-101	-87	-84	-79
2540	182	178	140	99	67	45	36	36	35	17	3080	-68	-62	-52	-50	-50	-51	-38	-23	-12	9
2550	-61	-69	-69	-88	-72	-30	-12	8	24	27	3090	23	30	38	39	39	40	33	21	11	-2
2560	56	36	47	47	55	60	50	47	66	54	3100	-23	-28	-81	-82	-72	-58	-38	-25	-5	11
2570	73	54	34	8	-16	-27	-37	-45	-36	-14	3110	55	52	59	82	98	128	151	152	167	123
2580	10	34	36	36	35	26	20	9	2	-6	3120	92	64	51	28	8	-5	-16	-30	-39	-59
2590	-30	-54	-90	-116	-121	-119	-123	-108	-57	-12	3130	-59	-59	-48	-23	-3	35	57	71	78	60
2600	27	54	76	105	132	167	202	215	216	216	3140	47	19	4	10	149	20	13	-53	-96	-117
2610	207	196	186	182	173	170	150	112	89	44	3150	-132	-130	-128	-129	-129	-115	-90	-66	-42	-28
2620	9	-6	-9	10	34	37	27	-4	-43	-71	3160	-9	-9	0	6	5	5	5	5	5	5
2630	-88	-105	-113	-131	-156	-182	-215	-238	-302	-354	3170	10	27	48	50	54	67	80	90	96	94
2640	-356	-357	-347	-326	-299	-277	-225	-161	-95	-16	3180	96	92	77	46	-7	-37	-64	-81	-91	-106

TO BE CONTINUED

TO BE CONTINUED

CONTINUED(M-1183 EAST)

Table with columns: NO., (1), (2), (3), (4), (5), (6), (7), (8), (9), (10). Rows 3190-3720.

TO BE CONTINUED

CONTINUED(M-1183 EAST)

Table with columns: NO., (1), (2), (3), (4), (5), (6), (7), (8), (9), (10). Rows 3730-4260.

TO BE CONTINUED

CONTINUED (M-1183 EAST)

CONTINUED (M-1183 EAST)

NO.	(1)	(2)	(3)	(4)	(5)	(6)	(7)	(8)	(9)	(10)
4270	97	113	128	137	141	140	133	115	97	89
4280	65	30	0	-19	-41	-55	-79	-94	-104	-116
4290	-123	-130	-128	-129	-121	-106	-83	-67	-51	-39
4300	-38	-28	-27	-28	-27	-31	-39	-38	-39	-39
4310	-39	-39	-37	-45	-26	-17	-4	-21	-42	-36
4320	-62	-61	-56	-45	-39	-39	-38	-31	-19	-4
4330	11	27	43	62	75	92	118	135	117	109
4340	104	96	94	84	85	82	74	66	61	61
4350	50	51	40	39	37	28	19	10	-2	-4
4360	-13	-28	-36	-40	-38	-39	-40	-51	-49	-55
4370	-62	-61	-50	-39	-35	-34	-17	-10	0	6
4380	5	6	5	6	3	-5	-5	-14	-19	-27
4390	-28	-27	-35	-39	-39	-31	-27	-20	-15	-17
4400	-16	-15	-21	-38	-53	-71	-82	-85	-93	-96
4410	-87	-83	-71	-60	-51	-40	-31	-27	-37	-48
4420	8	4	-5	-5	-5	-6	-15	-19	-28	-27
4430	-28	-27	-27	-28	-27	-17	-16	-16	-16	-16
4440	-19	-28	-26	-38	-52	-46	-44	-34	-22	-61
4450	-70	-84	-83	-84	-83	-84	-82	-90	-95	-96
4460	-89	-83	-81	-72	-72	-61	-61	-53	-46	-39
4470	-30	-26	-29	-22	-10	4	5	11	18	16
4480	18	13	4	-5	-5	-6	0	6	14	36
4490	52	62	79	94	96	93	63	57	57	66
4500	48	40	34	35	35	35	35	35	44	57
4510	57	59	53	37	28	14	6	-5	-16	-27
4520	-38	-50	-66	-77	-92	-109	-113	-129	-133	-133
4530	-131	-121	-112	-96	-73	-56	-33	-17	-8	10
4540	31	50	69	68	69	68	73	88	96	104
4550	95	91	92	75	53	36	28	15	12	3
4560	1	2	1	4	13	13	13	13	12	13
4570	5	-5	-21	-42	-62	-66	-65	-65	-65	-65
4580	-66	-57	-42	-33	-23	-20	-13	-3	10	13
4590	12	2	-9	-19	-20	-20	-20	-20	-20	-20
4600	-20	-20	-19	-10	0	12	13	24	23	29
4610	36	34	36	34	37	28	13	6	-10	-19
4620	-21	-28	-35	-43	-42	-43	-42	-43	-42	-43
4630	-33	-32	-26	-19	-21	-19	-23	-28	-32	-32
4640	-69	-76	-86	-85	-72	-61	-33	-35	-44	-30
4650	-21	-10	7	18	35	44	48	39	34	36
4660	34	36	28	23	24	14	12	13	9	2
4670	-8	-19	-20	-20	-11	-8	-9	0	2	1
4680	1	2	1	3	13	12	13	13	22	25
4690	23	26	34	43	63	69	69	67	57	58
4700	57	58	57	47	57	54	36	50	24	17
4710	12	12	17	25	23	24	24	24	25	19
4720	12	11	-3	-11	-22	-36	-48	-54	-60	-70
4730	-71	-65	-61	-48	-38	-22	-8	5	12	17
4740	30	35	35	35	35	35	35	35	35	35
4750	21	13	-7	-11	-34	-57	-67	-82	-89	-84
4760	-76	-76	-76	-76	-65	-54	-41	-30	-21	-1
4770	21	37	59	70	69	69	69	68	59	54
4780	46	39	29	18	8	1	0	-13	-21	-31
4790	-31	-35	-44	-42	-52	-54	-55	-65	-65	-66
4800	-76	-76	-77	-75	-83	-88	-87	-88	-87	-88

TO BE CONTINUED

TO BE CONTINUED

CONTINUED(M-1183 EAST)										CONTINUED(M-1183 EAST)											
NO.	(1)	(2)	(3)	(4)	(5)	(6)	(7)	(8)	(9)	(10)	NO.	(1)	(2)	(3)	(4)	(5)	(6)	(7)	(8)	(9)	(10)
5350	37	51	66	69	69	69	69	69	69	69	5890	103	94	85	73	63	49	35	36	35	36
5360	69	68	70	61	57	57	53	42	36	27	5900	33	25	20	11	19	28	36	35	35	35
5370	21	12	13	1	-2	-13	-19	-76	-54	-34	5910	35	35	35	35	35	36	46	37	35	35
5380	-46	-53	-57	-66	-76	-76	-58	-76	-76	-76	5920	35	27	16	12	13	12	13	12	13	12
5390	-76	-76	-76	-76	-69	-58	-54	-45	-45	-45	5930	13	12	13	12	20	34	35	35	35	35
5400	-37	-30	-33	-22	-20	-17	0	18	28	35	5940	35	25	24	24	26	35	35	35	35	35
5410	35	35	35	35	36	29	23	16	6	-1											
5420	-10	-8	-18	-20	-19	-9	-9	-8	1	10											
5430	19	28	36	54	59	48	64	70	68	69											
5440	69	69	69	69	69	69	69	69	69	69											
5450	69	69	66	50	36	35	35	35	25	15											
5460	6	-5	-14	-21	-20	-20	-20	-20	-20	-20											
5470	-32	-31	-35	-48	-54	-54	-54	-53	-55	-49											
5480	-38	-22	-7	5	20	47	65	70	68	68											
5490	69	68	69	62	63	30	19	10	1	-7											
5500	-17	-20	-20	-21	-30	-32	-31	-31	-21	-20											
5510	-20	-20	-20	-21	-15	-15	-8	-9	-9	-9											
5520	-9	-9	-9	-9	-9	-9	-9	-9	-9	-9											
5530	-9	-8	0	2	1	1	1	1	2	1											
5540	4	13	12	13	13	13	13	13	13	13											
5550	13	13	13	5	-4	-9	-9	-6	4	10											
5560	19	24	27	36	35	32	23	24	23	24											
5570	24	24	24	24	24	24	24	23	25	17											
5580	12	13	13	7	-2	-18	-30	-33	-43	-42											
5590	-49	-55	-53	-54	-54	-54	-54	-54	-54	-54											
5600	-54	-53	-55	-50	-42	-42	-31	-32	-31	-23											
5610	-15	-7	5	17	28	36	35	35	35	34											
5620	17	12	13	13	12	13	6	0	2	-1											
5630	-14	-21	-20	-20	-21	-13	-9	-18	-8	-32											
5640	-31	-31	-32	-24	-20	-16	-8	-10	-8	-10											
5650	-4	3	0	9	13	12	13	12	13	22											
5660	26	36	34	38	46	54	69	69	69	69											
5670	69	69	69	69	67	52	34	26	15	15											
5680	13	8	-6	-10	-18	-25	-34	-45	-55	-53											
5690	-57	-66	-64	-70	-83	-88	-87	-88	-88	-87											
5700	-88	-98	-106	-114	-109	-98	-98	-79	-58	-54											
5710	-45	-42	-34	-31	-23	-12	-3	7	25	59											
5720	73	81	79	81	91	92	91	100	103	102											
5730	103	103	100	87	80	79	69	69	68	70											
5740	62	57	49	36	27	22	14	6	0	3											
5750	-4	-10	-8	-10	-20	-20	-20	-20	-29	-32											
5760	-31	-32	-31	-31	-31	-31	-31	-31	-31	-22											
5770	-18	-8	7	18	24	24	23	31	36	34											
5780	36	34	43	66	69	69	69	69	69	69											
5790	62	43	23	12	4	-1	-8	-16	-21	-20											
5800	-20	-21	-19	-9	5	5	11	20	24	24											
5810	24	25	18	12	13	13	13	13	13	13											
5820	13	13	13	13	13	13	13	13	13	13											
5830	15	13	13	13	12	13	0	-9	-9	-20											
5840	-20	-25	-41	-42	-51	-54	-54	-54	-62	-66											
5850	-64	-66	-62	-62	-54	-48	-48	-41	-43	-41											
5860	-32	-20	-21	-12	-8	3	14	12	14	6											
5870	1	-5	-11	2	14	24	35	34	39	67											
5880	81	92	102	103	103	102	103	102	103	102											

END

TO BE CONTINUED

RECORD = M-1183 COMPONENT = UP STATION = YAMASHITA-HEN-M
 DATE AND TIME = 1987-12-17-11-08 TOTAL NUMBER OF DATA = 5950
 SAMPLING INTERVAL = 0.010 (SEC) SCAL = 0.10000
 SIGNAL = GR. ACC.

CONTINUED(M-1183 UP)

NO.	(1)	(2)	(3)	(4)	(5)	(6)	(7)	(8)	(9)	(10)
0	-9	-14	25	91	122	70	32	34	20	-24
10	-48	-28	13	79	98	85	80	83	41	-13
20	-36	0	-23	-15	-46	-67	-70	-50	-16	3
30	4	-3	31	-28	-5	-37	-57	-66	-69	-26
40	16	47	52	31	-8	-25	-55	-72	-65	-45
50	0	21	42	39	12	-13	-31	-30	-21	9
60	50	44	16	-12	-17	5	48	52	36	36
70	67	87	58	6	-49	-89	-104	-28	16	-30
80	-56	-22	30	25	-19	-18	-37	-56	-17	-33
90	-80	-110	-97	-23	-2	-22	-47	-57	-7	-20
100	51	73	83	76	40	0	11	77	105	80
110	41	66	47	0	6	22	3	13	55	82
120	107	97	21	-26	-32	-11	8	13	5	-20
130	-28	3	26	27	9	43	17	-26	15	30
140	60	62	48	2	-24	4	0	23	7	-42
150	-64	-30	3	22	44	50	15	-22	-25	-26
160	-35	-24	2	24	45	66	89	102	124	88
170	0	-75	-127	-109	-66	-30	-8	2	9	21
180	15	-19	-63	-26	16	16	-60	-97	-100	-55
190	-116	-86	-26	14	41	52	27	-15	-12	-106
200	-74	-23	27	60	58	25	-9	-67	-87	-87
210	-64	-49	-25	2	32	57	62	63	61	74
220	88	46	16	5	39	58	52	43	67	106
230	138	198	101	14	-67	-114	-98	-43	-7	-32
240	-64	-62	-28	16	16	-16	-60	-97	-100	-55
250	-11	-5	-6	-15	10	66	92	54	-6	-24
260	-81	-74	-45	-17	-20	-52	-75	-46	-6	24
270	-18	-75	-72	-16	31	38	-2	-43	-18	14
280	12	3	9	11	-24	-53	-52	-27	38	52
290	59	36	-23	-55	-20	36	51	52	58	79
300	39	9	47	49	-4	-35	-3	39	82	92
310	70	38	-9	-11	5	13	14	9	-17	-43
320	-29	14	41	33	0	17	19	-61	-143	-183
330	-159	-91	30	78	-11	-89	-112	-75	-81	-85
340	-7	77	90	0	-67	-42	15	82	101	71
350	9	3	-32	-115	-161	-118	-49	4	34	68
360	71	85	49	7	20	37	0	-50	-53	-36
370	-12	13	-6	-62	-74	-76	-64	-39	-10	18
380	25	10	-1	15	30	43	60	70	71	59
390	50	10	-23	-50	-39	1	55	104	124	59
400	-84	-121	-111	-78	-89	-115	-120	-96	-69	-51
410	-9	59	100	82	53	13	-1	47	91	85
420	52	7	-4	-17	-31	7	60	88	90	75
430	35	-16	-55	-27	16	39	1	-54	-100	-141
440	-153	-112	-46	-45	-17	-38	26	56	39	13
450	30	29	-6	-73	-74	-18	46	110	108	78
460	26	-36	-66	-54	-17	5	16	23	1	-20
470	-47	-69	-73	-41	6	46	63	7	-63	-65
480	-16	-1	5	0	-13	0	8	20	19	-5
1000	-140	-145	-155	-163	-161	-164	-156	-102	-78	-39
1010	-5	6	14	11	32	90	102	87	65	41
1020	23	64	128	133	101	52	-5	-15	0	5

TO BE CONTINUED

TO BE CONTINUED

CONTINUED (M-1183 UP)

NO.	(1)	(2)	(3)	(4)	(5)	(6)	(7)	(8)	(9)	(10)
1030	12	33	36	15	-3	-30	-66	-76	-66	-27
1040	-5	-6	20	77	105	66	37	22	66	37
1050	29	31	13	20	64	112	84	27	-21	-21
1060	-37	2	69	116	121	100	91	79	65	65
1070	49	23	-14	-83	-150	-141	-122	-142	-219	-232
1080	-186	-128	-123	-146	-72	7	36	59	63	53
1090	66	131	174	171	113	59	1	-41	-65	-69
1100	-70	-134	-172	-156	-85	-20	20	34	10	20
1110	31	13	0	31	43	12	-16	14	75	77
1120	56	61	103	137	117	83	39	1	-15	10
1130	50	65	51	1	0	7	-25	-29	-10	22
1140	34	25	4	18	69	120	138	115	60	11
1150	18	0	-21	-36	-21	-8	-5	-6	-10	-31
1160	-35	-34	-39	-62	-80	-37	-37	-40	-72	-85
1170	-74	-67	-57	-61	-50	-39	-27	-25	-25	-25
1180	-36	-51	-68	-87	-111	-76	-11	65	85	27
1190	-31	-29	-19	-53	-65	-28	1	3	3	6
1200	16	35	49	53	66	76	82	87	108	108
1210	76	42	62	91	74	84	94	76	49	42
1220	45	44	3	-73	-94	-51	-35	-43	-73	-100
1230	-71	-57	-70	-99	-98	-57	-26	-29	-46	-20
1240	22	43	29	11	4	4	0	-23	-44	-59
1250	-66	-74	-69	-2	1	-68	-64	24	19	5
1260	3	4	-6	-55	-82	-83	-58	-28	0	7
1270	-21	-65	-85	-73	-47	-4	22	43	88	173
1280	234	205	89	52	34	32	34	40	39	-20
1290	-82	-81	-71	-81	-75	-26	46	94	89	39
1300	-15	-60	-54	-40	-41	24	41	49	62	86
1310	106	125	151	180	189	177	141	98	67	23
1320	-2	5	-8	-27	-35	-27	-26	-56	-91	-86
1330	-84	-71	-52	-51	-74	-102	-92	-60	-27	-16
1340	-59	-85	-84	-74	-54	-26	5	47	89	116
1350	101	72	78	84	51	3	-23	-12	43	59
1360	36	40	63	54	30	-12	-96	-145	-109	-57
1370	-12	5	2	5	-6	-5	17	55	86	98
1380	108	108	100	90	67	39	0	-28	-47	-18
1390	20	30	-2	-35	-35	-32	-19	-26	-49	-78
1400	-65	-110	-137	-144	-139	-119	-78	-26	36	26
1410	-64	-90	-116	-91	-56	-1	49	78	75	28
1420	-35	-80	-87	-66	-44	-23	83	76	70	36
1430	23	48	63	68	54	28	22	24	16	-26
1440	-61	-54	-20	4	40	-74	-82	-61	-29	-17
1450	-35	-74	-84	-72	-58	-54	-43	-29	-8	24
1460	9	-12	6	39	62	105	136	137	100	62
1470	38	33	42	42	45	55	77	72	28	-1
1480	-34	-72	-74	-64	-69	-100	-128	-166	-185	-188
1490	-157	-130	-133	-174	-197	-202	-179	-139	-87	-65
1500	-32	13	62	71	53	38	25	30	47	71
1510	86	115	164	173	108	36	1	0	-1	6
1520	-8	-16	17	45	81	61	60	43	36	36
1530	-20	1	39	78	76	37	45	87	82	35
1540	-16	-51	-85	-1	28	-2	-24	-24	-1	31
1550	50	46	26	4	-16	-31	9	36	27	2
1560	-21	-11	18	34	21	-1	0	-14	23	-28

TO BE CONTINUED

CONTINUED (M-1183 UP)

NO.	(1)	(2)	(3)	(4)	(5)	(6)	(7)	(8)	(9)	(10)
1570	-58	-81	-83	-59	-48	-59	-63	-48	-33	-10
1580	9	8	-8	-4	14	30	20	-11	-50	-23
1590	-4	-13	-30	-7	43	89	73	48	37	37
1600	54	57	49	18	-100	-66	-100	-78	-33	-28
1610	-53	-75	-73	-28	-20	-36	-4	33	-36	-36
1620	-60	-66	-41	-24	-48	-50	-28	-6	-15	-23
1630	8	20	-16	-28	-47	29	5	-39	-51	-63
1640	-74	-51	-9	4	3	10	5	-39	-51	-63
1650	40	23	-15	-16	4	3	10	5	-39	-51
1660	-72	-78	-47	-34	-65	-100	-123	-117	-113	-105
1670	-75	-66	-48	0	35	71	93	90	101	135
1680	142	138	127	121	121	123	143	151	150	151
1690	147	113	52	34	58	55	31	-11	-54	-83
1700	-85	-104	-112	-75	-71	-96	-128	-119	-66	-69
1710	-85	-77	-36	53	123	118	50	-39	-67	-57
1720	-11	41	49	61	108	126	80	50	50	9
1730	-9	11	28	0	-13	-25	-25	-25	-25	-13
1740	13	44	68	66	46	21	-9	-4	15	31
1750	4	-32	-44	-34	-53	-6	-104	-103	-104	-88
1760	-73	-74	-74	-66	-30	15	55	94	100	75
1770	64	80	61	32	8	-10	-23	-6	-7	-24
1780	-76	-19	6	28	33	41	72	130	145	119
1790	79	38	11	38	16	-35	-28	-5	14	-9
1800	-61	-86	-103	-104	-99	-69	-50	-18	-49	-97
1810	-111	-114	-112	-124	-130	-90	-66	-71	-75	-84
1820	-52	-30	-2	-7	-26	0	37	71	94	65
1830	93	114	89	56	55	94	105	93	59	33
1840	34	48	43	26	23	26	34	30	11	-9
1850	-16	-9	-4	-8	-55	-46	-44	-56	-88	-79
1860	-17	41	93	112	92	44	4	-5	2	23
1870	47	83	113	116	83	48	63	98	91	45
1880	13	30	75	101	72	38	33	41	53	63
1890	62	56	17	-41	-69	-79	-83	-91	-111	-113
1900	-113	-107	-90	-74	-76	-85	-106	-114	-109	-77
1910	-40	-72	-8	2	23	36	51	89	88	67
1920	34	17	7	23	27	-24	-75	-92	-44	-38
1930	-55	-54	-54	-55	-46	-18	0	-25	-16	0
1940	-35	-36	-3	-22	-42	-43	-29	-25	-2	-4
1950	15	23	13	14	8	5	37	78	90	65
1960	37	33	44	63	85	92	90	67	28	-20
1970	-49	-55	-32	-5	19	32	34	24	17	-27
1980	-84	-73	-68	-57	-67	-59	-51	-24	-28	-46
1990	-86	-120	-123	-114	-86	-63	-42	-34	-32	-21
2000	-5	11	26	37	53	75	80	67	47	42
2010	44	58	80	92	89	75	45	12	16	-10
2020	-12	-19	-26	-13	5	13	0	-27	-36	-7
2030	19	41	34	30	45	30	-6	-30	-35	-31
2040	-24	-24	-32	-82	-107	-90	-61	-32	-75	-94
2050	-75	-57	-49	-85	-106	-81	-8	24	31	34
2060	35	30	14	2	15	68	116	132	129	114
2070	102	102	98	83	56	35	9	-23	-14	38
2080	-20	-23	-14	-15	-34	-79	-94	-93	-80	-55
2090	-30	-24	-25	-24	-25	-18	-14	-17	-61	-84
2100	-92	-79	-69	-72	-68	-58	-38	-26	-35	-72

TO BE CONTINUED

CONTINUED (M-1183 UP)

CONTINUED (M-1183 UP)

NO.	(1)	(2)	(3)	(4)	(5)	(6)	(7)	(8)	(9)	(10)
2110	-50	-10	13	2	-8	22	47	62	83	88
2120	67	29	-2	-12	-20	-28	-36	-44	-44	-45
2130	-39	-11	26	66	81	46	23	26	34	29
2140	8	-5	-15	-15	-15	-15	-10	3	1	-14
2150	-30	-43	-45	-42	-19	2	12	29	31	-4
2160	-29	-42	-24	-6	1	4	0	15	3	8
2170	23	46	48	34	23	4	33	32	43	52
2180	42	45	32	62	-6	-2	10	14	4	-17
2190	-35	-74	-62	-62	-38	7	28	75	109	119
2200	88	74	64	65	55	48	63	58	34	9
2210	4	12	14	7	0	-14	-41	-54	-55	-54
2220	-46	-33	-24	-25	-25	-37	-54	-65	-73	-71
2230	-52	-26	-13	-22	-4	0	-39	-68	-35	1
2240	45	41	-24	-51	-62	-50	-39	-21	-14	-15
2250	-33	13	35	48	46	24	2	-23	-25	-24
2260	-16	-11	-5	-21	-71	-84	-53	-20	-38	-47
2270	-29	-5	10	23	38	38	1	-21	-35	-30
2280	-2	7	-2	-20	-26	-25	-33	-24	-35	-46
2290	-32	-30	-33	-28	-35	-33	-26	-24	-35	-46
2300	-41	-33	-25	-27	-49	-54	-42	-23	-15	-11
2310	-18	-38	-44	-29	-4	27	43	60	20	-1
2320	-3	21	44	42	51	69	61	41	41	3
2330	-10	-15	-15	-10	7	34	43	42	26	11
2340	4	3	5	10	24	42	52	46	20	0
2350	-16	1	22	33	33	30	10	3	6	26
2360	50	63	72	73	83	80	72	63	44	28
2370	-8	-35	-27	-9	-14	-24	-14	-16	-15	-5
2380	17	37	53	60	54	37	9	3	10	10
2390	30	42	43	39	25	2	-19	-40	-56	-67
2400	-74	-74	-67	-49	-33	-22	-30	-56	-73	-75
2410	-72	-56	-34	-35	-20	10	28	44	51	54
2420	61	67	75	85	91	82	82	80	50	46
2430	76	97	102	101	88	65	53	52	61	53
2440	37	30	22	14	17	32	51	51	29	0
2450	-17	-8	1	-15	-24	-15	-5	-21	-41	-63
2460	-61	-53	-55	-53	-63	-57	-29	-7	-14	-36
2470	-57	-63	-37	-13	0	13	24	38	52	47
2480	34	40	45	33	5	-11	-25	-39	-49	-54
2490	-58	-64	-67	-75	-73	-58	-35	-16	-14	-26
2500	-24	-27	-35	-44	-61	-65	-52	-23	-15	-16
2510	-39	-55	-54	-45	-54	-5	12	32	49	67
2520	86	96	102	89	64	39	25	28	50	53
2530	55	53	67	84	69	36	47	65	47	16
2540	12	26	48	68	75	47	47	68	87	89
2550	65	39	28	22	24	22	14	13	14	13
2560	14	-1	-9	24	-10	-33	-46	-35	-34	-45
2570	-63	-44	-14	-2	-18	-26	-25	-24	-36	-69
2580	-67	-29	-6	-6	-2	4	15	32	41	18
2590	-5	-5	-4	6	-4	-16	1	26	17	-2
2600	6	10	25	15	-4	-18	15	37	16	2
2610	9	14	13	14	13	31	44	25	5	0
2620	-23	-40	-39	-34	-34	-21	0	4	-4	-24
2630	-37	-28	-11	7	17	24	22	5	-14	-33
2640	-29	-24	-26	-22	-11	-5	0	4	-12	-13

TO BE CONTINUED

TO BE CONTINUED

CONTINUED(M-1183 UP)

NO.	(1)	(2)	(3)	(4)	(5)	(6)	(7)	(8)	(9)	(10)
3190	7	17	19	33	48	42	18	0	0	13
3200	32	38	36	14	7	8	8	17	24	33
3210	29	4	-1	-1	10	20	38	40	24	5
3220	-2	-15	-25	-31	-30	-31	-23	-20	-21	-21
3230	-20	-21	-18	-1	10	-19	-58	-40	-23	-19
3240	-12	-10	-12	-20	-22	-16	0	8	0	0
3250	12	18	10	7	8	-4	-11	-11	-8	2
3260	9	6	-5	-23	-41	-32	-19	-10	-22	-2
3270	-9	0	-1	-27	-47	-51	-44	-20	-8	-8
3280	-23	-50	-51	-60	-59	-61	-54	-47	-32	-15
3290	-4	-2	-11	8	25	27	31	39	33	18
3300	17	9	7	8	8	8	7	9	15	22
3310	28	36	22	17	18	23	29	23	11	0
3320	0	9	5	-1	-1	-1	-1	-1	-1	0
3330	-1	-1	-1	-11	-19	-36	-59	-60	-60	-59
3340	-60	-53	-49	-51	-43	-16	-11	-11	-11	-7
3350	7	17	27	27	32	45	43	24	16	18
3360	17	23	42	48	46	48	39	38	31	17
3370	17	6	-6	-14	-27	-41	-23	-2	-1	6
3380	8	7	9	17	18	18	18	18	18	18
3390	18	18	18	18	18	18	18	18	18	18
3400	27	28	27	38	59	67	66	65	41	33
3410	54	63	62	55	58	56	57	46	21	0
3420	0	-4	-12	-10	-12	-7	-1	1	10	17
3430	18	18	15	-3	-18	-37	-41	-40	-40	-40
3440	-40	-40	-40	-40	-40	-40	-40	-40	-40	-40
3450	-40	-44	-54	-66	-77	-80	-79	-80	-79	-80
3460	-79	-80	-76	-67	-54	-36	-27	-11	-1	1
3470	16	18	12	0	-1	-14	-22	-19	-5	22
3480	28	23	16	23	28	27	29	38	37	8
3490	46	47	47	34	22	17	19	13	7	8
3500	8	5	0	0	0	0	0	0	0	0
3510	-11	-22	-36	-41	-40	-41	-35	-18	-10	-18
3520	-21	-11	-12	-7	-5	-19	-21	-30	-31	-30
3530	-21	-26	-12	-11	-10	-20	-37	-40	-41	-35
3540	-30	-31	-38	-41	-39	-31	-18	-10	-11	-11
3550	-3	0	-2	1	13	28	49	57	57	48
3560	36	43	48	46	50	58	51	43	36	25
3570	11	0	-1	-1	6	8	8	8	8	8
3580	8	8	8	8	8	8	8	8	8	8
3590	8	6	0	-7	-12	-10	-16	-25	-31	-31
3600	-24	-20	-21	-24	-19	-19	-11	-10	-14	-22
3610	-16	-10	-11	-10	-12	-4	0	-1	-1	-1
3620	-1	-1	-1	-1	-1	-1	-1	-1	-1	-1
3630	-20	-21	-29	-31	-30	-31	-30	-30	-20	-7
3640	5	8	7	8	7	0	-5	-11	-10	-12
3650	-6	0	-1	-1	-1	-1	-1	12	19	17
3660	19	12	7	1	-2	1	8	8	8	8
3670	6	-9	-11	-11	-11	-10	-14	-21	-20	-21
3680	-20	-21	-18	-10	-16	-28	-38	-41	-40	-41
3690	-32	-18	-11	-11	-13	-24	-31	-30	-31	-25
3700	-13	5	1	5	8	8	3	-7	-7	1
3710	9	17	18	17	18	25	31	37	45	48
3720	54	58	53	47	47	47	47	47	47	54

TO BE CONTINUED

CONTINUED(M-1183 UP)

NO.	(1)	(2)	(3)	(4)	(5)	(6)	(7)	(8)	(9)	(10)
3730	63	70	80	95	95	83	67	51	38	29
3740	27	28	35	38	31	18	18	18	18	17
3750	18	17	18	17	19	10	-10	-19	-21	-20
3760	-13	0	8	8	8	8	8	8	7	10
3770	18	17	18	17	18	12	0	0	-10	-19
3780	-28	-40	-40	-40	-40	-40	-40	-41	-34	-26
3790	-14	-4	5	8	7	9	3	-15	-35	-49
3800	-51	-45	-39	-41	-49	-48	-40	-41	-40	-40
3810	-40	-40	-39	-32	-23	-10	-2	12	25	33
3820	38	37	35	26	19	17	20	28	27	28
3830	24	18	15	7	8	8	8	8	8	8
3840	7	-1	-1	-1	-1	-1	-1	-1	-1	-1
3850	-1	-1	-8	-12	-6	7	17	17	18	17
3860	18	17	18	17	18	13	2	-6	-15	-21
3870	-28	-31	-30	-31	-30	-30	-30	-18	-2	-1
3880	-2	1	9	7	16	17	18	17	21	27
3890	33	38	37	38	37	29	19	17	18	18
3900	18	17	18	17	18	17	19	14	8	5
3910	-6	-12	-7	0	-2	-1	-1	-1	-3	-11
3920	-11	-11	-2	-1	-1	-1	-1	-1	-2	4
3930	9	6	-1	-1	-11	-22	-19	-25	-31	-30
3940	-30	-37	-41	-34	-28	-3	-20	-12	-10	-3
3950	8	4	-10	-26	-31	-30	-31	-30	-30	0
3960	-24	-15	-10	-11	-2	-1	-1	-1	-1	-2
3970	3	8	8	6	6	7	10	18	16	16
3980	9	5	-1	-1	-1	8	16	22	29	24
3990	17	8	-1	-1	-1	-1	-1	-1	-1	-1
4000	-1	-2	1	8	7	8	8	8	8	8
4010	8	8	8	8	7	13	23	31	38	44
4020	51	57	57	57	54	27	7	8	5	5
4030	-11	-26	-40	-35	-28	-21	-20	-21	-20	-29
4040	-31	-30	-31	-32	-20	-21	-21	-21	-21	-21
4050	-21	-21	-21	-21	-20	-21	-12	-11	-11	-11
4060	-5	0	-1	-1	-1	-1	-1	-1	-1	-1
4070	-1	-1	-1	-1	-1	-1	-1	-1	-1	-1
4080	-2	2	8	8	4	-4	-11	-10	-15	-21
4090	-27	-31	-32	-32	-32	-35	-35	-30	-27	-18
4100	-10	-13	-20	-25	-32	-29	-22	-13	-10	0
4110	11	17	18	17	19	13	7	6	-2	0
4120	-8	-11	-11	-11	-11	-11	-11	-11	-11	-11
4130	-11	-11	-11	-11	-11	-10	-12	-6	0	10
4140	17	22	28	27	25	17	18	17	18	17
4150	18	18	18	18	18	17	18	17	8	8
4160	8	9	17	18	18	18	17	18	17	18
4170	15	5	-3	-10	-16	-21	-9	-2	0	-10
4180	-21	-20	-13	-2	1	5	11	19	11	8
4190	8	16	17	23	28	30	38	41	55	56
4200	63	67	66	67	66	67	66	67	66	67
4210	65	57	52	40	37	36	28	27	28	23
4220	17	12	5	0	-2	0	-3	-11	-10	-10
4230	-15	-21	-31	-29	-33	-40	-42	-50	-50	-50
4240	-54	-61	-59	-67	-70	-76	-81	-77	-68	-51
4250	-60	-60	-69	-70	-69	-60	-48	-40	-30	-30
4260	-19	-28	-31	-24	-18	-11	-4	8	17	27

TO BE CONTINUED

NO.	(1)	(2)	(3)	(4)	(5)	(6)	(7)	(8)	(9)	(10)	(11)	(12)	(13)	(14)	(15)	(16)	(17)	(18)	(19)	(20)
4270	37	45	52	57	57	57	57	50	40	36										
4280	42	48	56	55	46	47	37	42	47	49										
4290	58	56	58	51	35	19	8	1	-9	-11										
4300	-11	-11	-11	-11	-11	-11	-11	-11	-11	-11										
4310	-10	-14	-22	-31	-40	-40	-40	-40	-41	-40										
4320	-41	-35	-30	-30	-31	-30	-30	-30	-31	-30										
4330	-31	-27	-20	-20	-11	-10	-12	-5	-1	6										
4340	3	-2	-3	-20	-28	-32	-27	-12	-2	10										
4350	17	18	19	18	17	18	12	17	7	-1										
4360	0	9	18	18	18	18	17	18	17	18										
4370	12	6	9	0	-11	-12	-21	-20	-21	-21										
4380	-20	-21	-17	-10	-12	-10	-12	-7	0	-1										
4390	-1	-1	-1	-1	-1	-1	-1	-1	-1	-1										
4400	-1	-1	-1	-1	-1	-1	-1	-1	-1	-1										
4410	-1	-1	0	-5	-12	-10	-2	-1	0	8										
4420	8	17	18	17	18	17	18	17	19	13										
4430	7	8	8	4	-3	1	8	17	17	18										
4440	15	6	-10	-26	-35	-40	-31	-30	-30	-30										
4450	-31	-30	-31	-30	-38	-41	-40	-40	-40	-41										
4460	-60	-60	-27	-11	-3	0	-1	-8	-14	-24										
4470	-31	-30	-31	-30	-31	-27	-20	-21	-19	-11										
4480	-11	-11	-11	-11	-9	-2	3	9	8	8										
4490	8	8	8	7	9	2	-2	0	-1	0										
4500	-9	-11	-11	-11	-11	-10	-15	-22	-19	-27										
4510	-31	-30	-31	-29	-34	-41	-47	-51	-45	-39										
4520	-32	-21	-20	-21	-20	-29	-31	-30	-31	-30										
4530	-31	-23	2	17	19	28	27	28	27	28										
4540	26	18	18	18	18	9	8	7	14	19										
4550	10	1	-1	-1	-1	-1	-1	-1	-1	-2										
4560	6	25	28	28	22	4	-1	-7	-11	-10										
4570	-11	-11	-4	0	-11	-10	-15	-21	-20	-21										
4580	-21	-20	-27	-31	-30	-31	-30	-30	-30	-30										
4590	-30	-30	-30	-30	-30	-30	-30	-30	-30	-30										
4600	-30	-30	-30	-30	-24	-17	-11	-10	-11	-8										
4610	0	-1	0	-1	0	-6	-12	-10	-11	-10										
4620	-14	-21	-20	-22	-29	-31	-29	-22	-12	-11										
4630	-6	0	-1	-1	-1	-1	-1	0	8	8										
4640	8	8	8	8	7	9	2	-1	-2	-10										
4650	-22	-32	-30	-31	-30	-30	-30	-30	-30	-30										
4660	-30	-30	-30	-30	-30	-30	-30	-30	-30	-30										
4670	-31	-21	-10	-11	-10	-11	-10	-12	-5	0										
4680	-1	-1	-1	-1	-1	-1	-1	-1	-1	-1										
4690	-1	-1	-1	-1	-2	-13	-20	-31	-40	-40										
4700	-40	-39	-44	-47	-50	-49	-42	-42	-36	-30										
4710	-30	-30	-20	-10	-11	-10	-11	-11	-11	-10										
4720	-2	0	-3	-11	-11	-11	-11	-11	-11	-11										
4730	-11	-11	-11	-11	-11	-11	-11	-11	-11	-11										
4740	-21	-20	-21	-20	-21	-20	-21	-20	-21	-20										
4750	-10	-11	-10	-11	-10	-11	-10	-11	-10	-11										
4760	-1	-1	-1	-1	-1	-1	-1	0	-6	-12										
4770	-9	-2	-1	-1	-1	-1	-1	-1	-1	-1										
4780	-1	-1	-1	0	-2	3	9	8	8	8										
4790	8	8	8	8	9	2	-2	0	-1	-1										
4800	-1	-1	-1	0	8	8	7	-1	-1	-1										

TO BE CONTINUED

TO BE CONTINUED

CONTINUED (M-1183 UP)

CONTINUED (M-1183 UP)

NO.	(1)	(2)	(3)	(4)	(5)	(6)	(7)	(8)	(9)	(10)
5350	25	18	7	-1	-1	0	-5	-12	-10	-11
5360	-11	-20	-21	-20	-16	-8	-1	-8	8	8
5370	8	8	5	-1	-1	-1	-1	5	9	7
5380	9	7	13	18	17	18	18	18	18	17
5390	9	7	9	5	-1	-1	-1	-1	0	-6
5400	-12	-9	-16	-20	-23	-31	-30	-31	-30	-31
5410	-26	-9	-1	1	7	8	8	8	8	8
5420	8	8	8	0	-1	-1	-1	-1	-1	-1
5430	-1	-1	-1	-1	-1	-1	-1	6	8	8
5440	8	8	8	8	8	8	8	8	8	8
5450	8	13	22	28	27	28	27	28	29	21
5460	18	12	8	3	0	-2	2	2	9	7
5470	9	15	24	28	27	36	38	37	37	37
5480	37	37	37	37	37	37	37	37	37	37
5490	37	37	46	47	48	41	36	38	37	38
5500	37	38	30	27	21	19	13	7	8	8
5510	8	8	8	8	8	8	8	8	8	8
5520	8	7	15	18	22	28	27	27	37	37
5530	38	37	40	47	47	47	47	47	48	44
5540	37	37	38	32	27	28	27	28	27	18
5550	18	11	5	0	0	-6	-11	-11	-10	-11
5560	-10	-11	-11	-11	-11	-11	-11	-11	-11	-11
5570	-1	0	-1	6	-1	0	-3	-9	-17	-17
5580	-21	-23	-31	-30	-30	-30	-30	-30	-30	-30
5590	-30	-30	-30	-30	-30	-30	-30	-30	-30	-31
5600	-30	-31	-26	-20	-24	-31	-30	-27	-19	-19
5610	-21	-19	-11	-11	-3	0	-4	-12	-7	0
5620	-1	-1	-1	6	14	25	28	27	28	28
5630	27	27	19	18	18	16	8	8	8	8
5640	8	8	8	8	8	8	8	8	8	8
5650	7	8	8	8	8	8	8	8	8	8
5660	8	8	7	0	-1	0	-2	-9	-15	-15
5670	-22	-29	-31	-30	-30	-30	-30	-30	-30	-31
5680	-28	-21	-14	-10	-10	-11	-11	-11	-11	-11
5690	-11	-11	-10	-12	-17	-10	-11	-10	-12	-6
5700	0	-1	-1	-1	-1	-1	6	9	8	8
5710	7	13	27	37	37	37	37	37	37	37
5720	37	37	37	37	37	37	37	37	37	37
5730	37	37	37	45	48	41	37	38	37	37
5740	37	37	37	37	38	37	38	31	28	24
5750	17	17	8	8	8	8	7	9	4	-2
5760	0	-1	-1	-1	-1	-1	-1	-1	-1	-1
5770	-1	-1	-1	-1	-1	-1	-1	-1	-1	-1
5780	-1	-1	-1	-1	-1	-1	-1	7	12	18
5790	18	16	7	9	15	18	18	17	22	18
5800	28	27	28	28	27	20	13	7	8	0
5810	-1	-1	-1	-1	-1	2	25	28	27	8
5820	29	23	18	18	17	19	13	20	29	29
5830	36	38	37	37	37	44	48	47	47	47
5840	47	47	47	38	38	35	27	28	27	28
5850	27	28	27	18	17	18	17	20	29	20
5860	18	10	8	1	-2	-1	-1	-1	-1	-1
5870	0	-4	-11	-15	-22	-15	-10	-11	-11	-11
5880	-10	-11	-9	-9	-10	-11	-11	-11	-11	-11

TO BE CONTINUED

RECORD = F-95 COMPONENT = N33E STATION = YAMASHITA-F
 DATE AND TIME = 1987-12-17-11-8 TOTAL NUMBER OF DATA = 6000
 SAMPLING INTERVAL = 0.010 (SEC) SCAL = 0.10000
 SIGNAL = GR. ACC.

CONTINUED(F-95 N33E)
 NO. (1) (2) (3) (4) (5) (6) (7) (8) (9) (10)

490	1	-9	0	0	0	0	0	2	1	2	1	2	1	1	0
500	0	1	1	4	0	1	4	0	0	0	0	0	0	0	0
510	1	0	0	2	2	2	2	2	2	2	2	2	2	2	2
520	0	0	4	4	0	0	0	0	0	0	0	0	0	0	0
530	4	1	0	2	0	0	0	0	0	0	0	0	0	0	0
540	1	0	1	2	0	0	0	0	0	0	0	0	0	0	0
550	1	2	2	2	0	0	0	0	0	0	0	0	0	0	0
560	0	1	2	2	0	0	0	0	0	0	0	0	0	0	0
570	0	2	1	1	1	1	1	1	1	1	1	1	1	1	1
580	-1	1	2	2	0	0	0	0	0	0	0	0	0	0	0
590	1	1	1	2	0	0	0	0	0	0	0	0	0	0	0
600	1	4	2	2	4	1	1	1	1	1	1	1	1	1	1
610	2	0	0	0	0	0	0	0	0	0	0	0	0	0	0
620	2	2	2	2	0	0	0	0	0	0	0	0	0	0	0
630	1	1	0	0	2	1	1	1	1	1	1	1	1	1	1
640	-9	-9	0	10	4	4	7	8	0	-4	0	-3	0	-3	0
650	4	1	0	0	0	0	0	0	0	0	0	0	0	0	0
660	0	1	2	1	0	0	0	0	0	0	0	0	0	0	0
670	1	2	0	0	0	0	0	0	0	0	0	0	0	0	0
680	0	1	1	0	0	0	0	0	0	0	0	0	0	0	0
690	1	1	2	2	0	0	0	0	0	0	0	0	0	0	0
700	1	0	0	0	2	0	2	0	2	0	2	0	2	0	2
710	1	0	2	1	1	1	1	1	1	1	1	1	1	1	1
720	1	1	0	1	2	0	0	0	0	0	0	0	0	0	0
730	2	0	2	0	2	0	2	0	2	0	2	0	2	0	2
740	1	0	0	2	1	0	2	0	2	0	2	0	2	0	2
750	1	0	0	0	0	0	0	0	0	0	0	0	0	0	0
760	4	1	1	2	1	0	2	0	2	0	2	0	2	0	2
770	0	2	2	2	0	0	0	0	0	0	0	0	0	0	0
780	0	0	0	2	2	0	4	0	0	0	0	0	0	0	0
790	2	1	0	0	0	0	0	0	0	0	0	0	0	0	0
800	1	0	0	1	1	1	1	1	1	1	1	1	1	1	1
810	0	2	1	1	1	1	1	1	1	1	1	1	1	1	1
820	2	1	1	2	1	1	1	1	1	1	1	1	1	1	1
830	0	0	0	0	0	0	0	0	0	0	0	0	0	0	0
840	0	0	0	0	0	0	0	0	0	0	0	0	0	0	0
850	4	1	2	0	0	0	0	0	0	0	0	0	0	0	0
860	2	0	2	0	0	0	0	0	0	0	0	0	0	0	0
870	1	1	0	0	0	0	0	0	0	0	0	0	0	0	0
880	0	0	0	0	0	0	0	0	0	0	0	0	0	0	0
890	0	0	0	0	0	0	0	0	0	0	0	0	0	0	0
900	4	0	1	2	0	0	0	0	0	0	0	0	0	0	0
910	1	0	0	1	2	0	0	0	0	0	0	0	0	0	0
920	0	0	0	0	0	0	0	0	0	0	0	0	0	0	0
930	-9	-2	-2	0	0	0	0	0	0	0	0	0	0	0	0
940	-3	-4	0	0	0	0	0	0	0	0	0	0	0	0	0
950	-9	-4	1	5	0	0	0	0	0	0	0	0	0	0	0
960	5	4	2	0	0	0	0	0	0	0	0	0	0	0	0
970	-2	-3	-2	0	0	0	0	0	0	0	0	0	0	0	0
980	-10	-12	-10	-9	1	0	0	0	0	0	0	0	0	0	0
990	3	5	5	0	0	0	0	0	0	0	0	0	0	0	0
1000	4	10	15	17	19	25	21	15	11	13	13	13	13	13	13
1010	17	13	8	2	1	0	0	0	0	0	0	0	0	0	0
1020	-34	-23	-14	-9	-12	-15	-10	-16	-27	-30	-30	-30	-30	-30	-30

TO BE CONTINUED

TO BE CONTINUED

CONTINUED(F-95

N33E)

CONTINUED(F-95

N33E)

NO.	(1)	(2)	(3)	(4)	(5)	(6)	(7)	(8)	(9)	(10)
1030	26	29	27	10	-9	-1	13	29	49	48
1040	29	20	17	13	-9	-15	-27	-29	-36	-42
1050	-49	-43	-38	-31	-15	2	16	28	29	21
1060	9	7	15	24	27	20	14	12	14	10
1070	1	-9	-20	-29	-35	-33	-25	-19	-11	2
1080	1	-10	-23	-25	-10	10	24	38	48	52
1090	60	68	69	68	49	28	4	-10	-19	-35
1100	-57	-78	-88	-72	-64	-71	-74	-55	-54	-54
1110	-13	0	20	40	63	83	91	85	66	54
1120	30	44	34	27	24	22	21	10	-9	-18
1130	-30	-46	-61	-74	-88	-84	-67	-56	-39	-25
1140	-9	27	47	54	49	52	64	68	68	63
1150	4	21	12	17	25	12	17	16	14	10
1160	-29	-38	-49	-54	-62	-61	-53	-43	-35	-27
1170	-19	-10	3	22	29	36	39	49	68	76
1180	63	40	3	21	28	25	9	-24	-55	-69
1190	-58	-49	-49	-69	-80	-76	-57	-39	-23	0
1200	29	54	69	80	99	94	78	59	34	10
1210	0	4	13	15	10	-9	-9	-4	-12	-23
1220	-30	-30	-26	-36	-51	-51	-21	-38	-48	-43
1230	-18	-14	-9	2	10	21	38	48	43	38
1240	26	10	5	15	17	15	10	5	8	10
1250	7	4	6	16	16	15	0	9	18	22
1260	21	10	0	-1	9	17	20	24	24	21
1270	0	-31	-49	-49	-49	-24	-2	15	13	6
1280	-10	-29	-42	-41	-27	0	24	29	36	44
1290	47	47	41	26	5	-17	-42	-58	-56	-49
1300	-24	-9	6	2	-1	11	24	16	0	-12
1310	-15	-19	-12	-14	-20	-32	-49	-49	-30	-9
1320	-9	-18	-14	16	56	80	88	81	65	60
1330	60	43	1	-39	-60	-51	-34	-12	-2	-5
1340	-10	4	14	16	4	-12	-27	-35	-32	-18
1350	2	19	15	2	-12	-19	-20	20	29	29
1360	33	28	35	47	59	49	26	0	-18	-24
1370	-17	4	27	34	34	25	12	0	-9	-10
1380	-5	-29	-36	-23	-4	1	0	0	11	19
1390	4	-19	-32	-36	-31	-18	0	0	11	19
1400	-9	-49	-36	-13	15	25	19	21	29	39
1410	45	41	41	37	29	36	37	29	15	-4
1420	-3	9	-14	-29	-36	-33	-27	-19	-12	-9
1430	-21	-42	-49	-32	-9	10	11	7	20	47
1440	69	77	59	22	-17	-38	-38	-29	-39	-57
1450	-58	-41	-23	-20	-25	-14	10	24	25	10
1460	-11	-18	-12	-9	-14	-31	-44	-38	-29	-25
1470	-30	-15	20	60	88	97	91	83	85	85
1480	79	55	55	20	5	-9	-19	-29	-27	-19
1490	-7	-50	-32	-33	-43	-49	-36	-18	-9	-9
1500	-18	-38	-50	-49	-32	-9	5	4	5	5
1510	17	21	11	6	10	24	29	38	43	48
1520	50	46	37	36	29	19	10	26	24	42
1530	49	43	20	-18	-49	-49	-33	-22	-24	-26
1540	-22	-14	3	7	4	-10	-15	-23	-35	-49
1550	-40	-19	5	22	29	28	10	-20	-36	-25
1560	-9	6	22	29	31	28	1	-14	-23	-36

TO BE CONTINUED

TO BE CONTINUED

NO.	(1)	(2)	(3)	(4)	(5)	(6)	(7)	(8)	(9)	(10)
2110	-131	-116	-103	-89	-69	-49	-12	15	28	23
2120	12	15	42	81	101	91	64	29	-2	-17
2130	-22	-23	-36	-49	-88	-106	-110	143	174	161
2140	117	64	4	-49	-49	-100	-168	-235	-290	-344
2150	-15	-1	1	-14	-49	-100	-168	-235	-290	-344
2160	393	-433	-458	-464	-463	-460	-439	-390	-319	-222
2170	105	19	139	238	326	422	494	541	544	504
2180	426	322	200	88	-9	-76	-110	-120	-116	-103
2190	-98	-107	-119	-140	-168	-188	-200	-200	-185	-143
2200	-70	10	86	153	234	307	361	386	405	401
2210	386	365	344	346	346	346	346	346	346	346
2220	66	4	-65	-162	-247	-312	-396	-462	-494	-538
2230	-564	-545	-535	-499	-453	-370	-294	-207	-103	-9
2240	83	144	178	224	287	343	361	346	327	302
2250	284	288	296	282	267	279	314	351	375	386
2260	396	366	327	271	200	131	69	9	-25	-49
2270	-62	-69	-69	-117	-179	-248	-321	-381	-410	-406
2280	-380	-341	-287	-208	-138	-74	-15	44	108	165
2290	217	262	291	392	276	239	234	178	109	51
2300	-5	-54	-106	-147	-170	-199	-240	-291	-336	-337
2310	287	232	168	-96	-41	39	80	119	131	131
2320	104	67	22	-69	-119	-190	-262	-317	-331	-307
2330	-267	-162	-88	-9	72	141	208	256	279	282
2340	287	254	246	247	242	225	188	148	128	119
2350	96	88	80	63	44	21	-9	-10	-12	-9
2360	17	35	36	28	20	6	-14	-30	-28	-9
2370	12	29	61	75	65	18	-51	-128	-190	-248
2380	287	326	349	348	-372	-357	-326	-297	-287	-272
2390	-272	-262	-227	-175	-130	-60	10	91	164	227
2400	289	332	366	366	398	386	386	385	376	356
2410	326	277	210	138	65	-9	-74	-131	-177	-192
2420	-187	-187	-168	-141	-110	-66	-20	27	69	100
2430	108	104	96	81	61	29	20	19	6	-15
2440	-40	-57	-88	-98	-128	-146	-168	-168	-141	-115
2450	-119	-111	-116	-117	-100	-79	-52	-19	26	88
2460	166	198	215	212	211	210	217	227	247	258
2470	252	214	148	74	0	-63	-116	-146	-168	-184
2480	-192	-200	-207	-212	-228	-231	-212	-170	-128	-100
2490	-78	-66	-49	-38	-32	-23	-26	-49	-69	-77
2500	-71	-66	-55	-60	-79	-94	-103	-103	-96	-89
2510	-78	-54	-27	2	41	76	109	145	166	188
2520	215	235	265	307	357	386	409	416	413	399
2530	371	346	334	359	318	282	218	145	78	17
2540	-39	-99	-146	-179	-213	-252	-287	-303	-313	-320
2550	-314	-287	-247	-207	-160	-113	-56	14	85	148
2560	198	256	303	339	376	384	346	287	199	90
2570	-25	-138	-235	-306	-351	-371	-366	-317	-257	-175
2580	-89	-9	86	174	253	326	386	445	476	465
2590	426	363	274	185	106	39	-63	-103	-153	-207
2600	-252	-296	-324	-326	-287	-233	-169	-96	-21	49
2610	109	146	148	142	129	116	107	101	95	88
2620	81	69	69	58	29	9	-9	-24	-51	-44
2630	-88	-111	-129	-139	-157	-188	-207	-223	-250	-290
2640	-335	-376	-413	-435	-450	-451	-441	-419	-385	-335

TO BE CONTINUED

TO BE CONTINUED

CONTINUED (F-95 N33E)														
CONTINUED (F-95 N33E)														
NO.	(1)	(2)	(3)	(4)	(5)	(6)	(7)	(8)	(9)	(10)				
3190	-24	37	84	118	166	169	180	174	158	135				
3200	174	90	63	29	21	-2	-18	-34	-54	-69				
3210	-82	-97	-98	-84	-56	-33	-17	-10	-9	1				
3220	11	29	64	92	109	131	148	163	148	135				
3230	101	63	22	-19	-69	-113	-147	-186	-218	-241				
3240	-252	-248	-243	-237	-219	-191	-157	-113	-65	12				
3250	-24	14	48	81	107	126	137	147	138	133				
3260	122	107	106	118	138	153	148	122	89	34				
3270	-1	-24	-36	-49	-69	-88	-88	-91	-89	-95				
3280	-97	-99	-93	-88	-73	-57	-29	9	49	87				
3290	109	115	109	106	116	134	143	148	163	171				
3300	171	163	148	138	129	107	69	36	12	0				
3310	-5	-20	-36	-57	-84	-97	-89	-69	-38	0				
3320	37	69	98	109	130	130	145	161	173	181				
3330	183	182	166	140	109	74	44	12	-15	-49				
3340	-69	-93	-114	-129	-143	-156	-159	-149	-134	-122				
3350	-105	-84	-54	-34	-25	-29	-36	-49	-61	-71				
3360	-79	-93	-92	-88	-73	-62	-59	-62	-73	-88				
3370	-94	-105	-111	-116	-117	-128	-128	-136	-137	-131				
3380	-128	-110	-103	-88	-64	-30	10	56	96	132				
3390	148	173	188	202	218	232	260	288	306	327				
3400	328	327	323	327	307	285	276	258	247	227				
3410	218	198	174	147	119	94	69	49	28	12				
3420	0	-15	-33	-50	-74	-92	-104	-118	-131	-133				
3430	-137	-141	-148	-163	-174	-179	-178	-174	-178	-185				
3440	-188	-185	-190	-200	-210	-220	-232	-241	-248	-254				
3450	-249	-238	-228	-214	-207	-195	-176	-149	-128	-88				
3460	-50	-11	28	60	84	97	101	100	99	109				
3470	127	147	171	183	188	198	200	200	188	169				
3480	143	109	83	58	34	10	-20	-29	-49	-71				
3490	-112	-136	-159	-192	-221	-243	-256	-259	-253	-228				
3500	-188	-144	-104	-72	-56	-56	-59	-64	-59	-49				
3510	-14	19	64	98	116	119	109	106	106	110				
3520	123	141	165	187	208	227	243	237	234	204				
3530	183	170	168	166	162	142	136	135	153	153				
3540	124	107	88	64	47	35	29	24	27	29				
3550	58	41	40	29	19	9	2	4	10	27				
3560	39	54	68	67	58	48	28	0	-23	-51				
3570	-88	-119	-147	-170	-188	-210	-230	-250	-270	-287				
3580	-287	-284	-274	-267	-250	-227	-207	-178	-153	-133				
3590	-116	131	155	171	180	185	188	195	203	218				
3600	131	155	171	180	185	188	195	203	218	239				
3610	247	256	250	247	235	213	187	158	127	92				
3620	63	27	-9	-26	-42	-54	-69	-89	-111	-130				
3630	-141	-153	-168	-168	-157	-145	-125	-102	-88	-79				
3640	-77	-74	-66	-61	-58	-59	-67	-79	-88	-88				
3650	-88	-97	-109	-124	-139	-148	-147	-138	-123	-102				
3660	-88	-65	-51	-39	-34	-33	-31	-35	-38	-28				
3670	-10	13	37	69	97	116	123	118	121	129				
3680	144	162	185	198	203	203	199	188	173	153				
3690	138	125	108	85	63	45	23	-9	-39	-78				
3700	-121	-163	-203	-232	-247	-253	-247	-227	-208	-185				
3710	-168	-145	-128	-89	-53	-22	10	44	83	118				
3720	148	173	188	218	227	227	227	220	214	215				

TO BE CONTINUED

TO BE CONTINUED

CONTINUED(F-95

M33E)

CONTINUED(F-95

M33E)

NO.	(1)	(2)	(3)	(4)	(5)	(6)	(7)	(8)	(9)	(10)
4270	131	129	121	114	104	93	79	60	44	29
4280	10	7	4	6	9	17	22	22	16	5
4290	2	4	10	29	29	29	29	29	40	45
4300	47	55	63	69	69	69	63	53	39	19
4310	6	-6	-14	-23	-32	-40	-49	-49	-43	-39
4320	-44	-49	-56	-62	-64	-61	-58	-49	-49	-44
4330	-40	-34	-33	-36	-38	-36	-36	-36	-30	-24
4340	-17	-11	-15	-17	-28	-40	-54	-70	-75	-77
4350	-79	-78	-75	-69	-64	-54	-51	-67	-62	-48
4360	-52	-39	-36	-36	-21	1	39	89	97	48
4370	53	56	63	68	69	79	84	89	93	100
4380	103	104	104	101	108	114	115	118	119	109
4390	100	84	59	37	19	2	-10	-18	-24	-34
4400	-39	-44	-39	-38	-34	-30	-27	-27	-28	-29
4410	-27	-29	-25	-17	-19	-21	-17	-17	-23	-14
4420	-27	-19	-9	2	10	25	29	44	54	63
4430	68	69	65	61	50	46	34	26	23	10
4440	19	23	25	24	18	13	7	7	5	5
4450	0	-9	-20	-35	-50	-64	-70	-73	-74	-69
4460	-54	-49	-39	-27	-19	-10	1	10	15	16
4470	20	27	29	29	29	36	45	54	55	55
4480	58	49	43	29	24	15	4	-4	-9	-10
4490	-11	-12	-9	-9	2	11	21	27	29	35
4500	29	29	24	18	8	6	2	4	4	2
4510	4	3	11	19	24	28	29	41	49	52
4520	52	59	55	54	54	54	54	56	55	58
4530	54	54	49	45	40	36	29	23	16	9
4540	1	-9	-12	-19	-27	-30	-30	-34	-39	-40
4550	-44	-49	-49	-50	-50	-51	-53	-52	-56	-61
4560	-65	-67	-76	-89	-109	-130	-146	-177	-190	-190
4570	-188	-183	-168	-148	-128	-93	-57	-23	10	44
4580	78	105	134	154	174	188	188	188	183	174
4590	156	134	108	84	66	48	29	13	-9	-18
4600	-34	-49	-50	-55	-60	-58	-59	-57	-59	-61
4610	-58	-54	-49	-41	-41	-40	-49	-41	-42	-39
4620	-34	-29	-18	-10	-9	-10	-14	-25	-37	-49
4630	-49	-41	-36	-27	-10	6	22	41	59	81
4640	97	114	130	145	156	165	171	175	178	182
4650	178	171	157	132	103	68	29	4	-20	-49
4660	-58	-77	-98	-114	-129	-147	-158	-168	-173	-175
4670	-171	-163	-149	-137	-118	-103	-81	-57	-38	-18
4680	0	15	29	49	67	79	91	91	88	88
4690	69	63	54	44	32	29	35	29	29	23
4700	63	64	66	59	50	38	28	21	23	23
4710	24	25	23	10	0	-12	-22	-30	-34	-32
4720	-25	-14	-9	2	2	0	2	4	3	2
4730	1	1	2	2	10	6	7	13	19	20
4740	22	19	16	10	4	-9	-10	-18	-29	-34
4750	-44	-51	-60	-71	-88	-93	-99	-107	-112	-113
4760	-113	-113	-109	-113	-108	-104	-101	-98	-93	-89
4770	-82	-72	-66	-60	-49	-37	-23	-10	6	19
4780	29	44	55	67	69	75	69	69	63	59
4790	54	57	60	60	60	62	47	34	26	26
4800	16	10	10	10	22	29	50	67	86	101

TO BE CONTINUED

TO BE CONTINUED

CONTINUED(F-95 N33E)

CONTINUED(F-95 N33E)

NO.	(1)	(2)	(3)	(4)	(5)	(6)	(7)	(8)	(9)	(10)
5550	-38	-49	-56	-66	-68	-74	-76	-76	-82	-88
5560	-88	-88	-88	-88	-76	-58	-49	-49	-37	-32
5570	-23	-17	-11	-9	-1	4	10	17	23	27
5580	29	29	29	29	29	35	39	40	42	43
5590	62	39	60	43	49	54	59	62	63	64
5600	60	59	56	51	44	47	42	37	29	29
5610	22	21	10	7	1	-12	-20	-36	-49	-58
5620	-77	-98	-128	-133	-140	-145	-146	-143	-143	-143
5630	-141	-137	-131	-128	-123	-115	-110	-102	-92	-84
5640	-74	-63	-58	-69	-60	-30	-20	-10	1	17
5650	26	34	44	52	60	66	69	80	81	86
5660	86	91	94	98	101	104	106	109	123	130
5670	140	145	146	148	148	156	159	156	155	148
5680	148	143	136	123	108	86	69	49	29	10
5690	-10	-27	-49	-59	-73	-88	-93	-103	-114	-128
5500	-129	-131	-136	-136	-136	-134	-133	-132	-132	-129
5510	-130	-128	-118	-109	-98	-88	-84	-68	-65	-57
5520	-51	-49	-49	-49	-41	-38	-32	-27	-19	-12
5530	-9	-9	-9	-7	0	2	8	10	10	10
5540	16	25	27	29	26	28	27	28	27	24
5550	29	29	27	25	24	22	20	10	4	1
5560	-3	-4	-9	-9	-9	-5	-9	-4	-9	-9
5570	0	4	10	13	18	19	19	17	14	11
5580	11	6	1	-3	-9	-9	-9	0	0	0
5590	2	0	-4	-12	-20	-29	-31	-34	-33	-32
5600	-30	-34	-34	-31	-31	-28	-25	-17	-14	-4
5610	2	6	5	4	4	-9	-9	-2	-9	-4
5620	-9	-10	-13	-15	-18	-18	-17	-14	-10	-1
5630	1	2	3	4	4	2	4	0	2	4
5640	3	7	13	19	23	39	38	62	66	69
5650	53	53	52	54	54	54	53	54	55	55
5660	54	50	44	40	29	27	21	10	6	-3
5670	-15	-24	-32	-40	-45	-50	-54	-54	-53	-53
5680	-51	-49	-39	-35	-25	-19	-10	0	9	15
5690	20	24	29	29	34	39	44	44	49	52
5700	55	49	55	53	51	47	43	34	28	25
5710	22	21	18	10	10	7	10	9	9	9
5720	4	-3	-9	-12	-19	-23	-28	-32	-32	-39
5730	-62	-49	-51	-59	-67	-72	-78	-82	-89	-91
5740	-90	-92	-90	-88	-80	-76	-69	-62	-54	-49
5750	-37	-31	-23	-17	-11	-10	-10	-10	-10	-17
5760	-18	-16	-17	-14	-15	-13	-10	-9	-9	-9
5770	-4	-9	0	2	5	13	19	26	29	64
5780	49	58	64	65	69	69	67	63	60	59
5790	51	44	29	24	13	9	0	-11	-18	-24
5800	-29	-30	-25	-21	-20	-14	-10	-9	-9	-4
5810	-9	-9	-9	-4	-10	-12	-12	4	4	-10
5820	-9	-9	-9	-9	6	5	4	11	20	24
5830	27	24	25	27	28	27	24	23	22	27
5840	27	24	23	22	25	23	22	18	10	13
5850	11	12	12	15	25	35	45	54	62	68
5860	74	81	84	85	85	84	80	69	64	56
5870	42	29	17	12	0	-9	-12	-9	-14	-11
5880	-15	-18	-23	-25	-34	-49	-50	-56	-60	-60

TO BE CONTINUED

END

RECORD = F-95 COMPONENT = E33S STATION = YAMASHITA-F
 DATE AND TIME = 1987-12-17-11-8 TOTAL NUMBER OF DATA = 6000
 SAMPLING INTERVAL = 0.010 (SEC) SCAL = 0.10000
 SIGNAL = GR. ACC.

NO.	(1)	(2)	(3)	(4)	(5)	(6)	(7)	(8)	(9)	(10)
490	1	0	0	0	0	0	3	0	1	1
500	0	0	0	1	-2	3	0	1	1	0
510	0	3	0	1	0	0	0	1	1	0
520	-2	0	1	1	0	1	1	2	0	1
530	3	0	0	2	1	1	-1	0	0	0
540	2	1	2	1	0	1	0	0	0	2
550	0	1	0	1	0	1	0	1	0	0
560	3	1	3	0	1	0	0	1	0	2
570	0	1	1	0	1	0	1	1	0	-1
580	0	0	1	0	0	1	1	1	0	0
590	0	0	0	1	1	0	1	1	2	0
600	0	1	1	3	2	1	0	0	0	0
610	0	0	1	0	2	0	0	0	1	0
620	1	0	1	0	2	0	0	0	0	5
630	-2	0	1	0	2	0	0	0	0	0
640	4	0	0	-1	2	1	0	0	1	1
650	1	2	2	0	1	2	1	0	1	0
660	0	-2	0	0	1	0	1	0	0	3
670	0	0	0	1	0	0	1	0	1	0
680	2	0	1	1	1	1	0	0	1	0
690	0	1	1	0	0	2	1	0	0	1
700	0	1	1	0	0	1	0	0	0	1
710	0	1	1	0	0	0	0	3	-2	0
720	0	2	0	0	0	0	0	0	0	0
730	1	0	1	1	0	0	0	2	0	1
740	-2	2	1	0	0	1	0	2	0	1
750	1	1	0	0	0	0	0	0	1	0
760	1	-2	0	1	1	0	0	0	1	1
770	3	0	1	0	2	1	0	1	2	3
780	0	3	0	2	2	1	0	1	0	0
790	2	0	1	0	0	1	0	1	0	1
800	0	0	1	0	0	0	0	0	0	0
810	0	1	2	0	-2	0	1	-2	0	0
820	2	1	0	0	2	2	0	0	1	1
830	2	0	0	0	0	0	0	2	1	0
840	0	3	0	0	0	0	1	0	1	1
850	1	1	0	0	1	1	1	3	1	1
860	1	1	1	0	0	0	0	0	0	0
870	0	0	1	0	0	0	0	1	0	0
880	1	0	0	1	0	0	0	0	-1	-4
890	0	1	0	0	0	0	1	2	0	0
900	2	1	1	0	0	0	0	0	-4	0
910	-2	-2	0	-4	-3	-3	0	0	0	1
920	0	0	0	3	-2	-5	0	2	0	1
930	0	0	0	-2	-2	-5	-3	0	0	0
940	0	3	2	3	0	0	0	-3	5	5
950	2	3	0	4	0	0	-2	0	0	0
960	1	-2	-4	-2	0	0	2	10	6	6
970	6	5	0	0	0	-2	-5	-9	-10	-19
980	-10	-7	-4	-7	-12	-19	-19	-9	-2	12
990	19	14	13	13	12	17	20	20	16	7
1000	0	-6	-8	-13	-19	-19	-13	-19	-19	-19
1010	-19	-19	-21	-25	-24	-10	-22	31	19	31
1020	37	43	51	50	42	51	26	31	37	37

TO BE CONTINUED

CONTINUED (F-95) E335

NO.	(1)	(2)	(3)	(4)	(5)	(6)	(7)	(8)	(9)	(10)
1030	32	20	10	-5	-14	-20	-29	-40	-43	-48
1040	-65	-77	-68	-64	-19	12	25	20	19	16
1050	11	10	12	20	35	44	36	20	12	3
1060	0	0	8	11	-1	-23	-48	-66	-66	-50
1070	-27	-7	4	10	12	15	10	10	0	6
1080	16	20	20	15	12	11	10	4	1	-6
1090	-9	-12	-14	-10	-19	-10	-12	9	12	9
1100	2	-4	-19	-27	-28	-27	-28	-29	-24	-7
1110	0	3	-3	-2	19	44	35	44	20	10
1120	0	10	10	-2	-10	-6	1	0	-5	-19
1130	-23	-24	-9	4	0	-8	1	1	0	-2
1140	-22	-27	-19	5	17	17	6	-4	-5	0
1150	10	12	20	35	44	52	46	29	12	5
1160	15	34	50	57	49	35	19	6	-2	-6
1170	-2	-4	-19	-29	-42	-52	-59	-64	-68	-59
1180	-58	-58	-59	-58	-42	-20	76	119	143	119
1190	-19	4	19	70	42	76	119	151	143	119
1200	105	90	77	73	75	72	58	34	0	-33
1210	-71	-93	-87	-78	-82	-88	-68	-68	-39	-9
1220	12	29	49	68	75	59	39	0	-27	-46
1230	-61	-73	-67	-19	-3	-12	-30	-37	-39	-39
1240	-34	-23	0	20	40	47	47	51	59	79
1250	95	92	71	67	20	0	-24	-60	-83	-86
1260	-65	-38	-22	-23	-21	-2	19	41	57	72
1270	77	59	30	10	5	10	10	0	-19	-46
1280	-71	-87	-98	-83	-58	-39	-24	-29	-31	-24
1290	-2	11	14	2	-11	-19	-19	-8	0	0
1300	5	18	48	72	79	59	59	69	66	66
1310	58	49	47	35	25	10	-2	-8	-82	-84
1320	-69	-48	-31	-11	3	6	2	-4	-5	2
1330	20	43	43	25	5	-2	-5	-10	-20	-44
1340	-54	-44	-19	5	17	20	31	52	71	77
1350	77	73	59	55	50	47	32	14	-4	-22
1360	-58	-81	-100	-108	-112	-115	-121	-118	-102	-76
1370	-39	2	37	55	64	88	118	138	148	146
1380	137	111	86	57	36	11	-21	-50	-58	-48
1390	-47	-58	-61	-58	-31	0	19	27	5	-27
1400	-58	-77	-87	-98	-92	-78	-62	-68	-85	-104
1410	-99	-61	-10	39	68	78	78	70	65	64
1420	71	73	59	46	38	34	35	35	41	58
1430	73	81	73	59	43	36	29	17	-2	-39
1440	-49	-63	-63	-67	-78	-78	-64	-42	-30	-55
1450	-47	-44	-19	1	10	7	-4	-14	-10	-8
1460	-17	-20	-20	-19	-20	-58	-106	-137	-137	-115
1470	-84	-64	-48	-31	-5	19	37	42	58	84
1480	119	138	138	138	138	136	127	91	59	42
1490	42	44	51	56	54	51	44	37	20	-5
1500	-39	-66	-82	-99	-114	-125	-137	-142	-143	-130
1510	-111	-103	-99	-88	-64	-24	20	52	59	59
1520	57	47	33	18	9	13	26	39	46	34
1530	30	39	34	64	67	66	65	57	46	40
1540	45	46	49	59	80	85	91	105	99	73
1550	20	-10	-34	-39	-20	-5	-11	-49	-100	-137
1560	-152	-132	-99	-58	-19	10	16	14	11	0

TO BE CONTINUED

CONTINUED (F-95) E335

NO.	(1)	(2)	(3)	(4)	(5)	(6)	(7)	(8)	(9)	(10)
1570	7	7	4	-7	-28	-51	-71	-86	-98	-103
1580	-103	-82	-49	-19	11	20	18	17	7	1
1590	-5	2	27	72	110	124	119	111	110	114
1600	118	118	113	99	89	76	59	52	-4	-39
1610	-62	-80	-104	-120	-127	-130	-131	-137	-127	-115
1620	98	-69	-44	-51	-54	-47	-58	-71	-84	-56
1630	-73	-48	-28	-8	0	2	9	20	39	56
1640	75	91	113	136	153	168	178	178	165	146
1650	121	99	88	80	71	53	20	-5	-19	-21
1660	-24	-34	-51	-69	-90	-101	-120	-143	-157	-156
1670	-148	-141	-132	-111	-93	-63	-26	11	45	59
1680	69	85	97	96	79	46	12	1	14	35
1690	41	33	20	10	9	16	20	20	20	11
1700	8	0	-20	-40	-44	-34	-20	-22	-32	-44
1710	-58	-65	-61	-34	-4	14	32	41	46	49
1720	54	59	59	59	53	32	5	-19	-31	-38
1730	-44	-39	-40	-49	-58	-36	-19	2	14	18
1740	32	59	91	99	91	69	49	38	28	10
1750	-5	6	8	20	39	59	73	59	58	45
1760	20	14	10	18	19	16	0	-24	-49	-58
1770	-51	-49	-58	-64	-73	-82	-88	-98	-88	-84
1780	-53	-23	-4	5	20	35	52	68	78	79
1790	79	78	74	57	35	17	-4	-21	-35	-58
1800	-86	-118	-131	-129	-114	-100	-81	-48	-6	31
1810	59	76	78	89	99	96	75	48	30	8
1820	-19	-37	-62	-68	-58	-24	0	16	2	-19
1830	-21	-14	-1	-27	-24	-7	10	19	20	27
1840	16	4	1	6	15	26	39	53	57	54
1850	54	57	54	39	53	69	69	59	42	29
1860	16	18	20	35	53	69	69	59	42	29
1870	14	5	10	0	-13	-19	-10	0	-5	-5
1880	-23	-48	-70	-90	-107	-108	-86	-58	-14	12
1890	27	30	37	54	78	94	92	71	48	27
1900	5	-24	-59	-86	-108	-119	-115	-101	-82	-60
1910	-44	-25	-9	6	20	48	75	91	97	99
1920	99	98	91	78	59	55	54	52	50	32
1930	-4	-47	-70	-69	-58	-34	-27	-39	-66	-98
1940	-122	-137	-137	-124	-111	-132	-150	-177	-196	-196
1950	-220	-261	-256	-240	-250	-191	-167	-160	-157	-157
1960	-167	-184	-206	-219	-221	-221	-227	-237	-256	-263
1970	-270	-273	-257	-259	-198	-115	-79	-49	-28	-48
1980	-19	-4	8	20	35	37	30	29	25	28
1990	85	132	177	222	265	296	328	348	358	372
2000	375	375	367	350	325	296	291	276	256	252
2010	209	192	161	109	50	-19	-63	-89	-105	-118
2020	-128	-137	-143	-150	-154	-160	-163	-168	-169	-177
2030	-179	-179	-177	-161	-147	-137	-108	-74	-31	16
2040	65	102	133	162	178	163	131	95	67	67
2050	45	12	-37	-98	-157	-216	-269	-315	-346	-375
2060	-394	-414	-424	-420	-393	-425	-475	-515	-546	-588
2070	0	91	190	290	393	492	586	669	759	766
2080	797	819	833	834	829	819	795	754	692	613
2090	522	426	329	237	151	59	-26	-115	-187	-266
2100	-324	-359	-360	-359	-250	-204	-151	-98	-58	-58

TO BE CONTINUED

NO.	(1)	(2)	(3)	(4)	(5)	(6)	(7)	(8)	(9)	(10)	(1)	(2)	(3)	(4)	(5)	(6)	(7)	(8)	(9)	(10)	
2110	-27	-7	-19	-43	-77	-98	-108	-105	-98	-79	2650	296	333	430	489	544	588	610	610	601	
2120	-65	-58	-48	-44	-39	-22	-3	12	15	7	2660	573	533	521	486	447	394	336	296	268	
2130	-9	-19	-6	-6	-19	-12	8	35	59	88	2670	195	137	89	35	-24	-82	-140	-202	-256	
2140	129	191	262	311	321	305	286	270	255	242	2680	-311	-330	-346	-354	-355	-342	-335	-325	-305	
2150	231	217	203	178	164	133	138	108	74	20	2690	-262	-239	-220	-216	-216	-205	-205	-225	-221	
2160	-48	-143	-256	-364	-463	-541	-594	-636	-671	-691	2700	-280	-305	-324	-335	-284	-183	-87	-10	59	
2170	-681	-660	-639	-618	-590	-572	-563	-572	-592	-591	2710	166	234	273	278	274	237	209	188	178	
2180	-375	-544	-506	-473	-447	-414	-339	-241	-115	20	2720	395	409	389	333	138	156	164	168	162	
2190	159	316	498	691	878	1043	1166	1260	1306	1307	2730	149	133	153	135	-27	-110	-187	-256	315	
2200	1259	1175	1082	981	864	716	534	335	127	-78	2740	138	106	43	-21	-44	-376	-299	-246	-205	
2210	-356	-381	-493	-581	-651	-696	-704	-701	-682	-634	2750	-414	-439	-438	-455	-441	-376	-266	-219	-146	
2220	-591	-373	-561	-333	-397	-644	-423	-384	-361	-348	2760	-177	-165	-185	-186	-221	-245	-256	-219	-146	
2230	-360	-381	-366	-346	-335	-288	-236	-168	-98	-20	2770	37	123	216	301	375	442	486	504	494	
2240	53	148	242	308	367	404	415	432	444	454	2780	435	352	256	148	59	14	-9	-10	0	
2250	451	429	400	375	361	359	286	244	217	211	2790	30	35	27	1	-58	-140	-217	-296	-358	
2260	217	252	288	317	309	296	272	248	238	240	2800	-478	-533	-561	-567	-541	-494	-434	-360	-278	
2270	239	215	158	85	0	-83	-150	-206	-281	-356	2810	-165	-137	-102	-67	-29	14	51	82	116	
2280	-633	-511	-591	-651	-697	-739	-755	-738	-691	-616	2820	178	228	287	348	414	472	518	556	592	
2290	-544	-454	-352	-291	-232	-133	-59	582	493	445	2830	671	703	708	677	624	558	481	396	310	
2300	367	455	515	550	535	584	562	493	445	427	2840	138	51	-24	-90	-146	-179	-194	-199	-216	
2310	434	454	465	425	333	209	88	7	-35	-48	2850	-268	-281	-285	-281	-276	-283	-300	-338	-383	
2320	-42	-23	-8	-6	-19	-19	0	20	31	39	2860	-454	-468	-468	-454	-422	-381	-338	-283	-228	
2330	31	-4	-58	-103	-158	-218	-299	-391	-455	-497	2870	-180	-177	-153	-123	-82	-49	-9	49	112	
2340	-502	-471	-454	-424	-389	-350	-285	-225	-166	-66	2880	185	211	240	253	250	239	232	217	217	
2350	32	148	253	343	425	485	491	481	446	375	2890	203	170	138	128	138	173	214	256	296	
2360	306	236	158	90	42	4	-19	-19	-20	0	2900	380	408	423	408	367	288	170	41	-98	
2370	24	59	109	158	197	216	208	165	89	-10	2910	-320	-397	-456	-493	-513	-523	-522	-508	-469	
2380	-92	-163	-229	-281	-329	-368	-400	-414	-403	-388	2920	-358	-267	-185	-118	-55	6	54	78	83	
2390	350	266	163	-63	19	85	138	205	275	326	2930	90	99	126	157	199	252	296	329	359	
2400	361	372	350	309	248	178	119	59	0	-63	2940	408	415	415	401	373	345	308	257	200	
2410	-116	-158	-191	-201	-187	-147	-106	-67	-49	-49	2950	91	41	-10	-65	-119	-172	-220	-264	-297	
2420	-52	-60	-72	-89	-103	-131	-162	-168	-187	-204	2960	-360	-385	-414	-426	-431	-433	-434	-426	-400	
2430	-223	-219	-185	-144	-115	-88	-101	-111	-113	-106	2970	-303	-256	-202	-149	-98	-61	-22	11	39	
2440	-93	-61	-19	17	39	35	14	-19	-19	8	2980	76	95	115	137	152	157	162	178	205	
2450	56	115	169	215	256	286	296	296	303	305	2990	236	240	250	253	249	230	208	151	98	
2460	296	296	287	248	196	130	59	3	-43	-68	3000	29	11	0	-4	11	37	73	113	138	
2470	-68	-48	-19	1	6	-9	-38	-68	-81	-83	3010	159	158	160	169	174	177	174	158	137	
2480	-78	-66	-58	-29	0	39	84	130	175	197	3020	179	54	28	0	-27	-60	-103	-148	-187	
2490	194	176	161	153	138	105	50	-5	-48	-90	3030	-242	-267	-296	-303	-288	-278	-262	-234	-217	
2500	-113	-137	-143	-126	-108	-106	-120	-123	-108	-63	3040	-140	-98	-80	-66	-38	2	20	42	52	
2510	-4	44	73	79	78	69	59	71	84	99	3050	5	0	-85	-2	5	-2	-3	2	19	
2520	106	99	79	59	52	40	6	-46	-105	-163	3060	35	48	57	59	65	73	77	74	57	
2530	-212	-237	-246	-256	-256	-263	-279	-296	-305	-314	3070	42	39	48	52	70	97	116	137	153	
2540	-312	-301	-273	-232	-157	-100	-62	-39	-24	-6	3080	186	200	217	226	207	178	162	138	99	52
2550	22	50	69	73	64	39	9	-59	-99	-129	3090	-2	-53	-107	-157	-199	-237	-267	-284	-300	
2560	-158	-172	-168	-140	-98	-40	7	39	39	20	3100	-320	-335	-335	-316	-284	-244	-204	-163	-126	
2570	6	0	5	35	72	99	119	113	89	58	3110	-72	-58	-42	-29	-19	-2	12	34	54	
2580	32	18	20	32	40	43	41	31	13	-19	3120	59	70	82	98	116	133	151	173	194	
2590	-48	-78	-89	-98	-99	-98	-79	-69	-66	-65	3130	237	256	273	278	262	237	198	160	113	
2600	-58	-37	-4	37	76	113	155	187	216	242	3140	-13	-62	-111	-160	-203	-240	-267	-288	-301	
2610	257	280	308	333	342	346	335	323	294	257	3150	-326	-329	-321	-301	-259	-207	-147	-85	-22	
2620	210	149	79	0	-62	-131	-193	-247	-296	-342	3160	92	158	217	276	319	333	344	336	307	
2630	-382	-431	-472	-502	-522	-533	-521	-504	-472	-418	3170	195	135	84	52	20	-19	-58	-66	-67	
2640	-360	-301	-245	-191	-137	-69	-4	74	152	226	3180	-58	-44	-30	-19	-14	-2	20	51	65	

TO BE CONTINUED

TO BE CONTINUED

CONTINUED(F-95

E335)

CONTINUED(F-95

E335)

NO.	(1)	(2)	(3)	(4)	(5)	(6)	(7)	(8)	(9)	(10)	(11)	(12)	(13)	(14)	(15)	(16)	(17)	(18)	(19)	(20)	
3190	59	31	5	-10	-19	-7	-7	-9	-21	-28	3730	36	25	0	-25	-46	-75	-104	-128	-152	-167
3200	-21	5	54	110	173	228	272	304	333	366	3740	-170	-181	-190	-194	-197	-197	-197	-177	-145	-118
3210	375	361	319	257	195	131	64	-5	-77	-197	3750	-86	-52	-19	19	54	86	112	130	146	157
3220	-134	-177	-200	-217	-221	-205	-185	-177	-177	-177	3760	190	202	207	217	214	196	170	161	152	152
3230	-168	-157	-151	-143	-130	-118	-100	-78	-44	-13	3770	130	111	85	57	46	37	15	-19	-41	-68
3240	0	11	4	-4	0	-4	6	-13	-14	-19	3780	-98	-103	-108	-115	-120	-120	-120	-115	-111	-107
3250	-31	-44	-58	-58	-53	-40	-24	3	20	34	3790	-105	-93	-78	-59	-41	-30	-25	-26	-28	-36
3260	37	24	9	-19	-35	-40	-34	-19	-19	-24	3800	-36	-28	-19	10	31	41	49	54	59	54
3270	-29	-30	-24	0	32	54	71	79	92	99	3810	71	74	89	86	74	59	51	38	39	54
3280	96	89	59	30	-4	-40	-79	-111	-138	-158	3820	65	86	104	113	127	152	170	187	200	198
3290	-178	-178	-178	-177	-178	-178	-178	-178	-178	-178	3830	202	208	210	210	217	224	227	227	215	195
3300	10	42	71	97	110	118	138	151	138	131	3840	178	160	138	136	121	94	59	33	2	-39
3310	127	121	113	111	128	99	98	99	116	127	3850	-58	-67	-82	-98	-123	-160	-177	-177	-190	-197
3320	155	137	138	148	152	153	155	168	187	197	3860	-199	-202	-195	-161	-122	-103	-81	-58	-34	-21
3330	198	189	168	136	103	64	44	29	17	0	3870	-19	-13	-34	-44	-48	-58	-73	-84	-84	-84
3340	-2	-14	-20	-16	-11	-6	13	36	50	57	3880	103	104	105	98	78	-62	-41	-24	-19	-19
3350	57	47	44	49	45	32	8	-20	-52	-73	3890	-27	-43	-67	-100	-137	-178	-227	-270	-306	-335
3360	-99	-119	-137	-137	-137	-125	-131	-139	-145	-145	3900	365	348	342	329	307	282	256	203	157	112
3370	-155	-162	-180	-206	-237	-233	-305	-335	-349	-363	3910	64	27	6	42	75	96	125	148	161	178
3380	-368	-363	-348	-320	-288	-248	-199	-142	-98	-48	3920	205	228	252	274	286	295	296	281	270	257
3390	-19	20	46	59	59	44	20	5	-12	-19	3930	236	215	192	154	129	99	73	44	19	-19
3400	-14	5	31	59	93	122	163	201	244	279	3940	-58	-72	-98	-103	-99	-100	-104	-104	-111	-120
3410	295	286	257	217	178	138	104	72	41	19	3950	119	123	125	123	137	147	156	168	179	184
3420	0	-2	-2	9	27	52	80	104	118	119	3960	-178	-177	-163	-149	-141	-126	-107	-91	-68	-40
3430	113	98	71	32	430	-80	-60	-65	-67	-73	3970	173	177	163	149	115	133	150	169	202	227
3440	-69	-66	-59	-42	-20	7	41	74	99	139	3980	243	257	263	269	262	252	241	228	207	178
3450	132	119	96	69	35	-2	-37	-73	-108	-137	3990	153	126	106	90	76	59	52	46	42	44
3460	-156	-158	-152	-137	-109	-78	-58	-29	-8	11	4000	46	45	38	20	15	0	-9	-20	-31	-48
3470	39	57	69	64	52	27	12	-2	-19	-28	4010	-63	-74	-86	-98	-98	-89	-80	-71	-60	-58
3480	-43	-65	-84	-99	-103	-102	-98	-88	-83	-86	4020	-50	-42	-34	-32	-30	-34	-29	-11	0	0
3490	-88	-98	-87	-83	-72	-59	-44	-27	-11	0	4030	20	39	53	65	77	89	99	98	86	86
3500	5	5	5	-4	-19	-24	-25	-29	-34	-41	4040	74	49	19	7	-35	-59	-87	-123	-156	-192
3510	-65	-74	-90	-99	-98	-98	-102	-118	-137	-149	4050	-221	-244	-257	-265	-264	-260	-244	-17	-182	-144
3520	-161	-168	-178	-181	-179	-162	-142	-121	-106	-87	4060	-108	-67	-19	30	59	74	76	75	96	131
3530	-64	-29	10	52	94	131	166	190	212	228	4070	161	172	188	203	210	217	231	231	229	235
3540	236	246	252	256	252	242	231	215	204	186	4080	228	209	190	160	122	91	59	29	6	-19
3550	171	153	137	118	98	79	53	29	5	19	4090	-31	-31	-36	-40	-36	-44	-58	-59	-67	-77
3560	-32	-51	-69	-83	-93	-101	-111	-120	-131	-137	4100	-83	-81	-79	-70	-62	-59	-52	-48	-58	-62
3570	131	124	118	117	121	137	141	133	140	154	4110	-69	-79	-98	-88	-99	-117	-139	-162	-185	-200
3580	-145	-130	-118	-98	78	48	10	36	84	124	4120	-216	-225	-231	-226	-210	-184	-155	-122	-98	-71
3590	148	167	178	183	191	178	178	173	168	154	4130	-47	-27	-19	5	20	39	59	81	95	109
3600	136	113	87	59	39	23	0	-19	-36	-58	4140	120	130	133	136	129	118	111	99	95	90
3610	-73	-98	-107	-112	-103	-90	-78	-62	-60	-60	4150	76	59	48	32	15	0	-10	-27	-41	-58
3620	-46	-26	7	39	59	84	99	118	125	128	4160	-70	-82	-98	-98	-101	-101	-99	-98	-86	-72
3630	138	145	149	138	138	130	119	106	76	48	4170	-53	-28	-14	5	12	26	39	53	73	96
3640	39	19	-4	-19	-39	-58	-58	-60	-64	-68	4180	115	136	157	168	178	202	217	236	254	267
3650	-72	-78	-84	-79	-76	-77	-81	-81	-86	-99	4190	274	287	294	286	272	242	206	169	135	99
3660	-110	-118	-122	-114	-98	-80	-60	-24	0	16	4200	71	48	20	-6	-30	-61	-99	-126	-152	-178
3670	51	59	75	85	95	99	98	83	59	37	4210	-198	-217	-229	-237	-256	-258	-265	-270	-275	-270
3680	0	-19	-39	-63	-98	-124	-142	-147	-150	-145	4220	-257	-240	-216	-181	-150	-123	-98	-82	-64	-53
3690	-126	-110	-99	-83	-71	-66	-63	-62	-58	-50	4230	-41	-25	-9	0	20	36	54	74	97	121
3700	-58	-59	-48	-44	-29	-20	-2	14	36	58	4240	153	178	213	241	257	275	284	284	280	262
3710	76	88	96	111	127	137	138	126	115	110	4250	236	205	165	123	79	35	-5	-50	-98	-137
3720	108	109	110	112	99	85	71	53	53	45	4260	-166	-197	-216	-231	-236	-228	-218	-198	-181	-157

TO BE CONTINUED

TO BE CONTINUED

NO.	(1)	(2)	(3)	(4)	(5)	(6)	(7)	(8)	(9)	(10)
4270	-137	-106	-86	-59	-39	-20	0	17	34	45
4280	55	59	79	91	106	118	126	123	119	111
4290	96	84	69	49	30	2	-25	-51	-75	-98
4300	-104	-107	-98	-73	-52	-31	-9	0	20	40
4310	49	57	59	58	53	42	20	6	-8	-28
4320	-68	-68	-87	-105	-123	-138	-144	-151	-158	-165
4330	-177	-177	-177	-162	-146	-121	-98	-78	-59	-44
4340	-39	-20	0	27	57	90	117	143	165	186
4350	211	233	253	274	284	281	283	285	291	291
4360	286	257	236	207	187	162	133	98	54	7
4370	-34	-67	-98	-119	-141	-166	-192	-220	-247	-269
4380	-285	-298	-299	-296	-275	-256	-235	-194	-155	-113
4390	78	39	2	42	82	122	153	178	203	215
4400	217	217	215	212	212	211	205	198	185	170
4410	148	123	99	82	59	39	20	0	-6	-22
4420	-36	-46	-58	-59	-61	-59	-61	-61	-61	-62
4430	-65	-65	-66	-66	-67	-63	-64	-71	-74	-78
4440	-83	-84	-82	-86	-98	-103	-104	-102	-92	-80
4450	-78	-65	-47	-34	-24	-21	-10	0	15	34
4460	57	81	104	120	131	138	149	157	157	152
4470	138	126	111	94	74	53	20	-2	-28	-50
4480	-70	-98	-106	-126	-144	-157	-167	-177	-178	-178
4490	-177	-168	-162	-155	-144	-130	-118	-104	-89	-78
4500	-63	-58	-39	-26	-19	-7	-4	1	3	2
4510	-4	7	1	19	20	23	29	42	50	42
4520	52	59	77	86	94	96	96	91	88	88
4530	87	87	81	73	65	59	51	46	38	32
4540	20	12	2	-9	-21	-30	-44	-51	-58	-64
4550	-66	-63	-66	-63	-65	-61	-52	-39	-21	-2
4560	10	17	20	30	37	47	52	59	59	59
4570	59	59	55	54	51	48	37	27	19	14
4580	11	0	-2	-8	-19	-21	-22	-22	-23	-23
4590	-23	-28	-36	-46	-58	-63	-73	-84	-98	-100
4600	-105	-102	-98	-88	-78	-61	-49	-39	-30	-32
4610	-27	-22	-19	-8	0	15	31	48	70	89
4620	109	125	138	156	172	177	178	173	164	150
4630	136	116	94	74	58	39	29	20	17	19
4640	20	30	39	51	59	59	56	47	39	32
4650	28	19	16	11	10	8	5	10	12	12
4660	19	20	18	13	8	0	-6	-19	-24	-39
4670	-47	-58	-60	-67	-71	-73	-73	-73	-78	-81
4680	-84	-89	-98	-104	-116	-128	-137	-141	-140	-137
4690	-128	-116	-102	-78	-58	-26	-4	18	35	47
4700	56	59	69	69	65	57	46	31	20	9
4710	6	9	14	14	13	13	12	11	10	7
4720	7	3	0	-4	-10	-19	-19	-19	-19	-24
4730	-27	-28	-27	-24	-19	-19	-19	-19	-13	-13
4740	-15	-19	-21	-25	-29	-34	-38	-47	-58	-59
4750	-58	-58	-48	-39	-27	-19	6	20	36	52
4760	64	76	85	90	95	98	98	99	111	113
4770	117	121	120	118	119	121	125	132	133	131
4780	123	112	96	86	76	59	46	26	0	-23
4790	-66	-66	-87	-106	-126	-145	-168	-189	-205	-219
4800	-227	-227	-224	-216	-205	-192	-178	-159	-138	-117

TO BE CONTINUED

TO BE CONTINUED

CONTINUED (F-95) E335)										CONTINUED (F-95) E335)											
NO.	(1)	(2)	(3)	(4)	(5)	(6)	(7)	(8)	(9)	(10)	NO.	(1)	(2)	(3)	(4)	(5)	(6)	(7)	(8)	(9)	(10)
5350	99	106	115	128	138	150	148	152	143	132	5890	-36	-34	-31	-27	-22	-19	-9	-2	0	7
5360	123	98	78	51	20	-2	-27	-48	-68	-89	5900	14	20	29	39	46	55	59	72	78	85
5370	-104	-117	-128	-137	-142	-142	-143	-137	-129	-123	5910	87	89	89	81	78	71	59	59	54	49
5380	-113	-102	-93	-81	-69	-58	-44	-27	-9	10	5920	49	55	54	59	66	73	78	83	84	89
5390	32	52	72	93	111	130	145	159	171	176	5930	89	89	87	84	78	72	59	58	52	44
5400	178	178	177	168	159	146	129	99	81	59	5940	39	35	30	24	14	10	0	-6	-12	-19
5410	40	17	1	-19	-30	-58	-69	-82	-98	-102	5950	-22	-26	-31	-29	-31	-32	-32	-39	-38	-39
5420	-108	-113	-114	-116	-116	-118	-113	-109	-105	-98	5960	-36	-32	-29	-24	-24	-19	-19	-19	-19	-10
5430	-88	-82	-76	-65	-53	-39	-23	-8	0	12	5970	-9	-9	-5	-4	-4	-4	-10	-9	-19	-19
5440	15	16	14	10	9	5	-2	-10	-20	-20	5980	-19	-19	-19	-10	-7	0	1	1	6	5
5450	-27	-34	-37	-40	-37	-39	-34	-32	-29	-24	5990	8	10	5	7	3	0	0	-2	0	3
5460	-19	-19	-16	-19	-14	-19	-19	-24	-24	-27											
5470	-28	-30	-29	-30	-27	-26	-26	-26	-27	-28											
5480	-30	-34	-41	-48	-49	-48	-48	-44	-40	-39											
5490	-36	-32	-26	-22	-19	-7	0	0	8	7											
5500	0	-2	-7	-19	-19	-19	-19	-19	-19	-19											
5510	-19	-19	-19	-19	-24	-24	-24	-24	-27	-27											
5520	-33	-41	-48	-61	-63	-67	-71	-69	-63	-63											
5530	-63	-58	-46	-36	-28	-21	-7	-2	7	12											
5540	20	34	42	52	59	70	82	92	98	98											
5550	99	99	98	95	91	86	77	64	52	45											
5560	39	37	41	44	48	49	49	47	44	42											
5570	37	29	20	15	8	1	1	-2	-7	-7											
5580	-19	-10	-8	-4	0	4	7	5	3	0											
5590	-5	-9	-19	-19	-24	-24	-26	-25	-20	-19											
5600	-9	-3	0	10	19	30	38	41	44	44											
5610	44	39	32	29	27	26	20	30	34	36											
5620	35	39	41	45	44	46	42	37	29	20											
5630	10	-2	-14	-29	-47	-66	-85	-103	-118	-126											
5640	-137	-138	-142	-146	-147	-147	-144	-140	-137	-125											
5650	-112	-99	-88	-76	-61	-48	-32	-19	-7	0											
5660	14	20	31	39	45	50	54	59	66	69											
5670	74	80	81	81	81	80	80	84	91	98											
5680	99	108	111	115	114	113	108	99	92	78											
5690	65	49	40	28	19	9	1	-8	-11	-11											
5700	-11	-8	-6	-7	-5	-7	-9	-14	-19	-19											
5710	-19	-9	-10	-7	-2	2	12	26	38	50											
5720	56	59	59	68	70	69	66	59	56	44											
5730	34	20	15	7	0	-7	-19	-27	-38	-44											
5740	-49	-53	-58	-62	-67	-74	-76	-81	-86	-87											
5750	-88	-90	-87	-86	-81	-78	-72	-66	-63	-58											
5760	-52	-41	-31	-23	-19	-8	2	15	28	39											
5770	49	58	59	70	74	81	85	90	95	98											
5780	99	108	111	117	121	125	131	131	136	138											
5790	138	136	130	118	106	94	79	64	52	37											
5800	20	8	-4	-19	-34	-48	-61	-70	-83	-90											
5810	-100	-111	-119	-125	-140	-155	-151	-147	-155	-151											
5820	-140	-138	-129	-115	-102	-87	-76	-63	-48	-41											
5830	-35	-29	-19	-7	1	10	14	19	31	39											
5840	48	57	59	59	59	59	66	59	56	53											
5850	39	34	20	15	9	0	-14	-25	-39	-44											
5860	-58	-62	-71	-79	-86	-89	-86	-83	-78	-78											
5870	-104	-103	-98	-98	-98	-89	-86	-83	-78	-78											
5880	-64	-59	-58	-54	-54	-54	-48	-44	-44	-40											

TO BE CONTINUED

END

RECORD = F-95 COMPONENT = UP STATION = YAMASHITA-F
 DATE AND TIME = 1987-12-17-11-8 TOTAL NUMBER OF DATA = 6000
 SAMPLING INTERVAL = 0.010 (SEC) SCAL = 0.10000
 SIGNAL = GR. ACC.

CONTINUED(F-95 UP)

NO.	(1)	(2)	(3)	(4)	(5)	(6)	(7)	(8)	(9)	(10)
490	-6	1	2	1	0	-1	-1	-1	0	1
500	0	2	0	0	-1	0	1	-1	-1	-1
510	-1	3	0	1	0	1	1	-1	-1	-1
520	1	1	3	-1	0	0	-1	0	-1	-1
530	3	0	-1	0	0	0	-1	0	-1	-1
540	-1	-1	1	0	0	-1	-1	-1	-1	-1
550	-2	-1	-1	0	2	2	0	2	-1	2
560	-1	-1	0	1	0	1	-1	-1	-1	-1
570	0	1	0	4	0	-1	-1	0	0	-1
580	-1	0	0	1	-1	2	-1	-1	-1	0
590	1	-1	0	-1	0	-1	0	-1	-1	1
600	-1	-1	3	-1	-1	-1	-1	-1	-1	-1
610	0	-1	-1	-1	-1	3	3	1	3	3
620	0	-1	-1	2	0	0	0	-1	0	0
630	-1	-1	-1	0	0	-1	-1	-1	-1	0
640	-1	-1	2	2	-4	-1	-1	7	-1	-1
650	-1	-1	2	-1	-1	-1	1	2	0	-1
660	0	-2	-1	0	3	2	3	5	3	3
670	3	-1	-1	-1	-1	0	0	0	-1	-1
680	3	-1	-1	-1	0	0	0	0	0	2
690	-1	3	2	0	-1	-1	0	0	2	-1
700	2	-1	0	2	0	-1	0	-1	0	0
710	-1	-1	0	1	0	0	-1	0	1	-2
720	2	0	-1	-1	-1	-1	-1	-1	-1	0
730	0	2	-1	-1	2	2	0	-1	0	2
740	-1	-1	0	0	-1	1	1	-1	0	-1
750	-1	1	-1	3	-1	-1	-1	-1	3	1
760	-1	0	0	-1	-1	1	0	0	-1	-1
770	-1	1	-1	2	-1	0	3	0	-1	-1
780	-1	3	2	-1	2	2	-1	3	-1	-1
790	2	-1	-1	-1	-1	0	0	-1	0	-1
800	-1	0	0	0	-1	0	-1	2	0	2
810	-1	-1	-1	1	-1	-1	0	0	1	-1
820	-1	2	5	-1	1	0	0	-1	3	-1
830	-1	-1	-3	-1	1	1	0	0	-1	0
840	-1	0	0	-1	-1	-3	-2	0	2	4
850	2	0	0	-1	-1	-1	0	0	-1	-1
860	-1	0	-1	2	-1	-1	-1	-1	0	-1
870	5	7	5	5	4	5	6	7	7	9
880	8	10	10	10	14	14	13	10	7	5
890	2	3	4	-1	-2	-4	-7	-6	-6	-4
900	-2	-2	-1	6	11	16	18	31	32	27
910	17	6	-1	-1	3	8	7	5	-3	-13
920	-13	2	10	18	30	18	8	3	15	29
930	37	29	8	-21	-27	-22	-21	-1	-1	-6
940	-21	-25	-24	-21	-10	-5	-1	-2	-31	-51
950	-23	-11	2	8	4	0	9	26	38	38
960	43	27	-3	-34	-48	-43	-28	-4	15	30
970	48	58	78	82	84	75	77	89	109	138
980	119	81	25	-24	-54	-52	-31	-40	-88	-88
990	-145	-180	-180	-141	-100	-69	-61	-65	-68	-65
1000	-61	-49	-41	-46	-61	-61	-61	-76	194	285
1010	296	261	188	102	25	-40	-81	-104	-123	-147
1020	-185	-211	-207	-150	-61	15	47	13	-61	-140

TO BE CONTINUED

CONTINUED (F-95)										CONTINUED (F-95)											
NO.	(1)	(2)	(3)	(4)	(5)	(6)	(7)	(8)	(9)	(10)	NO.	(1)	(2)	(3)	(4)	(5)	(6)	(7)	(8)	(9)	(10)
1030	-168	-121	5	152	251	261	177	70	-8	-12	1570	-26	-13	6	8	9	10	27	39	32	3
1040	46	116	109	109	16	-103	-195	-219	-180	-101	1580	-25	-19	-11	18	58	82	58	71	29	-50
1050	-37	-14	-30	-65	-86	-68	-32	-6	13	47	1590	-41	-13	-10	-10	-40	-74	-86	-71	-31	13
1060	94	137	176	186	154	86	5	-61	-91	-91	1600	56	80	85	68	27	-26	-62	-88	0	49
1070	-109	-110	-100	-71	-41	-12	-21	-21	-14	-14	1610	77	82	64	28	-11	-43	-71	-86	-91	-103
1080	-9	-9	-9	-2	18	53	63	36	41	41	1620	-102	-89	-56	9	49	55	37	48	81	133
1090	72	97	103	97	92	105	124	53	76	-1	1630	165	157	112	45	-28	-86	-117	-123	-100	-62
1100	-75	-111	-118	-106	-75	-42	-30	-68	-86	-120	1640	-30	-21	-8	-1	-4	-31	-61	-53	7	64
1110	-61	18	97	154	127	82	82	38	5	1	1650	148	205	216	174	84	21	-90	-109	-80	-43
1120	5	9	17	33	51	9	-74	-159	-213	1	1660	-25	-24	-21	-7	0	-16	-61	-112	-145	-130
1130	-180	-118	-39	33	58	39	-21	-75	-68	58	1670	-76	-10	39	57	57	46	28	27	67	148
1140	-21	34	80	97	97	74	35	17	26	58	1680	216	244	192	96	13	-24	-21	5	8	-22
1150	82	67	32	8	5	15	27	30	30	31	1690	-100	-130	-207	-149	-36	57	78	27	54	-115
1160	13	-33	-103	-147	-103	-30	-30	28	33	30	1700	-114	-42	64	137	156	102	13	-70	-106	-85
1170	-14	-165	-15	-70	18	97	114	58	-40	-128	1710	-6	65	84	39	-49	-130	-161	-144	-100	-53
1180	-156	-115	-21	112	192	201	158	111	77	47	1720	-41	-66	-105	-110	-49	43	114	121	67	-6
1190	-17	-100	-155	-168	-143	-95	-23	69	137	161	1730	-53	-61	9	114	189	194	123	7	-86	-115
1200	133	91	67	66	77	76	52	25	3	0	1740	-85	-12	58	97	3	18	-77	-154	-165	-105
1210	-21	-39	-42	-15	18	18	-25	-85	-128	-110	1750	-21	50	53	3	-61	-78	-51	18	92	159
1220	-61	1	57	107	148	137	82	18	0	29	1760	114	58	14	-11	-12	2	13	18	-1	-6
1230	75	92	68	4	-71	-141	-180	-164	-101	-2	1770	-81	-101	-78	-29	27	58	73	58	27	-37
1240	72	106	95	74	63	80	107	133	128	69	1780	-119	-188	-200	-149	-56	13	32	32	47	72
1250	-43	-152	-210	-180	-18	49	97	90	26	-49	1790	74	46	-5	-45	-56	-36	-21	-21	-29	-25
1260	-100	-93	-39	18	43	32	-3	-44	-69	-61	1800	-7	23	63	97	127	137	129	97	40	-16
1270	8	80	116	103	52	-39	-110	-156	-156	-109	1810	-41	-29	-1	18	52	94	123	107	45	-29
1280	-38	28	58	57	28	-8	-26	-17	8	17	1820	-86	-117	-114	-100	-75	-70	-61	-27	15	42
1290	0	-39	-67	-61	43	58	34	0	-4	0	1830	30	8	-2	-6	3	23	55	78	73	43
1300	18	47	55	54	72	116	156	169	148	95	1840	5	-25	-35	-21	13	49	76	91	86	51
1310	38	3	-13	-33	-68	-106	-140	-159	-170	-152	1850	3	-39	-59	-51	-31	-30	-46	-64	-68	-47
1320	-103	-40	10	69	119	157	177	188	167	117	1860	-21	18	69	114	132	117	93	73	58	53
1330	48	-25	-89	-126	-129	-107	-89	-83	-64	-21	1870	17	-17	-40	-36	8	58	81	43	-22	-103
1340	42	72	52	-6	-61	-78	-62	-34	-21	-40	1880	-180	222	-220	-181	-110	-38	18	63	107	153
1350	-94	-46	-159	-110	-29	50	88	85	70	70	1890	202	227	208	148	73	-1	-42	-50	-23	-1
1360	80	68	18	-43	-89	-101	-88	-73	-52	-23	1900	-71	-25	-54	-64	-48	-22	-1	-1	-1	7
1370	-1	2	6	40	102	165	191	164	97	31	1910	4	-23	-63	-101	-119	-105	-66	49	137	190
1380	-2	2	40	79	112	107	63	-2	-56	-61	1920	182	127	57	15	8	18	32	18	-3	-21
1390	-31	17	43	37	4	-21	-21	-16	15	-11	1930	-11	5	29	45	50	38	15	-21	-61	-108
1400	-21	-26	-51	-71	-66	-33	5	29	36	36	1940	-147	-165	-162	-130	-77	-7	58	107	121	94
1410	33	15	1	5	110	1410	107	57	-36	76	1950	49	6	-21	-24	-21	-7	-4	-16	-38	0
1420	-143	-231	-180	-90	-6	49	58	32	-21	-40	1960	-46	10	84	152	186	176	129	57	0	-32
1430	-61	-54	-6	38	53	18	-31	-48	-29	16	1970	-25	1	5	-2	-27	-29	-10	14	43	80
1440	65	93	96	90	79	60	-30	-106	-130	-100	1980	118	132	97	15	-80	-134	-169	-160	-115	-100
1450	-66	-46	-28	-2	26	53	67	63	58	77	1990	-100	-182	-119	-141	-155	-145	-108	-51	-4	-12
1460	115	137	125	75	4	-62	-100	-109	-81	-26	2000	-36	-36	-21	18	56	70	75	83	97	118
1470	39	85	107	112	94	58	18	-21	-48	-78	2010	159	156	205	253	268	236	167	89	34	-7
1480	-109	-140	-161	-161	-115	50	85	58	8	8	2020	-38	-51	-67	-88	-119	-154	-180	-180	-120	-41
1490	-43	-70	-69	-31	35	97	127	120	102	87	2030	25	44	28	14	15	18	15	10	-1	-5
1500	72	58	39	13	17	73	134	162	137	137	2040	-9	-21	-25	-41	-68	-21	25	40	-4	-4
1510	58	-21	-86	-123	-120	-76	-11	45	52	-9	2050	-100	-180	-219	-203	-153	-93	-66	-77	-123	-180
1520	-108	-180	-182	-119	-21	67	95	58	2	-53	2060	-210	-195	-140	-66	-11	14	18	4	-24	-28
1530	-77	-44	33	118	137	97	18	-33	-142	-147	2070	14	88	162	216	225	177	95	14	-25	-11
1540	-90	-24	-2	-4	-1	17	33	49	67	71	2080	18	58	87	87	70	50	38	42	47	58
1550	45	-1	-45	-85	-118	-119	-33	43	94	85	2090	70	82	88	88	77	69	54	42	43	58
1560	27	-30	-51	-22	32	69	70	42	9	-21	2100	75	50	-12	-73	-89	-61	-3	43	43	4

TO BE CONTINUED

TO BE CONTINUED

CONTINUED(F-95)

UP)

UP)

CONTINUED(F-95)

UP)

NO.	(1)	(2)	(3)	(4)	(5)	(6)	(7)	(8)	(9)	(10)
2110	-38	-44	-21	7	32	33	-1	-43	-80	-100
2120	-74	-36	-1	30	47	50	48	49	48	39
2130	23	9	10	34	58	68	58	46	18	-13
2140	-61	-87	-92	-61	-2	37	33	-11	-100	-168
2150	-200	-189	-157	-128	-103	-83	-61	-43	-23	4
2160	55	116	149	141	102	57	33	44	69	83
2170	84	96	121	152	188	206	206	192	146	92
2180	32	-26	-85	-125	-128	-100	-41	18	45	24
2190	-21	-46	-61	-61	-53	-51	-45	-39	-46	-68
2200	-81	-88	-81	-44	13	63	77	58	9	-80
2210	-159	-198	-185	-125	-63	-9	47	74	58	80
2220	19	176	226	256	291	292	209	102	17	-46
2230	-34	-35	-41	-49	-69	-103	-111	-83	-30	18
2240	58	49	14	-23	-66	-61	-35	-39	-47	-61
2250	-61	-50	-61	-81	-100	-116	-130	-119	-103	-100
2260	-105	-110	-131	-140	-108	-81	-30	-1	9	-10
2270	-41	-43	-21	14	67	134	192	241	291	330
2280	347	318	280	233	188	157	136	114	91	65
2290	39	3	-33	-45	-67	-71	-39	31	92	90
2300	53	18	-21	-74	-115	-145	-180	-207	-259	-310
2310	-318	-305	-285	-262	-244	-266	-309	-338	-299	-197
2320	-101	-11	90	164	199	215	206	185	188	215
2330	216	209	177	134	107	58	-7	-61	-86	-119
2340	113	-86	-78	-48	0	27	38	14	-35	-41
2350	-26	-4	9	29	65	126	188	190	128	72
2360	42	30	50	63	58	45	11	-35	-100	-147
2370	-154	-128	-91	-52	-10	18	27	18	15	18
2380	31	30	40	58	336	206	206	256	279	281
2390	276	216	149	88	34	-10	-60	-113	-154	-195
2400	-239	-265	-245	-239	-181	-83	9	58	58	16
2410	-46	-73	-47	-21	10	8	-21	-61	-80	-84
2420	-61	-16	32	52	18	-21	-43	-50	8	112
2430	198	243	246	195	117	42	-9	-21	-21	-25
2440	-51	-71	-101	-128	-145	-140	-107	-42	18	72
2450	97	97	72	30	-7	-34	-46	-61	-78	-113
2460	-149	-149	-111	-67	-36	-29	-50	-84	-100	-81
2470	-38	13	43	53	44	63	28	13	-1	-8
2480	-10	-13	-13	5	64	42	28	13	-1	-8
2490	82	137	193	209	192	149	107	68	36	18
2500	-1	-30	-80	-115	-128	-120	-101	-76	-61	-61
2510	-85	-114	-125	-103	-68	-40	-25	-8	5	18
2520	28	32	28	18	17	8	-6	-21	-26	-22
2530	-21	-11	3	37	63	85	94	79	45	17
2540	13	38	47	15	-47	-117	-159	-156	-106	-33
2550	30	58	56	31	17	18	18	3	-39	-94
2560	-152	-183	-180	-140	-66	4	48	55	37	15
2570	9	36	69	101	106	86	58	52	63	90
2580	124	137	137	117	69	18	-1	1	-11	-11
2590	-39	-26	-16	-44	-77	-100	-100	-74	-53	-45
2600	-39	-26	-1	18	32	42	58	82	97	105
2610	89	58	48	37	18	16	13	18	37	39
2620	18	-7	30	-61	-28	-1	18	17	-1	-8
2630	-10	-12	-13	-21	-29	-28	-21	-12	-10	-21
2640	-33	-61	-65	-70	-71	-71	-69	-52	-29	-6
2650	18	63	97	122	107	58	-4	-64	-91	-90
2660	-81	-85	-105	-105	-122	-110	-90	-64	-39	-21
2670	-16	-13	-7	9	38	58	52	17	-25	-74
2680	-101	-90	-45	-11	4	25	37	33	28	32
2690	44	69	97	136	177	209	224	216	216	226
2700	209	162	112	58	18	5	5	18	43	57
2710	33	-1	-21	0	26	9	-48	-110	-159	-190
2720	-222	-259	-399	-329	-346	-318	-281	-233	-188	-154
2730	-128	-101	-77	-51	-23	18	72	117	151	163
2740	176	214	208	188	186	171	154	169	166	157
2750	159	132	95	75	69	34	33	16	23	38
2760	34	15	-21	-41	-51	-43	-21	15	36	18
2770	-10	-47	-72	-75	-63	-44	-21	9	7	-21
2780	-39	-70	-110	-144	-180	-193	-194	-175	-145	-115
2790	-81	-49	-9	43	89	111	119	113	109	112
2800	112	108	96	77	64	67	77	92	96	97
2810	90	77	51	18	-6	-35	-64	-81	-84	-80
2820	-66	-48	-30	-7	17	43	58	58	48	23
2830	4	-4	-7	5	33	66	94	87	45	-6
2840	-41	-61	-68	-68	-66	-61	-10	-2	-21	-36
2850	-48	-48	-30	-21	-23	-37	-46	-48	-54	-64
2860	-78	-90	-104	-101	-80	-46	-2	48	97	143
2870	172	177	167	151	137	134	127	121	97	58
2880	10	-45	-85	-101	-103	-76	-61	-7	8	-1
2890	-26	-46	-61	-64	-52	-54	-67	-78	-84	-89
2900	-86	-68	-26	39	97	137	162	162	151	137
2910	114	92	116	129	122	94	18	-6	-21	-2
2920	33	81	116	129	122	94	57	30	16	5
2930	12	30	55	74	72	57	38	18	14	9
2940	8	-1	-1	-27	-60	-84	-89	-71	-36	-2
2950	18	32	18	0	-21	-21	-1	32	65	65
2960	45	39	18	14	0	-25	-38	-39	-42	-35
2970	-71	-85	-75	-78	-74	-74	-61	-38	-21	-1
2980	-2	3	16	32	43	36	-1	-47	-100	-113
2990	-100	-69	-40	-21	-21	-45	-69	-80	-78	-70
3000	-66	-73	-85	-100	-103	-101	-100	-86	-53	-12
3010	18	34	47	57	81	107	136	165	189	192
3020	196	177	152	132	117	107	108	97	76	72
3030	-1	-33	-61	-85	-86	-78	-61	-37	-21	-23
3040	-36	-47	-45	-37	-21	6	27	40	43	23
3050	-5	-41	-70	-80	-66	-41	-30	-48	-74	-100
3060	-120	-121	-101	-66	-39	-27	-47	-68	-78	-63
3070	-6	53	97	152	163	129	92	72	77	95
3080	128	151	166	110	68	35	24	12	-1	-6
3090	9	29	50	69	70	70	66	60	57	54
3100	53	50	37	15	-4	-11	-11	-2	17	40
3110	25	-8	-50	-88	-109	-128	-119	-128	-141	-165
3120	-190	-180	-154	-115	-72	-30	2	14	9	3
3130	-70	18	40	58	75	77	58	44	24	-1
3140	-29	-61	-70	-71	-74	-84	-100	-100	-81	-47
3150	-16	11	18	15	6	-2	8	33	76	130
3160	145	129	92	55	40	55	76	72	57	17
3170	-23	-48	-61	-52	-56	-10	-2	-21	-26	-21
3180	-7	8	25	33	32	16	-13	-45	-41	-45

TO BE CONTINUED

TO BE CONTINUED

CONTINUED(F-95)

UP)

CONTINUED(F-95)

UP)

NO.	(1)	(2)	(3)	(4)	(5)	(6)	(7)	(8)	(9)	(10)
3190	-21	2	-4	-36	-70	-103	-105	-81	-51	-31
3200	-23	-29	-44	-61	-73	-78	-68	-51	-36	-21
3210	0	23	52	76	94	97	104	97	101	90
3220	72	52	34	18	25	32	34	33	32	29
3230	25	18	5	3	7	13	17	11	0	6
3240	-6	-7	-14	-30	-49	-70	-77	-84	-90	-89
3250	-85	-76	-69	-63	-34	0	25	43	36	22
3260	4	-6	5	29	57	82	96	92	72	45
3270	57	36	4	-28	-52	-67	-72	-78	-83	-100
3280	-111	-107	-100	-72	-45	-21	15	42	52	72
3290	18	8	10	15	39	67	87	97	92	72
3300	49	29	18	17	18	18	13	6	-29	-47
3310	-61	-61	-48	-38	-32	-42	-66	-100	-116	-120
3320	-95	-61	-21	-2	-6	-26	-41	-35	-1	30
3330	57	66	81	52	41	38	35	18	2	-26
3340	-48	-66	-81	-86	-85	-76	-65	-61	-50	-46
3350	-33	-21	-16	-21	-8	4	18	33	37	30
3360	18	18	0	-22	-46	-63	-66	-61	-45	-35
3370	-33	-34	-39	-45	-41	-36	-26	-11	-3	-1
3380	-1	11	18	29	35	33	20	5	-6	-1
3390	9	25	33	32	18	15	10	13	11	3
3400	-6	-14	-28	-41	-40	-31	-12	5	18	18
3410	18	27	34	42	48	49	48	48	47	38
3420	34	43	68	102	132	137	134	134	134	134
3430	122	97	77	50	18	-22	-73	-110	-128	-118
3440	-104	-90	-88	-85	-76	-63	-46	-30	-21	-12
3450	-14	-25	-15	-3	-4	4	4	-8	-29	-61
3460	-73	-80	-75	-61	-41	-21	0	18	39	51
3470	53	46	40	40	50	53	49	33	16	9
3480	9	14	17	18	8	-4	-23	-35	-30	-21
3490	-2	0	3	17	35	51	57	54	44	37
3500	40	53	66	72	75	70	57	61	25	9
3510	-8	-24	-39	-51	-45	-26	-1	34	58	72
3520	80	77	72	63	54	41	18	14	8	-4
3530	-38	-70	-94	-109	-117	-125	-140	-140	-140	-140
3540	-130	-123	-101	-76	-61	-46	-43	-36	-26	-5
3550	14	18	32	38	47	57	69	67	66	57
3560	53	53	58	68	67	65	58	55	55	55
3570	35	47	35	18	23	18	17	18	30	35
3580	28	18	12	10	14	32	51	53	48	42
3590	38	29	15	8	17	27	34	38	34	34
3600	18	18	15	15	17	27	40	43	33	14
3610	0	-3	2	5	0	-21	-33	-39	-27	-16
3620	-17	-30	-47	-61	-62	-64	-61	-44	-28	-17
3630	-9	-21	-21	-21	-6	9	18	34	49	53
3640	58	49	47	55	67	67	81	85	84	82
3650	91	97	96	84	68	43	23	8	-7	-16
3660	-28	-31	-22	-61	-68	-69	-61	-34	-21	-21
3670	-21	-21	-22	-23	-26	-24	-29	-42	-53	-70
3680	-90	-111	-111	-101	-91	-85	-81	-62	-48	-41
3690	-25	-15	-1	9	18	18	25	27	35	57
3700	74	80	77	65	52	36	25	28	33	27
3710	27	38	43	36	18	10	-1	-8	-21	-11
3720	-6	-1	10	18	36	40	48	57	67	72

TO BE CONTINUED

TO BE CONTINUED

4270	84	77	74	70	58	50	36	14	-10	-34	18	25	24	26	18	15	5	-3	
4280	-61	-66	-75	-82	-73	-70	-64	-64	-48	-44	-21	-22	-21	-26	-38	-43	-48	-46	
4290	33	-23	-21	-21	-21	-21	-9	-21	-21	-21	-9	-1	-1	18	30	40	45	50	
4300	-21	-7	9	13	9	29	23	16	5	-12	43	40	36	38	34	14	18	27	
4310	-21	-15	-21	-21	-21	-23	-23	-23	-32	-46	-9	-7	-5	0	10	14	3	9	
4320	-50	-61	-49	-49	-39	-26	-13	-15	-13	-11	25	20	14	10	10	5	9	-11	
4330	-11	-6	4	14	23	28	18	9	-6	-7	10	16	14	9	8	-7	1	23	
4340	-21	-1	10	20	18	13	9	4	1	7	13	12	12	7	13	18	23	25	
4350	18	42	46	35	31	39	40	37	30	8	31	32	37	33	28	18	15	15	
4360	-6	-6	6	6	6	8	8	8	5	-5	13	8	8	14	15	18	17	14	
4370	-31	-48	-47	-39	-32	-26	-21	-21	-16	-21	9	10	13	17	18	18	18	15	
4380	-21	-14	-9	-1	5	-1	-1	-5	-21	-21	3	0	5	5	4	-2	-6	-21	
4390	-28	-48	-48	-62	-66	-66	-88	-84	-83	-80	-21	-21	-13	-10	-21	-2	-8	-21	
4400	-61	-43	-29	-15	-6	-5	0	3	-6	-2	49	40	40	40	40	8	15	18	
4410	10	18	27	39	44	47	50	53	55	57	49	49	49	49	49	8	8	8	
4420	55	48	41	38	41	52	65	79	88	90	23	18	18	18	18	16	15	18	
4430	87	89	95	97	97	84	72	50	32	18	18	17	18	23	18	16	11	-1	
4440	8	3	4	-1	-10	-21	-24	-28	-24	-25	-6	-7	-7	-4	-4	3	10	13	
4450	-30	-30	-26	-23	-18	-7	-7	9	14	7	18	18	15	13	5	-11	-14	-26	
4460	-2	-16	-21	-9	-3	0	-1	-1	-4	-1	4990	-29	-55	-61	-51	-45	-42	-43	
4470	9	18	18	14	7	-1	-10	-12	-11	-21	5000	-37	-34	-42	47	45	48	48	
4480	-21	-21	-21	-2	13	18	26	33	39	37	37	43	42	45	52	54	50	50	
4490	36	26	17	15	16	17	18	18	9	-1	5020	46	43	39	37	37	26	18	
4500	-3	-21	-26	-31	-35	-33	-36	-38	-64	-9	5030	18	18	10	-21	-21	-21	-23	
4510	-61	-70	-75	-76	-72	-64	-65	-68	-71	-74	-21	-34	-41	-36	-28	-28	-34	-44	
4520	-70	-61	-53	-48	-45	-44	-45	-46	-46	-41	5040	-56	-61	-66	-66	-30	-31	-31	
4530	-36	-25	-9	15	22	29	29	27	33	33	-21	-15	-9	-6	-11	-5	-7	-5	
4540	31	33	43	33	29	26	18	17	23	29	11	11	11	11	14	18	18	18	
4550	29	28	29	18	18	18	14	17	18	18	4	2	4	3	8	15	18	25	
4560	13	3	-10	-21	-16	-10	-6	0	-1	-10	32	29	18	14	9	-1	-8	-13	
4570	-21	-21	-29	-33	-38	-39	-61	-61	-61	-34	-16	-24	-24	-31	-28	-27	-26	-26	
4580	-21	-5	10	24	30	34	33	35	35	38	-28	-21	-21	-21	-16	0	14	18	
4590	44	47	48	43	37	29	18	13	13	8	5100	27	32	30	23	17	15	17	
4600	-1	-10	-21	-9	0	18	30	40	44	40	5130	17	15	8	-1	-24	-33	-41	
4610	32	18	10	5	0	-3	-15	-25	-29	-27	-43	-44	-41	-36	-33	-34	-38	-36	
4620	-21	-21	-21	-21	-26	-30	-41	-43	-61	-61	5150	-29	-24	-21	-21	-24	-41	-38	
4630	-70	-79	-90	-90	-83	-70	-61	-48	-37	-30	5160	-26	-26	-29	-32	-40	-38	-31	
4640	-22	-17	-16	-22	-31	-26	-22	-21	-21	-26	5170	9	6	-1	5	10	22	-14	
4650	-51	-51	-28	-29	-26	-21	-21	-12	-7	-4	5180	33	32	18	13	9	7	33	
4660	-6	-2	6	15	27	37	40	43	43	45	5190	8	7	5	9	10	12	12	
4670	44	38	37	37	30	23	18	17	18	18	28	28	29	25	18	10	2	2	
4680	18	18	18	16	10	5	8	8	7	5	5200	-1	-3	-1	3	11	18	33	
4690	0	-2	-9	-11	-10	-5	5	8	7	5	5220	18	18	18	27	33	36	29	
4700	49	50	54	51	48	43	38	42	38	43	5230	0	0	-1	-1	-2	-5	-6	
4710	38	32	18	14	10	6	5	6	12	18	5240	-6	-10	-21	-26	-45	-46	-49	
4720	27	29	30	33	35	40	46	48	45	38	5250	-51	-51	-50	-51	-50	-50	-26	
4730	33	28	17	6	-11	-29	-46	-61	-61	-61	5260	-29	-29	-31	-31	-28	-21	-9	
4740	-61	-69	-80	-89	-100	-93	-80	-73	-61	-52	5270	-1	4	14	26	37	47	54	
4750	-51	-48	-44	-35	-25	-16	-7	-7	-6	-4	5280	57	58	63	58	63	58	55	
4760	-11	-6	1	16	16	16	7	6	-16	-12	5290	51	49	47	58	57	57	53	
4770	-3	8	17	28	30	25	18	18	18	32	5300	-1	3	2	2	4	10	10	
4780	38	36	27	15	1	-8	-11	-21	-21	-21	5310	0	0	1	2	5	8	3	
4790	-21	-21	-21	-21	-8	0	3	4	-1	-6	5320	-7	-21	-9	-10	0	-7	-6	
4800	-4	-5	0	-1	3	5	4	8	15	18	5330	-13	-11	-11	-6	-8	-11	-21	
											5340	-9	-9	-9	-9	-11	-4	-7	-7

TO BE CONTINUED

TO BE CONTINUED

CONTINUED (F-95)										CONTINUED (F-95)											
NO.	(1)	(2)	(3)	(4)	(5)	(6)	(7)	(8)	(9)	(10)	NO.	(1)	(2)	(3)	(4)	(5)	(6)	(7)	(8)	(9)	(10)
5350	0	-7	-6	-1	2	6	9	15	18	18	5890	9	-3	-6	-10	-21	-12	-16	-21	-16	-21
5360	18	18	18	18	18	24	24	18	23	18	5900	-21	-21	-21	-21	-17	-15	-12	-21	-11	-21
5370	17	13	6	-1	-2	-3	-16	-21	-22	-24	5910	-21	-17	-21	-22	-28	-27	-12	-11	-11	-14
5380	-29	-28	-27	-27	-29	-31	-31	-27	-35	-32	5920	-25	-26	-21	-22	-28	-32	-32	-33	-31	-31
5390	-21	-21	-21	-21	-22	-31	-36	-31	-35	-21	5930	-3	-3	-4	-21	-10	-6	-6	-4	-4	-6
5400	-25	-27	-34	-37	-39	-36	-27	-35	-27	-27	5940	-1	2	-1	-1	-3	-4	-1	-1	-1	-1
5410	-26	-22	-21	-21	-4	-1	5	8	8	7	5950	-1	0	-1	-1	-1	-1	-1	-2	-2	-1
5420	9	6	4	3	0	-1	-1	2	0	0	5960	9	12	8	13	14	16	14	9	9	9
5430	5	12	16	18	18	28	32	34	39	33	5970	9	12	17	18	18	18	18	18	18	18
5440	29	18	17	13	11	9	9	7	7	12	5980	28	29	28	27	25	18	13	9	5	3
5450	9	8	5	8	9	12	17	17	18	15	5990	-1	-6	-10	-11	-13	-21	-6	-6	-5	3
5460	10	9	-1	-1	-6	-4	-6	-12	-12	-7											
5470	-6	0	5	9	13	14	15	13	16	14											
5480	13	13	12	16	16	17	18	18	15	13											
5490	15	10	12	13	12	16	17	17	18	18											
5500	18	28	18	18	10	5	0	4	0	6											
5510	9	15	18	17	15	13	8	10	9	11											
5520	14	7	9	12	18	24	28	27	17	16											
5530	10	15	17	20	24	29	31	29	28	26											
5540	18	17	13	9	0	0	-6	-7	-10	-17											
5550	-26	-29	-38	-36	-39	-41	-42	-46	-40	-40											
5560	-36	-30	-31	-27	-25	-21	-12	-6	-1	9											
5570	10	12	12	12	14	13	10	-1	-2	-8											
5580	-13	-11	-9	-5	-2	-1	3	0	0	-1											
5590	1	-2	-1	0	-1	-5	-1	-6	-6	-2											
5600	-3	-7	-11	-7	-10	-21	-21	-21	-26	-28											
5610	-30	-34	-37	-39	-35	-35	-35	-39	-41	-42											
5620	-36	-32	-25	-21	-14	-13	-9	-9	-7	-5											
5630	-1	-1	-1	-1	-1	-1	5	9	10	14											
5640	17	15	25	29	32	35	37	41	38	37											
5650	32	32	28	27	27	26	18	24	18	18											
5660	14	8	0	-8	-11	-21	-21	-24	-24	-26											
5670	-6	-28	-32	-34	-34	-31	-25	-22	-21	-8											
5680	5	14	17	17	16	15	17	17	17	14											
5690	8	-1	-6	-16	-21	-15	-21	-21	-21	-21											
5700	-1	-8	-2	6	-1	8	5	5	4	4											
5710	2	-2	-6	-11	-10	-4	-2	-4	3	6											
5720	8	5	8	8	5	9	7	3	5	8											
5730	9	14	14	14	10	10	10	14	10	10											
5740	9	9	-1	-3	-11	-21	-21	-21	-21	-23											
5750	-25	-25	-25	-24	-26	-26	-25	-28	-25	-23											
5760	-21	-12	-10	-10	-9	-9	-8	-10	-8	-8											
5770	5	-1	-3	-2	-1	0	4	8	13	18											
5780	18	18	18	14	13	12	15	18	18	18											
5790	18	13	12	14	14	15	14	8	11	9											
5800	9	13	10	12	12	14	13	14	10	9											
5810	8	4	-1	-6	-18	-25	-40	-21	-33	-38											
5820	-21	-31	-25	-28	-29	-21	-17	-26	-22	-4											
5830	2	-2	-3	-4	-7	-6	-1	-1	-1	-4											
5840	-7	-6	-6	-6	0	5	0	1	0	-1											
5850	3	7	10	13	12	14	14	14	18	18											
5860	23	28	30	29	18	18	13	10	12	12											
5870	10	10	10	9	8	9	12	14	18	18											
5880	23	18	23	18	18	18	15	17	18	13											

TO BE CONTINUED

END

RECORD = F-98 COMPONENT = N16W STATION = KAWASAKI-F
 DATE AND TIME = 1987-12-17-11-08 TOTAL NUMBER OF DATA = 6000
 SAMPLING INTERVAL = 0.010 (SEC) SCAL = 0.10000
 SIGNAL = GR. ACC.

CONTINUED (F-98 N16W)

NO.	(1)	(2)	(3)	(4)	(5)	(6)	(7)	(8)	(9)	(10)
0	-4	3	-4	0	0	-4	0	-2	2	-4
10	-4	0	-4	-1	-4	-4	0	-1	-4	-4
20	0	-4	-4	-4	-4	-4	0	-4	-4	-4
30	-4	2	-5	2	0	0	0	-4	0	-4
40	0	-4	-4	-4	-4	-4	0	-4	-4	-4
50	-4	-2	-5	0	-4	-4	0	-4	-4	-4
60	0	0	0	-4	-4	-4	0	-4	-4	-4
70	-4	0	-4	-4	-4	-4	0	-4	-4	-4
80	-4	-2	-1	0	-1	-4	0	-4	-4	-4
90	-4	0	-4	-4	0	-4	0	-4	-4	-4
100	-4	1	-4	0	-4	-4	0	-4	-4	-4
110	-4	0	-4	-4	-4	-4	0	-4	-4	-4
120	0	0	-4	-2	0	0	0	-4	-4	-4
130	-1	0	-2	0	-4	-4	0	-4	-4	-4
140	-4	0	0	0	-4	-4	0	-4	-4	-4
150	-4	-4	-4	-4	-4	-4	0	-4	-4	-4
160	-4	0	-4	0	-4	-5	-1	-4	-4	-4
170	0	-4	0	1	-4	-4	0	-4	-4	-4
180	0	-4	0	0	-4	-4	-4	-4	-4	-4
190	-4	0	-4	-4	-4	-4	-4	-4	-4	-4
200	-4	-4	-4	-2	0	0	0	-4	-4	-4
210	1	0	0	-4	0	-4	0	-4	-4	-4
220	-4	0	-4	-4	-4	-4	0	-4	-4	-4
230	-4	-4	-4	0	-4	2	-1	-4	-4	-4
240	0	-2	-4	0	-4	0	2	-4	-4	-4
250	0	-4	-1	0	-4	-4	0	-4	-4	-4
260	0	-4	-4	1	0	0	2	-4	-4	-4
270	-4	2	0	0	-4	-4	0	-4	-4	-4
280	-4	0	-4	-4	0	-4	0	-4	-4	-4
290	-4	1	-4	0	0	-4	0	-4	-4	-4
300	-4	0	-5	-2	0	-1	-4	-4	-4	-4
310	0	1	-2	-4	-4	-5	0	-4	-4	-4
320	-4	-4	0	0	-4	-5	-4	-4	-4	-4
330	0	-1	-4	0	2	-5	0	-4	-4	-4
340	-4	0	0	-2	-4	-4	0	-2	-4	-4
350	0	0	-5	-4	-4	-4	0	-4	-4	-4
360	-4	0	0	-4	-4	-4	0	-4	-4	-4
370	0	-4	-4	-4	0	0	0	-4	-4	-4
380	-4	-4	-4	2	0	-4	1	0	-4	-4
390	0	0	-5	0	0	-4	2	-1	-4	-4
400	0	0	-4	-4	-4	-4	-4	-4	-4	-4
410	0	1	-4	-4	-4	-4	-5	0	-4	-4
420	0	-2	0	-4	0	0	0	-4	-4	-4
430	-4	-4	-4	-4	0	0	0	-4	-4	-4
440	-4	-4	-4	-4	-4	-4	0	-4	-4	-4
450	-4	-4	-4	-4	-4	-4	0	-4	-4	-4
460	-4	-4	-4	-4	0	2	0	-4	-4	-4
470	0	0	-4	-4	0	-4	-5	0	-4	-4
480	-4	-4	-4	-4	-1	0	-2	-4	-4	-4

TO BE CONTINUED

TO BE CONTINUED

CONTINUED (F-98

N16W)

CONTINUED (F-98

N16W)

CONTINUED (F-98

N16W)

NO.	(1)	(2)	(3)	(4)	(5)	(6)	(7)	(8)	(9)	(10)
1030	17	15	-4	-3	-4	-10	-7	-12	-19	-25
1040	-27	-25	-19	-16	-8	2	2	-9	-23	-33
1050	-24	-9	-2	-8	-17	-24	-27	-29	-16	-16
1060	-4	-4	2	15	7	2	15	25	35	41
1070	26	17	17	15	12	17	22	12	-4	-14
1080	-14	-9	-8	-17	-4	-4	-4	-2	12	17
1090	31	24	5	4	4	-4	-7	2	0	0
1100	-8	17	-6	6	10	7	9	12	5	-2
1110	2	15	19	17	11	10	7	7	15	2
1120	10	10	9	10	17	15	7	-4	-2	-14
1130	-26	-24	-19	10	22	30	20	18	21	22
1140	15	10	-4	-4	-4	-7	-7	-12	-32	-33
1150	-57	-57	-64	-78	-72	-57	-4	12	31	31
1160	55	72	80	65	51	40	26	10	-11	-24
1170	-34	-47	-45	-26	2	33	71	110	137	142
1180	117	74	22	-23	-64	-98	-112	-106	-64	-38
1190	-39	-24	-9	-4	-14	-32	-17	-76	-52	-32
1200	-22	17	44	41	26	22	19	17	22	16
1210	1	-9	-17	-27	-26	-14	-4	22	45	50
1220	15	-32	-76	-88	-88	-77	-51	-17	7	22
1230	30	36	32	17	-4	-7	-12	1770	4	15
1240	-4	13	22	37	53	72	95	113	116	98
1250	62	20	-16	-50	-67	-69	-63	-64	-73	-85
1260	47	61	60	34	-4	-35	-50	-18	10	26
1270	86	87	88	-102	-103	-88	-57	-18	20	26
1280	34	45	40	26	12	4	4	26	52	72
1290	90	102	102	90	70	40	-5	-39	-59	-54
1300	-36	-16	9	35	51	45	46	17	-18	-42
1310	-57	-67	-63	-38	0	31	46	50	43	25
1320	-7	-45	-69	-86	-90	-78	-62	-44	-30	-4
1330	45	81	115	127	114	86	65	30	-18	-47
1340	-39	4	15	22	15	17	26	17	-15	-39
1350	-54	-59	-44	-17	10	41	72	95	106	102
1360	71	19	-22	-39	-45	-48	-51	-48	-24	-15
1370	-4	15	20	15	-4	-12	-29	-49	-59	-62
1380	-52	-42	-38	-22	-37	-59	-77	-98	-133	-153
1390	-152	-142	-136	-115	-76	-34	0	36	70	110
1400	135	140	127	120	113	99	86	72	64	51
1410	36	24	15	-4	-4	-9	-4	15	30	30
1420	41	47	41	26	5	-15	-34	-47	-42	-26
1430	-9	-2	-4	1	-4	-4	-4	-32	-49	-54
1440	-47	-42	-36	-27	-9	10	30	65	67	67
1450	71	90	100	97	95	89	80	60	36	10
1460	-5	7	12	-2	17	-16	-15	-32	-57	-85
1470	-97	-98	-98	-88	-47	-4	22	50	76	80
1480	52	25	7	-7	-17	-15	22	15	17	7
1490	-17	-52	-88	-112	-125	-133	-156	-138	-142	-123
1500	-91	-59	-16	42	85	102	109	101	84	71
1510	52	22	-4	-14	-23	-14	7	37	61	75
1520	30	71	70	53	12	-24	-46	-49	-36	-7
1530	37	96	140	156	150	114	60	-4	-38	-62
1540	-73	-68	-73	-54	-28	7	22	10	-16	-44
1550	-64	-78	-73	-49	-17	20	37	50	41	22
1560	-5	-29	-57	-67	-73	-77	-73	-62	-54	-46

TO BE CONTINUED

TO BE CONTINUED

NO.	(1)	(2)	(3)	(4)	(5)	(6)	(7)	(8)	(9)	(10)
2110	465	412	361	300	240	195	167	151	135	126
2120	125	122	107	100	111	126	141	165	195	226
2130	261	314	379	449	524	605	680	750	810	868
2140	863	858	836	793	753	709	659	629	609	600
2150	599	609	630	645	703	735	752	733	740	705
2160	654	583	509	429	351	270	195	130	78	54
2170	66	115	205	311	411	501	569	601	580	504
2180	386	245	95	-63	-188	-284	-348	-381	-358	-284
2190	313	248	182	-111	-39	5	10	-19	-88	-197
2200	318	436	533	598	647	676	676	636	554	438
2210	303	183	116	84	-69	-64	-77	-88	-98	-102
2220	108	146	203	292	369	416	443	448	436	403
2230	348	291	218	162	127	102	74	57	-59	-85
2240	128	193	257	328	408	463	497	521	517	476
2250	393	286	163	-54	35	99	142	160	149	111
2260	55	-9	-82	-152	-213	-258	-278	-286	-292	-288
2270	278	271	268	275	278	279	264	238	201	164
2280	118	75	127	5	40	72	85	90	74	74
2290	115	122	136	161	201	260	306	354	402	434
2300	448	440	429	399	341	284	240	184	142	121
2310	120	134	166	216	280	348	420	474	519	539
2320	540	531	498	439	351	243	134	44	-37	-101
2330	138	138	108	-49	15	95	170	220	251	275
2340	286	282	271	251	220	176	130	70	15	-39
2350	-77	-110	-127	-117	-69	12	117	225	311	358
2360	309	265	108	-59	-214	-378	-521	-607	-652	-656
2370	643	521	435	344	258	203	166	138	128	137
2380	165	193	217	227	228	212	187	147	153	172
2390	172	204	238	273	298	313	308	278	228	172
2400	-112	-49	15	72	134	200	261	316	359	383
2410	387	373	356	336	315	286	250	217	186	164
2420	155	170	185	205	223	236	247	255	262	285
2430	314	357	399	444	484	504	477	404	301	195
2440	73	-52	-158	-243	-297	-323	-328	-308	-288	-244
2450	-278	-275	-281	-280	-278	-274	-263	-237	-197	-142
2460	-86	-39	-15	0	12	11	0	-34	-85	-132
2470	162	186	226	273	323	368	423	461	461	428
2480	-382	-351	-277	-217	-162	-117	-73	-34	2	44
2490	95	151	211	266	310	348	376	381	356	313
2500	267	220	166	127	100	95	110	105	161	166
2510	161	154	150	152	171	204	255	306	369	426
2520	472	501	524	529	503	451	381	314	257	213
2530	170	141	130	96	70	40	7	-32	-278	-330
2540	-197	-256	-298	-326	-328	-314	-273	-203	-118	-29
2550	47	123	182	221	232	216	190	150	115	95
2560	80	73	70	56	34	-2	-37	-78	-127	-162
2570	188	198	207	213	228	244	251	248	238	238
2580	-242	-246	-248	-244	-217	-172	-128	-97	-78	-64
2590	-56	-52	-58	-78	-108	-152	-193	-233	-257	-264
2600	-246	-208	-162	-123	-92	-64	-49	-28	-5	21
2610	45	65	79	90	87	80	69	55	50	50
2620	46	40	26	5	-24	-64	-108	-142	-162	-161
2630	-142	-112	-84	-53	-22	10	32	51	64	76
2640	82	82	81	75	74	74	70	62	56	37

TO BE CONTINUED

TO BE CONTINUED

CONTINUED(F-98 NT6W)										
NO.	(1)	(2)	(3)	(4)	(5)	(6)	(7)	(8)	(9)	(10)
3190	-309	-213	-208	-196	-174	-143	-112	-78	-52	-19
3200	12	41	65	86	95	87	86	87	87	90
3210	90	97	105	110	106	90	70	41	16	-5
3220	-22	-49	-77	-88	-84	-62	-27	12	58	95
3230	130	157	165	154	131	101	71	40	5	-18
3240	-34	-36	-34	-27	-19	-14	-12	-9	-7	-12
3250	-14	-17	-24	-27	-37	-50	-61	-69	-72	-77
3260	-86	-98	-112	-107	-87	-51	-14	14	34	40
3270	30	15	-14	-38	-50	-47	-34	-13	11	36
3280	61	85	101	113	115	105	90	72	62	60
3290	55	52	60	71	76	105	116	130	135	136
3300	124	102	121	131	130	-76	-103	-138	-166	-166
3310	-196	-217	-218	-203	-203	-192	-174	-156	-125	-125
3320	-108	-98	-86	-62	-29	-4	39	75	109	132
3330	145	155	160	175	189	205	220	231	240	250
3340	260	267	277	290	304	316	334	342	345	344
3350	334	321	300	266	230	180	140	94	55	26
3360	-4	-16	-39	-64	-98	-135	-168	-202	-237	-267
3370	-300	-333	-362	-377	-383	-382	-371	-358	-343	-329
3380	-313	-297	-278	-263	-255	-247	-244	-242	-237	-217
3390	-189	-153	-108	-67	-29	-4	10	21	30	35
3400	41	47	55	70	80	91	96	100	105	110
3410	115	116	110	110	110	114	113	130	131	120
3420	112	107	101	95	82	61	36	15	-13	-35
3430	-52	-69	-87	-102	-108	-124	-132	-132	-128	-123
3440	-113	-98	-87	-72	-56	-19	-4	11	37	44
3450	14	16	18	20	24	35	46	61	77	95
3460	111	130	144	150	154	144	141	141	141	141
3470	150	156	171	196	221	245	261	275	280	280
3480	272	261	236	205	164	116	61	15	-35	-64
3490	-86	-96	-92	-78	-64	-52	-39	-34	-37	-42
3500	-59	-88	-117	-154	-184	-212	-233	-246	-248	-246
3510	-237	-218	-198	-177	-158	-148	-143	-147	-148	-148
3520	-157	-158	-162	-158	-148	-138	-124	-103	-83	-67
3530	-42	-12	26	61	95	127	154	175	186	186
3540	179	162	144	127	111	95	83	72	65	62
3550	61	60	51	35	15	-16	-33	-88	-135	-145
3560	-157	-158	-143	-122	-97	-78	-71	-66	-67	-77
3570	-88	-105	-118	-137	-153	-163	-167	-167	-162	-142
3580	-117	-82	-49	-21	-4	14	23	20	10	-4
3590	-5	-2	7	30	55	80	105	130	155	180
3600	197	212	226	232	238	233	221	201	181	159
3610	137	116	100	90	80	66	55	42	31	22
3620	15	10	12	12	14	11	7	2	-6	-10
3630	-12	-7	-6	-4	-4	6	10	10	4	-4
3640	-4	-7	-7	-4	-5	-12	-22	-36	-33	-42
3650	-84	-84	-72	-49	-19	14	40	61	71	76
3660	76	67	57	37	24	17	12	12	17	22
3670	31	35	37	34	26	17	-4	-14	-25	-36
3680	-39	-39	-30	-9	10	19	26	36	63	51
3690	51	50	46	50	51	59	65	65	60	50
3700	41	26	9	-8	-24	-43	-62	-76	-87	-92
3710	-93	-88	-84	-71	-60	-57	-54	-54	-54	-54
3720	-56	-59	-62	-59	-64	-67	-73	-86	-96	-103

TO BE CONTINUED

TO BE CONTINUED

CONTINUED (F-98 M16W)

NO.	(1)	(2)	(3)	(4)	(5)	(6)	(7)	(8)	(9)	(10)
4270	50	39	35	31	27	24	20	20	23	27
4280	36	51	65	80	96	107	117	116	111	100
4290	85	66	51	34	37	34	44	59	75	92
4300	106	120	130	137	150	156	161	164	171	176
4310	182	182	180	166	151	127	96	60	20	-17
4320	-54	-84	-104	-122	-128	-142	-143	-143	-142	-139
4330	-138	-143	-148	-163	-175	-188	-204	-214	-223	-232
4340	-232	-233	-228	-221	-207	-197	-187	-177	-168	-167
4350	-169	-173	-183	-197	-208	-217	-222	-222	-212	-197
4360	-178	-155	-128	-101	-72	-46	-21	-4	20	34
4370	50	60	64	71	72	81	91	101	115	125
4380	131	140	150	150	150	144	140	133	129	121
4390	120	117	121	125	126	131	132	135	140	145
4400	155	170	180	192	206	214	220	220	215	201
4410	186	175	159	150	140	135	129	135	126	120
4420	112	101	86	70	50	34	20	10	-4	-6
4430	-6	-4	-4	10	20	31	43	50	51	51
4440	50	41	35	26	18	10	-5	-18	-37	-56
4450	-78	-98	-118	-138	-153	-166	-174	-173	-168	-168
4460	-167	-168	-172	-174	-178	-178	-182	-177	-172	-168
4470	-165	-159	-153	-147	-143	-141	-136	-132	-127	-120
4480	-112	-102	-93	-86	-77	-68	-62	-55	-52	-47
4490	-47	-49	-55	-59	-62	-66	-67	-63	-62	-58
4500	-56	-54	-49	-49	-47	-45	-37	-30	-22	-15
4510	-6	-4	7	11	15	17	25	34	40	45
4520	50	51	51	46	41	39	36	36	37	41
4530	46	50	52	52	60	65	71	71	71	66
4540	60	47	41	31	30	31	42	60	77	97
4550	115	123	130	125	115	106	95	80	66	56
4560	47	42	41	41	42	44	46	51	55	51
4570	51	54	51	47	44	40	34	24	19	15
4580	7	0	-7	-17	-29	-44	-50	-57	-57	-52
4590	-47	-42	-39	-35	-34	-39	-43	-49	-54	-64
4600	-72	-83	-92	-97	-103	-107	-103	-103	-97	-87
4610	-77	-67	-58	-49	-47	-47	-47	-53	-59	-66
4620	-72	-77	-77	-72	-64	-69	-75	-82	-92	-99
4630	-17	-28	-47	-64	-84	-98	-107	-108	-103	-97
4640	-87	-75	-59	-49	-43	-41	-39	-37	-34	-34
4650	-29	-24	-24	-19	-14	-8	-4	2	13	22
4660	35	49	62	72	86	90	90	85	77	67
4670	56	42	35	33	30	33	35	36	40	39
4680	34	30	22	15	5	-4	-6	-4	0	5
4690	10	15	15	15	15	-4	-6	-17	-27	-35
4700	-44	-49	-52	-55	-54	-57	-57	-49	-42	-34
4710	-25	-9	2	11	17	23	30	31	31	29
4720	26	26	22	20	12	-4	-9	-9	-13	-19
4730	-17	-17	-22	-27	-29	-39	-49	-57	-67	-69
4740	-73	-73	-64	-57	-42	-24	-6	16	40	55
4750	75	90	104	114	120	121	120	114	102	91
4760	82	71	66	60	60	56	55	51	50	45
4770	50	54	57	65	64	62	55	40	20	0
4780	-21	59	-55	-69	-74	-77	-72	-64	-59	-49
4790	-42	-37	-35	-36	-39	-47	-53	-62	-69	-72
4800	-73	-77	-81	-78	-64	-64	-52	-39	-25	-9

TO BE CONTINUED

CONTINUED (F-98 M16W)

NO.	(1)	(2)	(3)	(4)	(5)	(6)	(7)	(8)	(9)	(10)
4810	-4	15	19	22	22	20	15	7	-4	-4
4820	-6	-7	-7	-13	-14	-19	-25	-32	-39	-44
4830	-46	-44	-42	-32	-22	-9	-4	-4	-4	-4
4840	-4	-4	2	7	15	22	31	39	46	50
4850	52	56	60	60	65	66	68	70	67	65
4860	60	55	45	33	26	22	23	30	40	52
4870	66	74	82	86	89	85	75	66	55	46
4880	40	34	40	44	51	60	70	75	75	76
4890	72	66	60	53	55	60	62	75	90	102
4900	123	142	156	170	179	186	189	190	191	192
4910	194	194	191	192	186	180	171	161	151	140
4920	127	112	97	80	60	42	25	4	-12	-24
4930	-37	-49	-69	-83	-101	-113	-126	-136	-142	-147
4940	-145	-138	-128	-118	-108	-98	-87	-88	-92	-97
4950	-102	-107	-110	-108	-107	-103	-97	-91	-86	-78
4960	-75	-64	-67	-64	-67	-67	-69	-72	-69	-64
4970	-61	-49	-34	-23	-14	-7	-4	-4	-4	-5
4980	-9	-22	-37	-49	-67	-82	-92	-106	-112	-118
4990	-123	-138	-133	-138	-142	-143	-143	-138	-132	-118
5000	-103	-88	-72	-54	-42	-28	-19	-9	-4	12
5010	27	40	55	67	81	95	100	105	105	101
5020	96	95	81	70	60	51	50	46	50	60
5030	71	81	95	104	115	130	133	140	140	136
5040	130	120	110	95	90	81	75	76	75	71
5050	70	64	60	50	40	30	22	20	15	15
5060	15	17	16	17	14	7	2	-6	-16	-26
5070	-35	-39	-47	-55	-59	-64	-67	-72	-77	-84
5080	-84	-86	-87	-88	-88	-88	-82	-89	-87	-84
5090	-86	-78	-82	-78	-85	-87	-84	-84	-87	-87
5100	-78	-67	-57	-49	-37	-27	-24	-24	-32	-32
5110	-39	-42	-43	-39	-34	-24	-12	-4	15	20
5120	30	36	42	47	51	52	60	67	77	90
5130	95	101	104	107	109	110	110	105	101	103
5140	105	105	105	111	111	110	102	97	91	82
5150	80	71	65	56	46	36	22	10	7	-22
5160	-38	-49	-59	-64	-72	-78	-78	-86	-88	-95
5170	-102	-107	-108	-112	-112	-112	-112	-112	-108	-112
5180	-117	-117	-118	-117	-115	-114	-107	-97	-88	-78
5190	-72	-64	-57	-49	-44	-39	-32	-27	-19	-13
5200	-4	1	15	15	16	15	6	0	-7	-17
5210	-23	-31	-32	-37	-38	-39	-38	-35	-29	-24
5220	-17	-9	-5	-4	10	15	17	25	25	25
5230	26	27	30	32	40	41	41	42	41	40
5240	37	36	35	36	37	36	36	32	31	31
5250	31	31	34	37	47	60	70	77	85	95
5260	95	95	95	79	71	57	46	34	30	17
5270	12	5	-4	-4	-4	-4	-4	-4	2	6
5280	6	5	-4	-4	-7	-17	-24	-32	-39	-67
5290	-57	-62	-67	-73	-77	-82	-86	-86	-86	-85
5300	-88	-91	-92	-93	-103	-108	-113	-121	-127	-128
5310	-128	-125	-123	-122	-118	-117	-117	-117	-117	-113
5320	-108	-107	-97	-87	-78	-70	-62	-55	-52	-47
5330	-44	-42	-34	-28	-17	-4	10	25	40	47
5340	56	61	65	71	74	79	81	84	86	95

TO BE CONTINUED

CONTINUED (F-98)

RT16W)

CONTINUED (F-98)

N16W)

NO.	(1)	(2)	(3)	(4)	(5)	(6)	(7)	(8)	(9)	(10)
5350	96	102	112	121	131	140	146	146	146	142
5360	137	130	120	110	100	97	91	95	95	95
5370	95	100	102	103	101	96	92	90	82	79
5380	76	74	72	75	75	74	72	71	67	64
5390	64	57	45	32	19	4	-12	-28	-47	-59
5400	-72	-82	-85	-87	-88	-87	-86	-88	-98	-108
5410	-122	-133	-143	-153	-158	-162	-158	-153	-143	-138
5420	-137	-132	-128	-127	-133	-133	-137	-142	-143	-133
5430	-143	-142	-137	-128	-117	-108	-97	-84	-70	-57
5440	-45	-38	-29	-24	-20	-17	-15	-13	-9	-9
5450	-7	-5	2	3	7	10	15	10	15	11
5460	10	12	12	12	16	15	17	22	30	34
5470	45	54	66	76	86	95	99	104	110	113
5480	112	115	115	114	115	120	117	120	120	113
5490	103	94	79	64	52	40	32	22	17	15
5500	5	-2	-7	-17	-22	-29	-37	-44	-49	-49
5510	-56	-59	-64	-64	-72	-69	-66	-62	-59	-57
5520	-49	-49	-45	-41	-40	-37	-38	-40	-37	-37
5530	-37	-34	-32	-29	-25	-19	-13	-6	-4	4
5540	12	19	20	25	27	30	30	29	30	30
5550	25	25	22	22	20	20	20	19	20	20
5560	17	17	15	12	7	10	12	15	18	22
5570	26	30	31	31	29	26	25	22	17	12
5580	-4	-4	-7	-9	-9	-7	-4	4	15	25
5590	31	36	40	42	46	46	51	55	58	62
5600	70	80	84	93	100	102	105	110	106	101
5610	100	94	95	87	95	81	80	76	72	66
5620	60	51	40	30	20	15	4	-1	-9	-17
5630	-23	-27	-28	-26	-29	-28	-29	-32	-38	-47
5640	-54	-69	-81	-97	-112	-127	-141	-148	-158	-163
5650	-166	-164	-158	-157	-153	-143	-137	-131	-122	-113
5660	-108	-102	-95	-83	-79	-73	-64	-62	-54	-49
5670	-46	-39	-37	-29	-27	-18	-14	-6	0	5
5680	7	10	11	9	10	10	15	20	30	35
5690	41	45	53	57	60	62	68	70	75	81
5700	85	85	95	95	90	95	95	95	93	95
5710	100	105	114	122	131	141	151	159	165	170
5720	167	166	164	155	150	141	136	127	122	119
5730	117	116	120	120	126	130	131	131	130	122
5740	114	104	95	87	79	72	69	62	60	55
5750	67	62	37	30	21	15	2	-9	-24	-39
5760	-57	-72	-86	-107	-118	-131	-138	-148	-153	-158
5770	-158	-162	-166	-166	-166	-168	-172	-177	-178	-179
5780	-183	-183	-182	-181	-176	-172	-164	-152	-141	-128
5790	-118	-108	-97	-88	-82	-75	-64	-62	-57	-49
5800	-47	-44	-37	-37	-33	-28	-22	-11	-2	12
5810	22	32	46	55	62	70	74	75	77	80
5820	78	77	75	74	72	75	74	75	72	70
5830	67	65	62	64	65	65	67	70	65	60
5840	52	46	40	29	21	15	10	2	-2	-6
5850	-4	-4	-7	-4	0	5	10	17	25	31
5860	36	42	46	51	55	60	64	70	72	75
5870	79	75	80	80	79	76	72	70	64	56
5880	50	39	30	21	15	7	-4	-5	-12	-20

TO BE CONTINUED

END

RECORD = F-98 COMPONENT = E16N STATION = KAWASAKI-F
 DATE AND TIME = 1987-12-17-11-08 TOTAL NUMBER OF DATA = 6000
 SAMPLING INTERVAL = 0.010 (SEC) SCAL = 0.10000
 SIGNAL = GR. ACC.

CONTINUED(F-98 E16N)

NO.	(1)	(2)	(3)	(4)	(5)	(6)	(7)	(8)	(9)	(10)
0	-2	-2	0	-1	0	-2	0	-2	0	-2
10	-2	-2	0	0	-1	0	0	1	-2	-2
20	-2	-2	0	0	0	-2	0	0	-2	-2
30	0	0	-2	0	0	0	0	-2	0	0
40	0	0	-2	-2	-2	-2	0	0	-2	-2
50	-2	-2	0	-2	-2	0	-2	-2	0	0
60	0	-2	0	-2	-2	-2	-2	-2	0	0
70	0	-2	0	0	-2	-2	-2	-2	0	0
80	0	-2	-2	0	0	0	0	0	0	0
90	-2	0	0	0	-1	-2	0	0	0	0
100	-1	0	0	0	0	-2	0	0	0	0
110	0	-2	0	2	-2	-2	0	0	0	0
120	-2	0	-2	0	0	-2	-2	-2	-2	-2
130	0	-2	0	0	-1	0	0	-2	0	0
140	0	0	-2	0	0	-2	-2	-2	0	0
150	0	-2	1	0	0	-2	-2	-2	0	0
160	-2	0	0	0	0	-2	0	0	0	0
170	0	-2	0	0	0	2	0	1	-2	-2
180	2	0	-2	0	0	-2	-2	-2	-2	-2
190	-2	0	0	-2	-2	-1	0	1	0	0
200	-2	0	0	0	0	0	0	-2	0	0
210	-2	0	-2	0	-1	0	-2	0	0	0
220	-2	0	0	0	0	-2	0	0	0	0
230	0	0	0	0	0	-2	0	0	0	0
240	2	-2	1	0	0	-2	0	0	0	0
250	-2	0	0	-2	-2	-2	0	-2	0	0
260	-2	0	0	-2	-2	-2	-2	-2	0	0
270	1	-2	0	-2	-2	-2	0	0	0	0
280	0	0	0	0	0	-2	0	0	0	0
290	-2	0	0	-2	-2	-2	0	0	0	0
300	0	-2	-2	-2	-2	-2	0	0	0	0
310	2	-2	0	0	0	-2	0	0	0	0
320	-2	3	0	0	0	-2	0	0	0	0
330	-2	0	0	0	-2	-2	0	0	0	0
340	-2	0	0	0	0	-2	0	0	0	0
350	0	0	0	0	-2	-2	-2	-2	-2	-2
360	-2	-2	1	2	2	-2	-2	-2	-2	-2
370	-2	1	0	-2	0	-2	0	0	0	0
380	-2	1	0	-2	-1	-2	0	0	0	0
390	-1	-2	0	-2	-1	-2	-2	-2	-2	-2
400	0	0	0	0	0	-2	-2	-2	-2	-2
410	0	-2	0	-2	-1	-2	0	0	0	0
420	0	-2	0	-2	-2	-2	0	0	0	0
430	-2	0	-2	-2	-2	-2	0	0	0	0
440	-2	0	-1	-2	0	-2	0	0	0	0
450	0	-2	-2	-2	0	-2	0	0	0	0
460	-2	-2	-2	-2	0	-2	0	0	0	0
470	-2	-2	-2	-2	0	-2	0	0	0	0
480	1	-2	-2	0	-2	-2	0	0	0	0

TO BE CONTINUED

TO BE CONTINUED

CONTINUED(F-98

E16N)

CONTINUED(F-98

E16N)

NO.	(1)	(2)	(3)	(4)	(5)	(6)	(7)	(8)	(9)	(10)
1030	-20	-15	-6	-1	4	9	6	-2	9	5
1040	9	17	24	27	24	17	9	9	12	12
1050	7	17	24	32	32	24	19	14	9	4
1060	17	12	17	12	-2	-19	-30	-31	-24	-16
1070	-16	-21	-21	-24	-17	-15	-6	-1	-10	-9
1080	0	3	-2	-2	-2	-1	-2	7	19	29
1090	42	44	37	32	33	33	29	20	7	6
1100	-24	-21	-21	-25	-23	-24	-24	-15	-3	7
1110	8	-4	-10	-15	-15	-11	-10	-11	-15	-15
1120	-16	-18	-25	-35	-40	-32	-16	-4	-2	2
1130	-1	-6	-11	-5	12	26	29	26	32	42
1140	53	62	57	37	19	-2	-11	-16	-12	-11
1150	-15	-9	-2	-4	-11	-31	-30	-56	-56	-56
1160	-60	-60	-51	-41	-21	-2	18	27	22	18
1170	17	7	-6	-21	-34	-25	-2	41	71	83
1180	92	94	93	76	42	-2	-25	-33	-25	-8
1190	14	49	102	151	176	163	128	76	17	55
1200	-116	-155	-165	-153	-120	-11	53	106	127	17
1210	111	53	-6	-77	-126	-148	-154	-140	-100	-39
1220	17	62	92	97	92	76	56	24	-2	25
1230	-56	-94	-116	-133	-123	-94	-36	-33	-21	-25
1240	-36	-36	-26	-14	3	33	66	97	113	112
1250	83	42	-9	-55	-66	-30	-16	22	63	87
1260	82	61	43	33	17	-6	-34	-45	-42	-35
1270	-30	-23	-15	-10	-2	19	36	58	69	67
1280	48	29	6	12	2	-2	-1	-2	9	25
1290	39	39	26	17	9	25	53	75	68	43
1300	-1	-55	-84	-73	-40	9	72	120	135	132
1310	113	92	60	21	-5	-5	19	51	59	42
1320	19	9	17	7	-14	-42	-66	-80	-91	-95
1330	-96	-101	-106	-110	-104	-90	-95	-61	-55	-61
1340	-40	-15	7	18	17	0	-5	-3	10	37
1350	74	121	155	167	148	97	23	-61	-95	-138
1360	-161	-144	-116	-98	-85	-61	-41	-25	-9	-2
1370	9	4	-1	-10	-14	-9	18	62	98	122
1380	132	118	87	57	24	-6	-44	-71	-91	-100
1390	-101	-73	-36	-5	23	43	52	42	14	-9
1400	-15	-6	9	33	58	67	58	43	33	42
1410	56	62	47	22	-6	-35	-51	-53	-76	-16
1420	-3	4	9	-6	-51	-96	-107	-86	-46	-11
1430	17	52	92	112	123	137	154	156	123	74
1440	27	-11	-57	-100	-137	-152	-140	-116	-86	-66
1450	-56	-55	-46	-40	-36	-40	-37	-16	23	68
1460	98	113	123	113	82	47	19	-5	-30	-44
1470	-43	-27	-9	17	42	62	62	51	38	32
1480	47	19	0	-22	-35	-24	17	67	116	154
1490	171	158	133	103	63	13	-30	-66	-85	-82
1500	-56	-26	0	17	27	24	12	-14	-54	-96
1510	-137	-173	-195	-204	-210	-209	-194	-155	-109	-61
1520	-25	-10	-1	-1	-10	-24	-30	-25	-10	4
1530	17	24	38	54	65	69	78	94	102	93
1540	68	36	-2	-23	-31	-26	-35	-40	-50	-50
1550	-71	-101	-140	-181	-201	-181	-154	-122	-85	-85
1560	-42	6	52	86	103	106	102	82	66	47

TO BE CONTINUED

TO BE CONTINUED

NO.	(1)	(2)	(3)	(4)	(5)	(6)	(7)	(8)	(9)	(10)
2110	284	241	176	81	-17	-86	-140	-186	-215	-220
2120	-231	-225	-208	-180	-165	-160	-165	-195	-220	-252
2130	-284	-298	-283	-250	-205	-149	-86	-35	3	38
2140	63	65	62	64	12	-31	-71	-104	-135	-168
2150	-194	-214	-240	-253	-248	-233	-203	-134	-95	-51
2160	39	113	192	282	371	460	548	632	704	757
2170	772	747	687	592	490	394	310	223	136	57
2180	-5	-46	-81	-94	-90	-56	10	64	151	243
2190	340	418	465	479	459	404	336	264	205	158
2200	123	114	123	141	166	202	242	292	342	373
2210	381	350	282	184	62	-95	-573	-451	-617	-761
2220	-851	-895	-888	-814	-675	-505	-322	-154	-35	48
2230	107	141	161	150	115	74	38	7	-15	-29
2240	-21	5	44	87	112	116	102	53	-30	-134
2250	-240	-334	-402	-458	-513	-567	-610	-637	-628	-582
2260	-489	-364	-233	-95	12	63	65	32	-16	-62
2270	-74	-61	-30	-2	-2	-42	-106	-175	-230	-201
2280	-251	-248	-225	-190	-134	-122	-66	19	72	12
2290	62	112	151	203	257	292	315	327	335	340
2300	340	327	292	249	208	153	88	19	-61	-154
2310	-224	-265	-278	-265	-224	-161	-93	-31	38	112
2320	170	222	267	294	304	299	287	267	242	222
2330	216	226	253	270	262	216	124	17	-101	-213
2340	-313	-390	-432	-433	-390	-304	-201	-96	-6	-68
2350	133	177	197	194	176	132	82	27	-25	-60
2360	-74	-69	-46	-16	-1	-6	-18	-24	-25	-24
2370	-20	-5	17	43	52	26	-35	-112	-190	-245
2380	-268	-261	-230	-183	-126	-56	3	41	57	76
2390	97	113	116	118	114	96	68	42	17	1
2400	-2	19	36	57	78	99	118	137	163	178
2410	178	165	138	113	102	92	82	72	63	-2
2420	-49	-96	-134	-159	-169	-149	-95	-12	83	177
2430	257	315	355	361	338	274	176	58	-46	-135
2440	-204	-242	-245	-215	-154	-74	9	83	162	239
2450	312	377	419	435	421	376	313	251	195	161
2460	136	106	64	-2	-60	-126	-175	-188	-134	-31
2470	76	176	242	271	256	199	133	74	29	12
2480	-1	-16	41	-79	-139	-215	-300	-372	-432	-481
2490	-517	-547	-572	-585	-587	-591	-581	-570	-542	-493
2500	-416	-314	-200	-76	36	132	187	201	183	143
2510	103	83	78	83	82	57	82	57	80	143
2520	-390	-463	-519	-531	-508	-452	-372	-273	-170	-75
2530	22	113	192	262	322	375	411	431	436	429
2540	409	381	344	305	261	221	193	186	183	186
2550	188	172	151	117	117	76	37	7	-3	12
2560	60	133	205	267	322	351	351	320	270	203
2570	123	32	-54	-117	-155	-159	-123	-81	-1	-60
2580	114	158	173	176	171	153	123	81	219	-23
2590	-76	-137	-190	-225	-238	-233	-221	-204	-158	-143
2600	185	-193	-209	-220	-243	-253	-260	-263	-258	-243
2610	-214	-167	-114	-54	7	57	97	119	145	172
2620	191	197	195	185	171	151	132	122	115	108
2630	107	101	92	76	54	24	-11	-54	-90	-119
2640	-140	-155	-154	-144	-133	-111	-86	-66	-45	-26

TO BE CONTINUED

TO BE CONTINUED

CONTINUED(F-98

E16N)

CONTINUED(F-98

E16N)

NO.	(1)	(2)	(3)	(4)	(5)	(6)	(7)	(8)	(9)	(10)
3190	-2	5	14	32	48	63	72	76	76	76
3200	82	92	93	92	83	78	67	54	47	43
3210	42	42	33	21	6	-5	-6	-7	-4	-2
3220	6	14	24	33	42	41	32	17	-2	-16
3230	-34	-41	-46	-53	-56	-55	-45	-36	-27	-16
3240	-6	2	9	19	9	17	29	37	33	32
3250	17	-5	-36	-69	-99	-124	-149	-170	-190	-203
3260	-205	-199	-183	-155	-131	-109	-85	-66	-51	-35
3270	-23	-14	-5	0	2	4	3	12	22	22
3280	47	52	48	42	32	19	8	2	9	22
3290	42	62	83	98	96	86	67	42	9	-18
3300	-40	-55	-57	-49	-31	-20	-15	-15	-15	-16
3310	-15	-11	-13	-6	-2	21	36	54	74	103
3320	135	167	201	233	262	280	279	270	235	198
3330	161	126	97	68	46	32	21	14	12	4
3340	-1	-12	-14	-8	-10	-6	-6	-10	-15	-22
3350	-33	-46	-66	-84	-98	-106	-116	-121	-124	-117
3360	-101	-75	-42	-6	24	51	69	82	83	79
3370	72	59	42	29	-2	-25	-56	-86	-109	-128
3380	-134	-132	-114	-91	-57	-18	19	53	75	89
3390	96	97	93	92	102	112	132	148	163	172
3400	172	166	155	143	133	132	133	141	147	155
3410	156	146	124	97	62	24	-5	-31	-55	-70
3420	-75	-76	-84	-86	-95	-95	-95	-94	-91	-90
3430	-90	-90	-89	-86	-85	-90	-93	-103	-117	-134
3440	-152	-165	-175	-180	-185	-189	-180	-174	-162	-145
3450	-127	-110	-96	-76	-84	-84	-85	-83	-76	-55
3460	-21	-2	39	76	102	109	103	83	59	37
3470	20	14	12	14	24	41	63	97	118	143
3480	158	155	142	112	69	29	-6	-40	-59	-72
3490	-77	-81	-74	-61	-46	-31	-11	-2	14	22
3500	27	27	22	15	9	2	-5	-15	-20	-32
3510	-44	-59	-66	-72	-75	-75	-70	-61	-57	-41
3520	-15	4	24	43	57	54	48	42	24	9
3530	-4	-15	-21	-26	-29	-22	-8	5	22	29
3540	37	42	44	42	33	16	4	-10	-26	-45
3550	-60	-66	-71	-71	-72	-66	-61	-60	-61	-61
3560	-76	-86	-96	-109	-114	-122	-129	-134	-135	-135
3570	-134	-133	-126	-121	-111	-95	-81	-61	-42	-16
3580	-2	24	38	42	36	22	-2	-26	-45	-84
3590	-105	-124	-130	-126	-113	-91	-66	-42	-25	-15
3600	-5	2	22	47	81	126	172	221	261	290
3610	310	317	311	295	262	228	192	156	136	125
3620	118	114	109	98	82	62	34	7	-24	-55
3630	-82	-104	-122	-126	-134	-133	-129	-122	-109	-82
3640	-51	-14	24	67	103	136	158	181	192	197
3650	194	181	153	113	63	12	-36	-79	-109	-129
3660	-134	-123	-103	-72	-51	-21	4	32	47	58
3670	64	72	72	73	66	58	45	36	24	14
3680	2	-15	-39	-60	-76	-99	-104	-101	-101	-97
3690	-95	-88	-100	-101	-111	-109	-101	-91	-76	-56
3700	-42	-26	-25	-26	-33	-43	-51	-61	-64	-65
3710	-60	-69	-56	-55	-60	-60	-71	-85	-90	-96
3720	-99	-96	-86	-74	-45	-13	24	57	87	109

TO BE CONTINUED

TO BE CONTINUED

NO.	(1)	(2)	(3)	(4)	(5)	(6)	(7)	(8)	(9)	(10)
4270	37	38	36	29	17	0	-16	-55	-54	-67
4280	-82	-89	-92	-91	-89	-82	-72	-61	-50	-44
4290	-35	-31	-31	-31	-33	-31	-40	-41	-51	-44
4300	-61	-71	-84	-95	-109	-119	-124	-121	-110	-95
4310	-71	-51	-21	-15	-6	-5	-10	-15	-11	-11
4320	-4	2	12	21	32	39	48	58	67	67
4330	59	47	29	12	-8	-21	-33	-35	-34	-26
4340	-16	-2	12	27	38	48	57	62	62	62
4350	62	63	69	73	81	88	102	110	122	127
4360	133	132	125	116	103	91	72	56	44	33
4370	24	14	3	-5	-11	-6	-1	7	7	7
4380	14	14	17	15	12	19	12	19	19	19
4390	24	22	12	-3	-12	-25	-36	-46	-52	-55
4400	-55	-56	-61	-65	-70	-76	-77	-69	-56	-56
4410	-45	-32	-20	-11	-5	-2	-2	-2	-2	-5
4420	-16	-29	-42	-56	-62	-66	-74	-72	-64	-68
4430	-96	-100	-101	-96	-86	-82	-75	-72	-70	-69
4440	-66	-56	-51	-42	-35	-26	-26	-25	-21	-21
4450	-16	-14	-10	-4	0	6	9	19	30	47
4460	62	76	86	91	93	97	97	102	112	123
4470	133	146	153	158	163	171	176	181	183	183
4480	177	163	151	132	107	87	67	52	38	29
4490	24	21	24	29	29	32	33	33	36	42
4500	46	52	57	62	65	72	69	67	64	59
4510	57	43	32	17	2	-15	-33	-47	-61	-84
4520	-102	-117	-130	-135	-138	-139	-135	-135	-139	-140
4530	-140	-139	-134	-124	-114	-106	-100	-92	-84	-76
4540	-66	-56	-46	-36	-26	-25	-25	-33	-36	-45
4550	-56	-66	-79	-91	-104	-114	-124	-129	-133	-130
4560	-126	-124	-114	-101	-86	-71	-46	-21	-2	26
4570	57	76	97	102	111	118	123	120	112	102
4580	91	79	73	62	53	43	35	24	16	9
4590	0	-7	-15	-20	-16	-16	-16	-16	-11	-11
4600	-15	-14	-14	-15	-10	-9	-5	-4	-5	-5
4610	-6	-11	-13	-16	-21	-21	-22	-22	-22	-22
4620	-21	-31	-37	-40	-37	-30	-19	-4	17	29
4630	38	42	43	38	32	24	17	7	-2	-7
4640	-15	-19	-20	-16	-16	-11	-6	-6	-6	-5
4650	-3	-2	12	19	28	33	37	36	32	24
4660	17	7	10	5	-11	-11	-16	-16	-15	-11
4670	-10	-5	-2	-2	-2	-5	-10	-20	-21	-21
4680	-16	-6	2	17	29	38	44	47	46	43
4690	38	38	40	43	48	52	57	56	56	52
4700	42	32	17	-2	-6	-16	-24	-32	-34	-36
4710	-36	-31	-25	-16	-6	0	2	-1	-3	-23
4720	-33	-40	-41	-40	-36	-35	-31	-33	-35	-45
4730	-51	-61	-65	-70	-66	-69	-61	-61	-56	-50
4740	-42	-51	-51	-46	-44	-44	-44	-44	-44	-44
4750	-2	7	19	32	44	56	66	72	67	63
4760	54	44	34	27	19	14	12	7	5	7
4770	14	19	24	33	43	52	66	76	82	83
4780	82	77	74	72	65	62	56	53	52	45
4790	44	42	37	29	24	14	2	-4	-10	-20
4800	-20	-20	-15	-6	9	19	24	32	37	37

TO BE CONTINUED

TO BE CONTINUED

CONTINUED (F-98) E16N)										
NO.	(1)	(2)	(3)	(4)	(5)	(6)	(7)	(8)	(9)	(10)
5350	19	22	25	29	34	41	49	59	72	82
5360	97	102	112	116	123	127	130	133	137	138
5370	138	134	132	123	117	108	98	87	74	62
5380	49	28	26	22	13	6	7	6	14	20
5390	24	29	31	32	25	18	7	-1	-11	-20
5400	-21	-20	-11	-2	11	20	38	52	62	67
5410	69	66	62	55	52	43	38	35	32	27
5420	24	17	7	0	-6	-11	-18	-20	-21	-26
5430	-31	-37	-45	-52	-61	-75	-86	-96	-104	-109
5440	-109	-106	-100	-90	-84	-72	-66	-66	-64	-71
5450	-81	-83	-82	-96	-98	-96	-94	-86	-84	-76
5460	-66	-61	-55	-46	-45	-40	-36	-36	-35	-35
5470	-35	-34	-33	-31	-24	-24	-20	-15	-10	-5
5480	-4	-2	4	12	17	24	29	33	36	36
5490	35	31	29	29	27	24	29	32	34	36
5500	46	48	49	54	57	59	63	64	67	66
5510	67	68	68	72	72	72	73	72	68	62
5520	52	38	24	9	-2	-5	-6	-5	-3	-2
5530	-2	9	14	17	19	21	23	19	17	14
5540	9	7	5	9	17	22	32	34	38	33
5550	24	14	0	-11	-21	-31	-35	-35	-37	-36
5560	-35	-30	-30	-21	-21	-20	-20	-20	-21	-26
5570	-30	-34	-40	-36	-42	-45	-46	-46	-51	-52
5580	-50	-49	-46	-40	-36	-36	-35	-30	-24	-21
5590	-16	-15	-13	-15	-16	-22	-26	-35	-40	-45
5600	-46	-46	-47	-41	-36	-32	-26	-20	-16	-15
5610	-15	-12	-10	-6	-2	9	19	24	36	42
5620	46	47	44	38	32	24	18	17	11	12
5630	13	17	22	21	19	12	0	-14	-25	-36
5640	-46	-54	-55	-50	-42	-35	-26	-22	-15	-13
5650	-10	-11	-13	-14	-13	-9	-3	4	14	22
5660	34	47	54	64	72	73	76	76	74	64
5670	57	43	33	21	9	0	-6	-16	-25	-35
5680	-40	-41	-42	-41	-36	-31	-25	-15	-1	2
5690	11	14	17	15	12	9	5	0	-1	-6
5700	-10	-6	-5	-5	2	2	-2	4	4	9
5710	11	14	18	22	27	32	37	38	43	43
5720	47	52	52	53	56	62	63	63	63	64
5730	63	63	59	57	52	42	38	29	19	7
5740	-2	-10	-21	-26	-35	-41	-46	-55	-61	-61
5750	-61	-70	-76	-76	-82	-86	-86	-90	-92	-95
5760	-100	-105	-112	-116	-119	-124	-124	-124	-123	-123
5770	-124	-122	-124	-124	-121	-119	-114	-111	-107	-101
5780	-97	-86	-76	-61	-46	-35	-25	-15	-3	-2
5790	9	13	19	22	27	33	39	50	56	64
5800	73	83	87	78	75	72	71	67	67	92
5810	86	87	78	75	72	71	67	67	69	72
5820	76	83	92	94	96	102	96	97	87	82
5830	78	77	72	69	67	66	64	61	63	63
5840	62	62	62	59	62	62	63	62	62	57
5850	53	47	42	32	24	18	11	4	-2	-5
5860	-10	-11	-16	-16	-25	-26	-36	-45	-51	-55
5870	-60	-61	-65	-70	-74	-81	-85	-93	-100	-109
5880	-112	-119	-120	-126	-131	-135	-135	-135	-135	-135

TO BE CONTINUED

END

RECORD = F-98 COMPONENT = UP STATION = KAWASAKI-F
 DATE AND TIME = 1987-12-17-11-08 TOTAL NUMBER OF DATA = 6000
 SAMPLING INTERVAL = 0.010 (SEC) SCAL = 0.10000
 SIGNAL = GR. ACC.

CONTINUED (F-98 UP)

NO.	(1)	(2)	(3)	(4)	(5)	(6)	(7)	(8)	(9)	(10)
490	-1	0	0	0	0	2	0	0	1	0
500	-1	0	0	0	0	2	0	-1	0	2
510	2	1	2	2	0	2	2	0	0	2
520	0	0	2	2	2	2	2	0	2	0
530	2	0	2	2	2	-1	0	0	0	0
540	0	0	0	1	2	0	0	0	0	-1
550	2	0	0	2	2	0	0	0	0	0
560	0	0	0	2	-1	0	0	0	0	0
570	2	2	2	-1	0	2	2	0	0	2
580	1	2	2	2	2	2	3	0	0	2
590	0	2	0	2	0	0	2	0	0	0
600	2	2	0	2	2	2	2	-1	2	-1
610	1	0	0	0	2	2	1	-2	0	0
620	1	0	2	0	2	2	1	-1	0	0
630	-1	2	0	-1	-1	1	2	0	0	-1
640	0	2	2	2	0	2	2	2	0	1
650	0	2	2	2	-1	0	2	2	0	0
660	2	2	2	2	2	2	2	0	0	2
670	2	0	0	2	0	2	0	0	1	2
680	0	-1	0	0	2	0	2	0	0	2
690	0	0	2	2	1	0	2	0	0	1
700	-1	0	2	2	2	0	2	2	2	-1
710	1	2	0	2	0	1	0	2	2	0
720	0	2	0	2	-2	0	0	2	0	0
730	0	0	0	2	2	2	2	2	2	2
740	0	0	0	2	2	2	2	2	2	2
750	2	3	2	2	2	2	3	1	2	0
760	2	0	0	2	2	0	2	2	2	2
770	0	0	2	2	0	1	0	2	0	2
780	0	2	0	2	3	0	2	2	2	-1
790	2	2	0	2	1	2	2	0	0	0
800	-1	2	0	0	0	2	0	0	0	0
810	2	2	0	2	2	1	0	2	0	0
820	2	2	0	0	2	2	2	2	2	0
830	0	0	2	1	1	0	2	0	0	1
840	0	2	2	2	0	-2	0	2	0	-1
850	3	1	2	2	0	0	-2	2	0	2
860	1	3	3	2	-1	2	2	-2	2	0
870	1	2	3	3	2	1	4	7	7	2
880	2	2	1	8	2	2	0	0	2	1
890	22	14	13	8	22	12	12	17	22	22
900	12	22	22	22	19	19	22	13	22	11
910	3	2	0	2	7	22	11	8	3	0
920	18	33	28	12	-13	22	22	0	0	2
930	-17	-17	-12	-16	-25	-32	-35	-21	-10	-11
940	-27	-32	-31	-18	13	-32	-36	-37	-38	-30
950	58	27	-22	-18	46	46	68	74	62	48
960	-47	-74	-76	-46	-43	-42	-25	2	12	-10
970	37	2	-12	-11	-12	-10	-16	-10	22	47
980	-41	-6	46	102	-11	-8	-26	-41	-57	-57
990	117	163	171	132	142	143	108	67	47	63
1000	22	22	23	22	67	23	23	41	41	23
1010	-132	-110	-80	-82	-130	8	7	-26	-87	-127
1020	-112	-95	-71	-47	-52	-192	-27	-26	-176	-133
						-27	-31	-26	-14	1

TO BE CONTINUED

TO BE CONTINUED

CONTINUED(F-98 UP)

CONTINUED(F-98 UP)

NO.	(1)	(2)	(3)	(4)	(5)	(6)	(7)	(8)	(9)	(10)
1030	16	13	-6	-33	-47	-41	-36	-22	2	42
1040	78	94	92	88	102	133	133	110	107	107
1050	97	51	-12	-81	-137	-157	-195	-96	-55	-55
1060	-42	-60	-102	-135	-70	-2	33	17	-12	-12
1070	-12	2	17	28	49	52	33	38	79	108
1080	73	27	-32	-62	1080	0	68	113	118	102
1090	87	57	63	87	43	8	13	39	51	51
1100	47	31	7	-10	-21	-39	-59	-86	-127	-167
1110	-152	-100	-28	57	127	133	122	87	158	27
1120	53	17	68	118	157	53	-47	-129	-167	-158
1130	-107	-51	-10	1	-11	-16	-10	-2	-10	-10
1140	-13	-6	-8	-42	-91	-132	-142	-102	-12	79
1150	128	107	27	-52	-71	-32	8	47	80	117
1160	138	133	118	108	91	48	0	-30	-47	81
1170	-113	-142	-162	-171	-157	-122	-60	24	112	127
1180	53	-53	-106	-52	61	121	97	22	-48	-72
1190	-41	13	58	52	17	-11	-11	2	13	-1
1200	-28	-62	-97	-101	-71	-8	63	118	152	161
1210	141	113	107	104	62	-23	-87	-81	-48	-27
1220	-22	-30	-46	-61	-57	-22	41	27	-22	27
1230	-62	-52	18	115	160	113	23	-28	-20	8
1240	31	48	70	80	83	118	133	150	61	-60
1250	-137	-192	-176	-119	-51	-20	-32	-48	-56	-37
1260	12	78	107	73	17	13	58	79	57	2
1270	-62	-107	-111	-86	-57	-40	-21	-14	-38	-68
1280	-66	-40	-12	0	9	38	80	108	107	77
1290	41	18	32	96	163	157	48	-107	-230	-265
1300	-14	-15	-10	57	78	61	74	87	51	51
1310	-28	-81	-25	105	183	157	87	38	22	-2
1320	-70	-137	-160	-145	-112	-91	-92	-91	-66	-17
1330	57	123	153	138	112	87	62	28	-15	-62
1340	-92	-92	-67	-22	24	68	79	68	53	42
1350	24	-8	-42	-57	-72	-110	-137	-110	-51	-10
1360	-16	-42	-45	-7	39	82	108	102	41	-29
1370	-120	-132	-102	-52	15	13	-7	1	29	1
1380	58	72	62	-16	-52	-46	-3	42	37	-20
1390	-88	-99	-52	1	47	72	73	61	56	14
1400	22	34	53	1	-52	-76	-62	62	107	87
1410	27	-2	-1	2	3	2	32	63	77	33
1420	-17	-26	-12	23	74	98	77	27	-21	-56
1430	-7	22	26	23	37	75	117	148	137	37
1440	-110	-215	-230	-152	-42	23	29	-12	-5	-101
1450	-97	-95	-88	-62	-7	67	73	67	38	27
1460	25	0	-22	-12	28	52	40	9	-11	-53
1470	-57	-57	-22	-2	-11	-32	-22	2	18	22
1480	22	22	9	7	9	-12	-56	-27	-82	-82
1490	8	18	7	2	0	-27	-37	22	69	-2
1500	89	100	102	71	29	2	-1	-2	-22	-48
1510	-55	-36	-12	33	92	132	127	79	28	2
1520	29	43	28	0	-32	-72	-67	-62	-2	52
1530	68	41	-2	-37	-17	46	98	114	80	17
1540	-37	-62	-80	-111	-145	-160	-148	-102	-61	-59
1550	-8	48	108	127	93	51	44	80	138	161
1560	123	47	-36	-89	-92	-61	-18	13	1	-55

TO BE CONTINUED

TO BE CONTINUED

CONTINUED (F-98

UP

CONTINUED (F-98

UP

NO.	(1)	(2)	(3)	(4)	(5)	(6)	(7)	(8)	(9)	(10)
2110	80	79	81	93	88	74	79	117	174	230
2120	257	250	238	243	248	223	167	89	28	-2
2130	-1	2	-7	-22	-42	-42	-22	-5	22	41
2140	63	83	92	90	108	117	119	128	141	157
2150	163	166	157	127	72	22	-12	-38	-39	-17
2160	2	7	0	-11	-48	-78	-120	-167	-211	-230
2170	-210	-172	-137	-215	-95	-68	-42	-38	-57	-100
2180	-140	-177	-205	-216	-205	-177	-130	-67	-12	37
2190	71	93	114	123	108	78	27	-40	-97	-120
2200	-137	-155	-177	-202	-216	-208	-172	-120	-57	-7
2210	24	57	102	112	120	104	67	23	-10	-39
2220	-72	-101	-105	-99	-79	-41	-6	38	102	151
2230	194	228	248	261	228	165	63	-42	-107	-137
2240	-148	-130	-112	-97	-67	-38	9	93	179	240
2250	246	213	185	171	176	178	158	110	63	63
2260	33	27	2	2	2	39	79	117	148	169
2270	182	188	178	142	81	18	-62	-125	-182	-216
2280	-230	-216	-207	-182	-122	-117	-112	-72	68	-11
2290	-62	77	-2	-38	-66	-95	-47	21	48	40
2300	18	3	22	60	128	113	57	-2	-17	-2
2310	-31	-61	-91	-102	-81	-42	-17	-4	-27	-57
2320	-75	-96	-92	-78	-67	-62	-62	-57	-52	-46
2330	-17	12	39	68	79	77	57	27	-12	-40
2340	-45	-42	-32	-35	-47	-70	-91	-100	-81	-41
2350	6	38	52	63	90	118	128	112	93	92
2360	83	58	11	-40	-71	-78	-79	-77	-57	-50
2370	-41	-31	-15	-2	23	48	67	47	4	-2
2380	-97	-125	-140	-147	-142	-132	-122	-96	-58	-15
2390	32	87	139	161	148	121	98	74	57	33
2400	-2	-55	-103	-137	-160	-161	-150	-128	-106	-75
2410	-32	22	73	107	122	123	102	87	92	107
2420	114	104	72	39	22	2	-8	-27	-46	-62
2430	-77	-89	-82	-56	-32	-25	-20	-17	-22	-28
2440	-12	-6	-16	-41	-77	-112	-122	-101	-51	0
2450	38	52	33	8	-2	-12	-6	-1	-6	-21
2460	-42	-55	-62	-63	-48	-17	10	12	3	2
2470	23	38	58	38	35	37	22	2	-12	-20
2480	1	22	21	18	8	-17	-42	-57	-77	-78
2490	-52	-12	23	43	62	87	112	132	132	127
2500	127	137	148	145	118	82	47	16	1	2
2510	18	37	43	43	41	33	22	3	3	8
2520	13	23	29	32	43	58	53	33	1	-42
2530	-81	-101	-118	-125	-111	-75	-22	13	24	18
2540	1	-16	-38	-48	-44	-42	-48	-61	-72	-77
2550	-68	-62	-74	-101	-128	-145	-140	-121	-99	-72
2560	-41	0	47	102	148	191	208	189	158	128
2570	103	79	52	28	12	-2	-23	-42	-55	-60
2580	-57	-47	-41	-28	-1	37	64	73	68	51
2590	36	11	-31	-82	-139	-191	-215	-205	-167	-116
2600	-57	-2	46	80	108	137	147	124	92	72
2610	53	23	-10	-55	-90	-102	-99	-96	-112	-142
2620	-160	-160	-137	-112	-91	-68	-53	-32	-5	29
2630	56	62	57	38	13	-2	-11	-30	-48	-58
2640	-46	-27	-20	-35	-52	-57	-45	-15	17	57

TO BE CONTINUED

TO BE CONTINUED

CONTINUED (F-98

UP

)

)

)

)

)

)

)

)

)

)

)

)

)

)

)

)

)

)

)

)

)

)

NO.	(1)	(2)	(3)	(4)	(5)	(6)	(7)	(8)	(9)	(10)
3190	-2	11	17	17	11	-15	-20	-16	-21	-2
3200	-28	-27	-15	-11	13	17	28	38	42	-36
3210	38	43	57	81	108	127	137	137	125	-40
3220	102	81	68	62	56	49	38	22	-21	62
3230	-51	-72	-80	-80	-77	-75	-67	-59	-53	49
3240	-46	-36	-21	-12	-2	0	8	17	11	27
3250	0	-11	-21	-31	-36	-37	-38	12	32	48
3260	-47	-37	-30	-22	-15	-2	4	-1	-12	38
3270	-27	-32	-33	-27	-16	-7	8	1	-12	-97
3280	48	67	77	77	67	57	62	58	41	-102
3290	22	-1	-1	1	2	11	17	32	58	-51
3300	77	82	77	67	52	38	27	17	22	-53
3310	-28	3310	-32	-42	-48	-55	-62	-62	-62	-57
3320	-56	-51	-52	-59	-77	-86	-75	-57	-47	-51
3330	-50	-62	-66	-66	-57	-52	-47	-42	-32	-57
3340	-17	0	13	23	32	48	58	53	38	27
3350	10	9	12	16	12	17	28	68	19	-30
3360	65	78	87	85	78	77	70	58	47	-78
3370	23	17	12	8	2	-2	-16	-35	-51	-77
3380	-40	-30	-12	-11	-7	-16	-20	-12	-7	-88
3390	-10	-8	-10	-11	-20	-25	-29	-30	-30	-88
3400	-12	1	13	23	27	19	-2	-26	-42	-78
3410	-47	-36	-27	-30	-38	-42	-45	-40	-28	-78
3420	-31	-26	-17	-7	-6	-2	7	27	66	-78
3430	88	74	77	68	62	47	36	28	52	-46
3440	37	28	22	2	1	-10	-17	-27	-26	-78
3450	-27	-21	-12	2	12	13	7	-1	-6	-78
3460	9	18	13	7	-2	-12	-12	-17	-21	-78
3470	-27	-38	-48	-32	-52	-55	-61	-62	-68	-78
3480	-75	-62	-68	-40	-21	-12	-2	9	19	-78
3490	35	55	70	83	88	92	103	102	81	-78
3500	14	-6	-18	-27	-28	-32	-32	-33	-35	-78
3510	-17	-12	-15	-17	-17	-12	-11	-16	-36	-78
3520	-42	-45	-47	-52	-50	-47	-47	-46	-42	-78
3530	-41	-33	-20	-2	2	2	2	-1	-1	-78
3540	0	-2	-5	1	13	28	37	43	44	-78
3550	52	56	61	66	66	74	71	71	68	-78
3560	42	28	9	0	-5	-2	3	13	11	-78
3570	-2	-11	-12	-10	-1	2	6	17	28	-78
3580	38	37	37	45	62	74	81	87	77	-78
3590	27	2	-10	-22	-34	-45	-50	-45	-30	-78
3600	-11	2	8	22	18	2	-15	-30	-36	-78
3610	-36	-42	-52	-56	-60	-57	-52	-47	-37	-78
3620	-37	-31	-18	-5	2	3	2	17	26	-78
3630	36	45	45	37	28	18	12	11	12	-78
3640	22	22	23	22	16	6	-11	-22	-35	-78
3650	-35	-35	-36	-38	-36	-35	-35	-36	-46	-78
3660	-66	-76	-75	-67	-54	-38	-17	3	38	-78
3670	77	72	57	37	18	2	2	2	1	-78
3680	0	2	13	22	29	41	44	49	57	-78
3690	78	83	78	67	53	48	43	41	37	-78
3700	23	22	17	22	17	9	0	-7	-12	-78
3710	-10	-11	-21	-32	-50	-65	-95	-96	-90	-78
3720	-87	-95	-98	-100	-100	-92	-81	-68	-57	-78

TO BE CONTINUED

TO BE CONTINUED

NO.	(1)	(2)	(3)	(4)	(5)	(6)	(7)	(8)	(9)	(10)
4270	-30	-28	-28	-25	-23	-22	-26	-27	-22	-22
4280	-21	-21	-17	-10	-1	0	3	0	-5	-7
4290	-7	-3	-1	-1	0	0	4	4	11	13
4300	17	16	13	17	17	12	12	2	2	13
4310	17	14	17	17	22	28	37	43	47	48
4320	47	41	32	18	-10	-17	-16	-16	-12	-11
4330	-11	-15	-20	-27	-30	-30	-30	-32	-38	-38
4340	-46	-48	-51	-48	-42	-40	-40	-37	-32	-28
4350	-23	-17	-11	-8	-10	-12	-21	-21	-18	-12
4360	-10	-2	-1	-1	-1	-1	-1	0	0	-2
4370	-7	-11	-12	-10	-8	-2	2	17	32	38
4380	48	63	72	73	69	67	64	62	62	58
4390	51	47	42	37	31	27	23	17	8	0
4400	-8	-12	-17	-21	-21	-17	-12	-10	-12	-14
4410	-17	-12	-10	-2	-2	-6	-8	-6	-8	-10
4420	-11	-17	-27	-35	-39	-42	-51	-57	-66	-70
4430	-67	-57	-54	-50	-45	-42	-38	-32	-27	-21
4440	-12	-17	-11	-10	-10	-6	-7	-2	-2	7
4450	19	33	47	47	52	58	62	59	52	39
4460	28	13	1	-7	-11	-10	-10	-10	-12	-16
4470	-32	9	22	24	27	27	21	27	28	31
4480	33	38	33	35	32	28	27	23	18	13
4490	12	8	2	-1	-1	-1	-1	-5	-10	-11
4500	-7	0	0	0	-6	-12	-12	-10	-11	-10
4510	-7	-7	-8	-5	-1	-1	-1	-2	2	2
4520	2	12	16	22	22	23	22	18	17	11
4530	6	2	2	3	12	12	8	0	-11	-18
4540	-21	-25	-28	-30	-30	-22	-21	-21	-28	-28
4550	-17	-17	-22	-25	-27	-27	-31	-32	-28	-28
4560	-28	-31	-32	-30	-27	-26	-23	-23	-21	-17
4570	-17	-11	-1	2	13	12	8	2	14	17
4580	18	17	22	19	22	27	32	32	31	27
4590	22	18	17	22	24	29	27	23	19	11
4600	12	17	22	17	12	2	2	2	17	17
4610	18	17	17	13	12	17	17	13	8	8
4620	8	4	2	2	7	2	13	23	26	32
4630	37	44	57	57	53	40	27	17	8	2
4640	2	2	0	-1	-1	2	6	6	2	2
4650	2	-1	-5	-2	2	2	17	23	25	28
4660	32	41	57	63	67	61	48	38	31	28
4670	27	23	27	37	39	39	39	34	27	27
4680	22	9	2	0	-2	-12	-17	-26	-32	-41
4690	-45	-42	-42	-45	-47	-51	-55	-55	-56	-52
4700	-51	-50	-50	-46	-47	-50	-51	-57	-62	-62
4710	-57	-56	-57	-61	-61	-61	-57	-52	-46	-41
4720	-38	-32	-32	-27	-21	-16	-12	-6	-3	-5
4730	-2	2	2	3	0	0	-2	-1	0	1
4740	-1	-2	-2	-1	7	18	26	33	37	38
4750	41	47	57	63	63	63	67	63	61	68
4760	77	77	77	68	63	59	57	48	38	29
4770	22	8	3	0	-2	-8	-15	-26	-31	-40
4780	-66	-67	-61	-51	-49	-48	-41	-36	-27	-18
4790	-12	-12	-10	-2	1	1	2	2	1	-1
4800	-5	-11	-11	-15	-15	-15	-17	-20	-20	-20

TO BE CONTINUED

TO BE CONTINUED

CONTINUED(F-98 UP)										
NO.	(1)	(2)	(3)	(4)	(5)	(6)	(7)	(8)	(9)	(10)
5350	42	43	38	37	31	28	27	24	23	22
5360	15	0	2	-5	0	2	2	1	-1	-2
5370	-2	0	2	-1	3	0	-2	2	2	3
5380	3	0	-2	3	3	3	3	5	3	3
5390	2	2	4	0	2	-7	-10	-11	-13	-12
5400	-15	-17	-18	-22	-23	-26	-28	-27	-30	-28
5410	-27	-22	-22	-31	-35	-36	-32	-28	-27	-27
5420	-27	-28	-22	-22	-22	-20	-17	-18	-16	-17
5430	-20	-22	-26	-20	-18	-8	-1	1	6	8
5440	12	13	17	18	18	22	23	23	27	27
5450	28	29	32	37	37	37	38	37	39	41
5460	42	43	47	47	43	42	38	33	31	27
5470	28	27	28	28	31	34	34	37	38	37
5480	32	28	27	28	28	27	32	32	33	33
5490	31	32	27	22	17	12	2	-1	-10	-20
5500	-30	-37	-42	-47	-48	-47	-50	-48	-46	-45
5510	-42	-41	-40	-37	-31	-27	-21	-21	-20	-20
5520	-17	-11	-12	3	8	13	14	13	13	13
5530	13	17	16	23	27	32	38	37	37	37
5540	33	28	27	27	25	18	16	12	8	2
5550	2	13	17	18	18	17	17	12	2	2
5560	2	1	-2	-2	-2	-2	-2	-8	-12	-11
5570	-11	-10	-7	-7	-8	-8	-10	-10	-12	-12
5580	-12	-11	-10	-7	-7	-11	-12	-12	-12	-12
5590	-7	-3	-2	-4	-8	-11	-16	-15	-12	-13
5600	-6	3	2	17	22	23	28	37	43	49
5610	50	48	47	43	43	41	39	33	28	32
5620	33	37	37	32	28	27	23	19	17	13
5630	11	14	13	17	15	18	22	27	31	32
5640	32	29	24	18	13	17	8	2	2	3
5650	2	2	2	2	1	-1	-5	-12	-17	-25
5660	-32	-38	-45	-46	-47	-51	-51	-55	-52	-52
5670	-52	-50	-48	-46	-41	-36	-30	-17	-21	-16
5680	-13	-12	-17	-18	-17	-15	-18	-20	-22	-22
5690	-6	-9	-10	-27	-29	-31	-30	-27	-17	-20
5700	-15	-12	-12	-1	2	9	12	11	7	7
5710	7	3	3	4	8	8	11	11	12	9
5720	8	12	11	12	12	8	8	6	3	2
5730	-1	-3	-5	-2	-2	-1	-7	-10	-15	-12
5740	-17	-16	-11	-22	-27	-31	-32	-32	-32	-32
5750	-28	-27	-26	-25	-21	-22	-27	-27	-28	-22
5760	-22	-21	-22	-21	-20	-18	-17	-17	-15	-12
5770	-11	-8	-8	-7	-12	-17	-20	-22	-22	-22
5780	-22	-21	-22	-23	-17	-15	-12	-6	-2	-1
5790	2	2	18	23	27	27	27	23	23	28
5800	33	32	32	33	38	41	41	47	49	47
5810	52	57	57	58	57	57	53	51	48	47
5820	43	43	42	38	37	31	32	28	31	26
5830	22	17	8	5	-5	-10	-17	-22	-26	-30
5840	-36	-36	-60	-45	-50	-48	-52	-53	-52	-53
5850	-21	-57	-56	-56	-52	-52	-52	-51	-50	-46
5860	-42	-42	-42	-42	-45	-41	-40	-37	-36	-30
5870	-26	-25	-21	-20	-16	-12	-11	-7	-8	-2
5880	0	1	2	2	2	2	1	1	2	0

TO BE CONTINUED

END

港湾技研資料 No.619

1988・6

編集兼発行人 運輸省港湾技術研究所

発行所 運輸省港湾技術研究所
横須賀市長瀬3丁目1番1号

印刷所 新宿総合印刷センター協業組合

Published by the Port and Harbour Research Institute
Nagase, Yokosuka, Japan.